

General Specifications

GS 01E20D01-01E

AXF
Magnetic Flowmeter
Integral Flowmeter
/Remote Flowtube



The AXF magnetic flowmeter series are sophisticated products with outstanding reliability and ease of operation, developed on the basis of decades of field-proven experience.

The combination of a replaceable electrode and the diagnostic to defect adhesion level on the electrodes dramatically improves maintainability.

The AXF employs the fluid noise free “Dual Frequency Excitation Method” and the newly added “Enhanced Dual Frequency Excitation Method” as an option for more difficult applications to ensure greater stability and quicker response.

Note: The “Dual Frequency Excitation Method” is Yokogawa’s unique technology.

Fieldbus communication type is also available.

Refer to GS 01E20F02-01E for FOUNDATION™ Fieldbus communication type and GS 01E20F12-01E for PROFIBUS PA communication type regarding the items marked with “◇”.

■ FEATURES

● User-oriented Functionality

Fluid Adhesion Level Diagnosis

By constantly monitoring the level of insulating substance on the electrodes, it is possible to determine when maintenance is required.

With the utilization of an optional replaceable electrode, the electrodes can be easily removed from the flowmeter and cleaned.

Flexible Electrical Connection Direction

The converter or the terminal box can be rotated arbitrarily to change the directions of electrical connection on the site.

Clear and Versatile Indications

The LCD indicator employs a large, backlit full dot-matrix, that can facilitate various displays.

One to three lines are available. When there is an alarm condition, a full description of the countermeasure is indicated.

“Easy Setup” Parameters “◇”

The most frequently used parameters are arranged in a group at the top.

The infra-red switches enable the users to set parameters without opening the cover.

● Expansion of Product Lineup

Improved Accuracy Specification

The standard accuracy is 0.35% of reading. Also available is an optional high accuracy calibration rated at 0.2% of reading.



Integral Flowmeter

Remote Flowtube

Extra Small Size Flange Type

The flange type is now available from a 2.5 mm size.

Various Sanitary Connections

A variety of sanitary connections are available, such as Tri-Clamp, ISO, DIN and SMS.

● Enhanced Performance and Specifications

Enhanced Dual Frequency Excitation Method

The “Enhanced Dual Frequency Excitation Method” can be optionally selected.

For difficult applications such as for high concentration slurries or low conductivity fluid, extremely stable measurements can be realized.

Improved Minimum Conductivity

The newly designed AXF converter permits the measurement of fluids with conductivity as low as 1μS/cm.

High-Speed Pulse Output “◇”

The pulse rate now goes up to 10,000 pps (pulse/second) for use with high speed applications such as in short time batch processes.

Versatile Input/Output Function for Integral Flowmeter “◇”

Integral type is also equipped with versatile input/output function.

CONTENTS

Features	P. 1
Standard Specifications	P. 2
Hazardous Area Classification	P.12
Standard Performance	P.16
Normal Operating Conditions	P.18
Cautions for Installation	P.22
Accessories	P.23
Terminal Configuration and Terminal Wiring	P.23
Model and Suffix Code	P.24
Optional Specifications for Flowtubes	P.35
External Dimensions	P.40
Sizing Data	P.56
Ordering Information	P.57

■ STANDARD SPECIFICATIONS

● Converter (Integral flowmeter)

The contents of (*1) and (*2) described in the converter specifications are follows.

- *1: Select two points from: one pulse output, one alarm output, one status input, or two status outputs.
- *2: For models without an indicator, the configuration tool (Such as HHT (handheld terminal) or FieldMate™ etc.) is necessary to set parameters.

Excitation Method:

- Standard dual frequency excitation:
Size 2.5 to 400 mm (0.1 to 16 in.)
- Enhanced dual frequency excitation:
Size 25 to 200 mm (1.0 to 8.0 in.)
(Optional code HF1 or HF2)

Input Signal (*1) “◇”:

One Status Input: Dry contact
Load Resistance: 200 Ω or less (ON), 100 kΩ or more (OFF)

Output Signals “◇”:

- One Current Output: 4 to 20 mA DC (load resistance: 750Ω maximum, including cable resistance)
- One Pulse Output (*1):
Transistor contact output (open collector)
Contact capacity: 30 V DC (OFF), 200 mA (ON)
Output rate: 0.0001 to 10,000 pps (pulse/second)
- One Alarm Output (*1):
Transistor contact output (open collector)
Contact capacity: 30 V DC (OFF), 200 mA (ON)
- Two Status Outputs (*1):
Transistor contact output (open collector)
Contact capacity: 30 V DC (OFF), 200 mA (ON)

Communication Signals “◇”:

BRAIN or HART communication signal
(Superimposed on the 4 to 20 mA DC signal)
Distance from Power Line: 15 cm (6 in.) or more
(Parallel wiring should be avoided.)

BRAIN:

Communication Distance:

Up to 1.5 km (0.93 miles), when polyethylene insulated PVC-sheathed cables (CEV cables) are used.
Communication distance varies depending on the type of cable and wiring used.

Load Resistance:

250 to 450Ω (including cable resistance)

Load Capacitance:

0.22 μF or less

Load Inductance:

3.3 mH or less

Input Impedance of Communicating Device:

10 kΩ or more (at 2.4 kHz)

HART:

Load Resistance:

250 to 600Ω (including cable resistance)
Note: HART is a registered trademark of the HART Communication Foundation.

Data Security During Power Failure:

Data (parameters, totalizer value, etc.) storage by EEPROM. No back-up battery required.

Indicator (*2):

Full dot-matrix LCD (32×132 pixels)

Lightning Protector:

The lightning protector is built into the current output and pulse/alarm/status input and output terminals. When optional code A is selected, the lightning protector is built into the power terminals.

Protection:

General-purpose Use/Sanitary Type/TIIS Flameproof type:

IP66, IP67

Explosion proof type except TIIS:

In case of explosion proof type except TIIS, refer to description of "Enclosure" in "HAZARDOUS AREA CLASSIFICATION".

Coating:

Case and Cover: Corrosion-resistant coating
Coating Color: Mint green coating (Munsell 5.6 BG 3.3/2.9 or its equivalent)

Converter Material:

Case and Cover : Aluminum alloy

Mounting/Shapes (Integral Flowmeter):

- Electrical Connection: ANSI 1/2 NPT female
ISO M20 ×1.5 female
JIS G1/2 female
- Direction of Electrical Connection: The direction can be changed even after delivery.
- Terminal Connection: M4 size screw terminal

Grounding:

Grounding resistance 100 Ω or less
When optional code A is selected, grounding resistance 10 Ω or less shall be applied.

* In case of explosion proof type except TIIS, follow the domestic electrical requirements as regulated in each country.

* In case of TIIS Flameproof type, refer to description of "HAZARDOUS AREA CLASSIFICATION".

Functions “◇”

How to Set Parameters (*2):

The indicator's LCD and three infra-red switches enable users to set parameters without opening the case cover. Parameters can also be set with the configuration tool (Such as HHT (handheld terminal) or FieldMate, etc.). The language for the HHT is English only.

Displayed Languages (*2):

Users can choose a language from among English, Japanese, German, French, Italian, and Spanish.

Instantaneous Flow Rate/Totalized Value Display Functions (for models with an indicator) (*2):

The full dot-matrix LCD enables user selections of displays from one line to three lines for:

- Instantaneous flow rate
- Instantaneous flow rate (%)
- Instantaneous flow rate (bar graph)
- Current output value (mA)
- Totalized forward-direction flow rate
- Totalized reverse-direction flow rate
- Totalized differential flow rate
- Tag No.
- Results of electrode adhesion diagnostics
- Communication type

Totalizer Display Function (*2):

The flow rate is counted one pulse at a time according to the setting of totalization pulse weights. For forward and reverse flow measurement functions, the totalized values of the flow direction (forward or reverse) and the flow direction are displayed on the indicator together with the units. The difference of totalized values between the forward and reverse flow rate can be displayed. Totalization for the reverse flow rate is carried out only when "Forward and reverse flow measurement functions" is selected.

Damping Time Constant (*2):

Time constant can be set from 0.1 second to 200.0 seconds (63% response). The default is 3 seconds.

Span Setting Function (*2):

Span flows can be set in units such as volume flow rate, mass flow rate, time, or flow rate value. The velocity unit can also be set.

Volume Flow Rate Unit: kcf, cf, mcf, Mgal (US), kgal (US), gal (US), mgal (US), kbbbl (US)*, bbl (US)*, mbbbl (US)*, μbbbl (US)*, Ml (megaliter), m³, kl (kiloliter), l (liter), cm³

Mass Flow Rate Unit (Density must be set.):
klb (US), lb (US), t (ton), kg, g

Velocity Unit: ft, m (meter)

Time Unit: s (sec), min, h (hour), d (day)

* "US oil" or "US Beer" can be selected.

Pulse Output (*1)(*2):

Scaled pulse can be output by setting a pulse weight.

Pulse Width: Duty 50% or fixed pulse width (0.05, 0.1, 0.5, 1, 20, 33, 50, 100 ms) can be selected.

Output Rate: 0.0001 to 10,000 pps (pulse/second)

Multi-range Function (*1)(*2):

- Range switching via status input
Status input enables the switching of up to two ranges.
- Automatic range switching
When the flow rate exceeds 100 % of the range, transition to the next range (up to four ranges) is carried out automatically. Range switching can be confirmed by status outputs and indicator.

Forward and Reverse Flow Measurement Functions (*1)(*2):

Flows in both forward and reverse directions can be measured. The reverse flow measurement can be confirmed by status output and indicator.

Totalization Switch (*1)(*2):

The status output is carried out when a totalized value becomes equal to or greater than the set value.

Preset Totalization (*1)(*2):

The parameter setting or status input enables a totalized value to be preset to a setting value or zero.

0% Signal Lock (*1)(*2):

Status input forcibly fixes the instantaneous flow rate display, current output, pulse output, and flow rate totalization to 0%.

Alarm Selection Function (*2):

Alarms are classified into the System Alarms (hard failures), Process Alarms (such as 'Empty Pipe', 'Signal Overflow' and 'Adhesion Alarm'), Setting Alarms, and Warnings.

Whether alarms should be generated or not can be selected for each item.

The current output generated for an alarm can be selected from among 2.4 mA or less, fixed to 4 mA, 21.6 mA or more, or HOLD.

Alarm Output (*1)(*2):

Alarms are generated only for the items selected via the 'Alarm Selection Function' if relevant failures occur.

Self Diagnostics Functions (*2):

If alarms are generated, details of the System Alarms, Process Alarms, Setting Alarms and Warnings are displayed together with concrete descriptions of countermeasures.

Flow Upper/Lower Limit Alarms (*1)(*2):

If a flow rate becomes greater or smaller than the set value, this alarm is generated. In addition, two upper limits (H, HH) and two lower limits (L, LL) can be set. If a flow rate becomes greater or smaller than any of the set values, the status is output.

Electrode Adhesion Diagnostics Function (*1) (*2):

This function enables monitoring of the adhesion level of insulating substances to the electrodes. Depending on the status of adhesion, users are notified by a warning or an alarm via status outputs. If replaceable electrodes are used, they can be removed and cleaned when adhesion occurs.

● Flowtubes (Remote Flowtube/Integral Flowmeter)

Size of AXF Flowtubes: AXF Standard (Lay length code 1)

Unit: mm (in.)

Use	Process Connection	Lining	Remote Flowtube	Integral Flowmeter	High Grade Accuracy 0.2% of Rate (*3)	Enhanced Dual Frequency Excitation (Optional code HF1, HF2) (*3)	Replaceable Electrode (Electrode structure code 2)	
General-purpose Use	Wafer	PFA	2.5 (0.1), 5 (0.2), 10 (0.4), 15 (0.5), 25 (1.0), 32 (1.25), 40 (1.5), 50 (2.0), 65 (2.5), 80 (3.0), 100 (4.0), 125 (5.0), 150 (6.0), 200 (8.0), 250 (10), 300 (12)		25 (1.0), 32 (1.25), 40 (1.5), 50 (2.0), 65 (2.5), 80 (3.0), 100 (4.0), 125 (5.0), 150 (6.0), 200 (8.0)	25 (1.0), 32 (1.25), 40 (1.5), 50 (2.0), 65 (2.5), 80 (3.0), 100 (4.0), 125 (5.0), 150 (6.0), 200 (8.0)	25 (1.0), 32 (1.25), 40 (1.5), 50 (2.0), 65 (2.5), 80 (3.0), 100 (4.0), 125 (5.0), 150 (6.0), 200 (8.0), 250 (10), 300 (12)	
		Polyurethane Rubber	25 (1.0), 32 (1.25), 40 (1.5), 50 (2.0), 65 (2.5), 80 (3.0), 100 (4.0), 125 (5.0), 150 (6.0), 200 (8.0), 250 (10), 300 (12)		—	25 (1.0), 32 (1.25), 40 (1.5), 50 (2.0), 65 (2.5), 80 (3.0), 100 (4.0), 125 (5.0), 150 (6.0), 200 (8.0)	25 (1.0), 32 (1.25), 40 (1.5), 50 (2.0), 65 (2.5), 80 (3.0), 100 (4.0), 125 (5.0), 150 (6.0), 200 (8.0), 250 (10), 300 (12)	
		Natural Soft Rubber	50 (2.0), 65 (2.5), 80 (3.0), 100 (4.0), 125 (5.0), 150 (6.0), 200 (8.0), 250 (10), 300 (12)		—	50 (2.0), 65 (2.5), 80 (3.0), 100 (4.0), 125 (5.0), 150 (6.0), 200 (8.0)	—	
		EPDM Rubber	50 (2.0), 65 (2.5), 80 (3.0), 100 (4.0), 125 (5.0), 150 (6.0), 200 (8.0), 250 (10), 300 (12)		—	50 (2.0), 65 (2.5), 80 (3.0), 100 (4.0), 125 (5.0), 150 (6.0), 200 (8.0)	—	
		Ceramics (*1)	15 (0.5), 25 (1.0), 40 (1.5), 50 (2.0), 80 (3.0), 100 (4.0), 150 (6.0), 200 (8.0)		25 (1.0), 40 (1.5), 50 (2.0), 80 (3.0), 100 (4.0), 150 (6.0), 200 (8.0)	25 (1.0), 40 (1.5), 50 (2.0), 80 (3.0), 100 (4.0), 150 (6.0), 200 (8.0)	—	
	Flange	PFA	2.5 (0.1), 5 (0.2), 10 (0.4), 15 (0.5), 25 (1.0), 32 (1.25), 40 (1.5), 50 (2.0), 65 (2.5), 80 (3.0), 100 (4.0), 125 (5.0), 150 (6.0), 200 (8.0), 250 (10), 300 (12), 350 (14), 400 (16)		25 (1.0), 32 (1.25), 40 (1.5), 50 (2.0), 65 (2.5), 80 (3.0), 100 (4.0), 125 (5.0), 150 (6.0), 200 (8.0)	25 (1.0), 32 (1.25), 40 (1.5), 50 (2.0), 65 (2.5), 80 (3.0), 100 (4.0), 125 (5.0), 150 (6.0), 200 (8.0)	25 (1.0), 32 (1.25), 40 (1.5), 50 (2.0), 65 (2.5), 80 (3.0), 100 (4.0), 125 (5.0), 150 (6.0), 200 (8.0)	25 (1.0), 32 (1.25), 40 (1.5), 50 (2.0), 65 (2.5), 80 (3.0), 100 (4.0), 125 (5.0), 150 (6.0), 200 (8.0), 250 (10), 300 (12), 350 (14), 400 (16)
		Polyurethane Rubber	25 (1.0), 32 (1.25), 40 (1.5), 50 (2.0), 65 (2.5), 80 (3.0), 100 (4.0), 125 (5.0), 150 (6.0), 200 (8.0), 250 (10), 300 (12), 350 (14), 400 (16)	25 (1.0), 32 (1.25), 40 (1.5), 50 (2.0), 65 (2.5), 80 (3.0), 100 (4.0), 125 (5.0), 150 (6.0), 200 (8.0), 250 (10), 300 (12), 350 (14), 400 (16)	—	25 (1.0), 32 (1.25), 40 (1.5), 50 (2.0), 65 (2.5), 80 (3.0), 100 (4.0), 125 (5.0), 150 (6.0), 200 (8.0)	25 (1.0), 32 (1.25), 40 (1.5), 50 (2.0), 65 (2.5), 80 (3.0), 100 (4.0), 125 (5.0), 150 (6.0), 200 (8.0), 250 (10), 300 (12), 350 (14), 400 (16)	
		Natural Soft Rubber	50 (2.0), 65 (2.5), 80 (3.0), 100 (4.0), 125 (5.0), 150 (6.0), 200 (8.0), 250 (10), 300 (12), 350(14), 400(16)		—	50 (2.0), 65 (2.5), 80 (3.0), 100 (4.0), 125 (5.0), 150 (6.0), 200 (8.0)	—	
		EPDM Rubber	50 (2.0), 65 (2.5), 80 (3.0), 100 (4.0), 125 (5.0), 150 (6.0), 200 (8.0), 250 (10), 300 (12), 350(14), 400(16)		—	50 (2.0), 65 (2.5), 80 (3.0), 100 (4.0), 125 (5.0), 150 (6.0), 200 (8.0)	—	
	Union Joint	Ceramics (*2)	2.5 (0.1), 5 (0.2), 10 (0.4)		—	—	—	

Size of AXF Flowtubes: AXF Standard (Lay length code 1) (continued)

Unit: mm (in.)

Use	Process Connection	Lining	Remote Flowtube	Integral Flowmeter	High Grade Accuracy 0.2% of Rate (*3)	Enhanced Dual Frequency Excitation (Optional code HF1, HF2) (*3)	Replaceable Electrode (Electrode structure code 2)
Submersible Type	Wafer	PFA	15 (0.5), 25 (1.0), 32 (1.25), 40 (1.5), 50 (2.0), 65 (2.5), 80 (3.0), 100 (4.0), 125 (5.0), 150 (6.0), 200 (8.0), 250 (10), 300 (12)	—	25 (1.0), 32 (1.25), 40 (1.5), 50 (2.0), 65 (2.5), 80 (3.0), 100 (4.0), 125 (5.0), 150 (6.0), 200 (8.0)	25 (1.0), 32 (1.25), 40 (1.5), 50 (2.0), 65 (2.5), 80 (3.0), 100 (4.0), 125 (5.0), 150 (6.0), 200 (8.0)	—
		Polyurethane Rubber	25 (1.0), 32 (1.25), 40 (1.5), 50 (2.0), 65 (2.5), 80 (3.0), 100 (4.0), 125 (5.0), 150 (6.0), 200 (8.0), 250 (10), 300 (12)	—	—	25 (1.0), 32 (1.25), 40 (1.5), 50 (2.0), 65 (2.5), 80 (3.0), 100 (4.0), 125 (5.0), 150 (6.0), 200 (8.0)	—
		Natural Soft Rubber	50 (2.0), 65 (2.5), 80 (3.0), 100 (4.0), 125 (5.0), 150 (6.0), 200 (8.0), 250 (10), 300 (12)	—	—	50 (2.0), 65 (2.5), 80 (3.0), 100 (4.0), 125 (5.0), 150 (6.0), 200 (8.0)	—
		EPDM Rubber	50 (2.0), 65 (2.5), 80 (3.0), 100 (4.0), 125 (5.0), 150 (6.0), 200 (8.0), 250 (10), 300 (12)	—	—	50 (2.0), 65 (2.5), 80 (3.0), 100 (4.0), 125 (5.0), 150 (6.0), 200 (8.0)	—
	Flange	PFA	15 (0.5), 25 (1.0), 32 (1.25), 40 (1.5), 50 (2.0), 65 (2.5), 80 (3.0), 100 (4.0), 125 (5.0), 150 (6.0), 200 (8.0), 250 (10), 300 (12), 350 (14), 400 (16)	—	25 (1.0), 32 (1.25), 40 (1.5), 50 (2.0), 65 (2.5), 80 (3.0), 100 (4.0), 125 (5.0), 150 (6.0), 200 (8.0)	25 (1.0), 32 (1.25), 40 (1.5), 50 (2.0), 65 (2.5), 80 (3.0), 100 (4.0), 125 (5.0), 150 (6.0), 200 (8.0)	—
		Polyurethane Rubber	25 (1.0), 32 (1.25), 40 (1.5), 50 (2.0), 65 (2.5), 80 (3.0), 100 (4.0), 125 (5.0), 150 (6.0), 200 (8.0), 250 (10), 300 (12), 350 (14), 400 (16)	—	—	25 (1.0), 32 (1.25), 40 (1.5), 50 (2.0), 65 (2.5), 80 (3.0), 100 (4.0), 125 (5.0), 150 (6.0), 200 (8.0)	—
		Natural Soft Rubber	50 (2.0), 65 (2.5), 80 (3.0), 100 (4.0), 125 (5.0), 150 (6.0), 200 (8.0), 250 (10), 300 (12), 350 (14), 400 (16)	—	—	50 (2.0), 65 (2.5), 80 (3.0), 100 (4.0), 125 (5.0), 150 (6.0), 200 (8.0)	—
		EPDM Rubber	50 (2.0), 65 (2.5), 80 (3.0), 100 (4.0), 125 (5.0), 150 (6.0), 200 (8.0), 250 (10), 300 (12), 350 (14), 400 (16)	—	—	50 (2.0), 65 (2.5), 80 (3.0), 100 (4.0), 125 (5.0), 150 (6.0), 200 (8.0)	—
Explosion proof Type	Wafer	PFA	2.5 (0.1), 5 (0.2), 10 (0.4), 15 (0.5), 25 (1.0), 32 (1.25), 40 (1.5), 50 (2.0), 65 (2.5), 80 (3.0), 100 (4.0), 125 (5.0), 150 (6.0), 200 (8.0), 250 (10), 300 (12)	—	25 (1.0), 32 (1.25), 40 (1.5), 50 (2.0), 65 (2.5), 80 (3.0), 100 (4.0), 125 (5.0), 150 (6.0), 200 (8.0)	25 (1.0), 32 (1.25), 40 (1.5), 50 (2.0), 65 (2.5), 80 (3.0), 100 (4.0), 125 (5.0), 150 (6.0), 200 (8.0)	—
		Ceramics (*1)	15 (0.5), 25 (1.0), 40 (1.5), 50 (2.0), 80 (3.0), 100 (4.0), 150 (6.0), 200 (8.0)	—	25 (1.0), 40 (1.5), 50 (2.0), 80 (3.0), 100 (4.0), 150 (6.0), 200 (8.0)	25 (1.0), 40 (1.5), 50 (2.0), 80 (3.0), 100 (4.0), 150 (6.0), 200 (8.0)	—
	Flange	PFA	2.5 (0.1), 5 (0.2), 10 (0.4), 15 (0.5), 25 (1.0), 32 (1.25), 40 (1.5), 50 (2.0), 65 (2.5), 80 (3.0), 100 (4.0), 125 (5.0), 150 (6.0), 200 (8.0), 250 (10), 300 (12), 350 (14), 400 (16)	—	25 (1.0), 32 (1.25), 40 (1.5), 50 (2.0), 65 (2.5), 80 (3.0), 100 (4.0), 125 (5.0), 150 (6.0), 200 (8.0)	25 (1.0), 32 (1.25), 40 (1.5), 50 (2.0), 65 (2.5), 80 (3.0), 100 (4.0), 125 (5.0), 150 (6.0), 200 (8.0)	—
	Union Joint	Ceramics (*2)	2.5 (0.1), 5 (0.2), 10 (0.4)	—	—	—	—
Sanitary Type	Clamp: Tri-Clamp (*4), DIN32676 ISO2852/SMS3016 Union: DIN11851 ISO2853 (*5) SMS1145 (*6) Butt Weld: DIN11850, ISO203	PFA	15 (0.5), 25 (1.0), 32 (1.25), 40 (1.5), 50 (2.0), 65 (2.5), 80 (3.0), 100 (4.0), 125 (5.0)	—	25 (1.0), 32 (1.25), 40 (1.5), 50 (2.0), 65 (2.5), 80 (3.0), 100 (4.0), 125 (5.0)	25 (1.0), 32 (1.25), 40 (1.5), 50 (2.0), 65 (2.5), 80 (3.0), 100 (4.0), 125 (5.0)	—

*1: AXF standard lay length dimensions for wafer type ceramics linings are the same as those for ADMAG ceramics linings.

*2: AXF standard lay length dimensions for union joint type ceramics linings are the same as those for ADMAG ceramics linings.

*3: Enhanced dual frequency excitation is not available for models with High grade accuracy.

*4: Not available with 32 mm (1.25 in.), 125 mm (5.0 in.)

*5: Not available with 125 mm (5.0 in.)

*6: Not available with 15 mm (0.5 in.), 125 mm (5.0 in.)

T21.EPS

Size of AXF Flowtubes: Replacement model for earlier ADMAG or ADMAG AE (Lay length code 2)

Unit: mm (in.)

Use	Process Connection	Lining	Remote Flowtube	Integral Flowmeter	High Grade Accuracy 0.2% of Rate	Enhanced Dual Frequency Excitation (Optional code HF1,HF2)	Replaceable Electrode (Electrode structure code 2)
General-purpose use	Wafer (*6)	PFA	2.5 (0.1), 5 (0.2), 10 (0.4), 15 (0.5), 25 (1.0), 40 (1.5), 50 (2.0), 80 (3.0), 100 (4.0), 150 (6.0), 200 (8.0)		—	25 (1.0), 40 (1.5), 50 (2.0), 80 (3.0), 100 (4.0), 150 (6.0), 200 (8.0)	—
		Polyurethane rubber	25 (1.0), 40 (1.5), 50 (2.0), 80 (3.0), 100(4.0), 150 (6.0), 200(8.0)		—	25 (1.0), 40(1.5), 50 (2.0), 80(3.0), 100 (4.0), 150 (6.0), 200 (8.0)	—
	Flange (*7)	PFA	150 (6.0), 200 (8.0), 250 (10)		—	150 (6.0), 200 (8.0)	150 (6.0), 200 (8.0), 250 (10)
		Polyurethane rubber	150 (6.0), 200 (8.0), 250 (10)		—	150 (6.0), 200 (8.0)	150 (6.0), 200 (8.0), 250 (10)
Submersible Type	Wafer (*6)	PFA	15 (0.5), 25 (1.0), 40 (1.5), 50 (2.0), 80 (3.0), 100 (4.0), 150 (6.0), 200 (8.0)	—	—	25 (1.0), 40 (1.5), 50 (2.0), 80 (3.0), 100 (4.0), 150 (6.0), 200 (8.0)	—
		Polyurethane rubber	25 (1.0), 40 (1.5), 50 (2.0), 80 (3.0), 100 (4.0), 150 (6.0), 200 (8.0)	—	—	25 (1.0), 40 (1.5), 50 (2.0), 80 (3.0), 100 (4.0), 150 (6.0), 200 (8.0)	—
	Flange (*7)	PFA	150 (6.0), 200 (8.0), 250(10)	—	—	150 (6.0), 200 (8.0)	—
		Polyurethane rubber	150 (6.0), 200 (8.0), 250 (10)	—	—	150 (6.0), 200 (8.0)	—
Explosion proof Type	Wafer (*6)	PFA	2.5 (0.1), 5 (0.2), 10 (0.4), 15 (0.5), 25 (1.0), 40 (1.5), 50 (2.0), 80 (3.0), 100 (4.0), 150 (6.0), 200 (8.0)		—	25 (1.0), 40 (1.5), 50 (2.0), 80 (3.0), 100 (4.0), 150 (6.0), 200 (8.0)	—
	Flange (*7)	PFA	150 (6.0), 200 (8.0), 250 (10)		—	150 (6.0), 200 (8.0)	—

*6: ADMAG lay length dimensions for wafer type of 250 mm (10 in.), and 300 mm (12 in.) are the same as those for AXF Standard. And, in case of "platinum-iridium (grounding ring code P) or tantalum (grounding ring code T) or None (grounding ring code N)" in wafer type of 2.5 mm (0.1 in.) to 15 mm (0.5 in.), the lay lengths of Replacement model are the same as those for AXF Standard.
 *7: ADMAG lay length dimensions for flange type of 15 mm (0.5 in.) to 100 mm (4.0 in.), or 300 mm (12 in.) to 400 mm (16 in.) are the same as those for AXF Standard. However, in case of platinum-iridium (grounding ring code P) or tantalum (grounding ring code T) or None (grounding ring code N) in flange type of 15 mm (0.5 in.) to 100 mm (4.0 in.), the lay length of AXF Standard are longer by approx. 4mm (0.16 in) than those of earlier ADMAG or ADMAG AE.

Protection:

General-Purpose Use/Sanitary Type/TIIS Flameproof

Type:

IP66, IP67

Explosion proof type except TIIS:

In case of explosion proof type except TIIS, refer to description of "Enclosure" in "HAZARDOUS AREA CLASSIFICATION".

Submersible Type (only for Remote Flowtube):

IP68 (Conforms to continuous immersion under the following test condition)

Test Condition:

50 m below the surface of the water, equivalent to 0.5 MPa hydraulic pressure, for one month.
 Cable should be protected at customer site.

Coating:

General-Purpose Use/Explosion proof Type:

Size 2.5 to 125 mm (0.1 to 5.0 in.) (Wafer type),
 Size 2.5 to 125 mm (0.1 to 5.0 in.) (Process connection code B or D of flange type):

- Housing: No coating (Stainless steel surface)
- Flange (Flange type only) : No coating (Stainless steel surface)
- Terminal Box and Cover (Remote Flowtube):

Corrosion-resistant coating
 Coating color; Mint green (Munsell 5.6 BG 3.3/2.9 or its equivalent)

Size 150 to 300 mm (6.0 to 12 in.) (Wafer type),
 Size 150 to 400 mm (6.0 to 16 in.) (Process connection code B of flange type),
 Size 50 to 400 mm (2.0 to 16 in.) (Process connection code C of flange type):

- Housing, Flange (Flange type only), Terminal Box and Cover (Remote Flowtube):

Corrosion-resistant coating
 Coating color; Mint green (Munsell 5.6 BG 3.3/2.9 or its equivalent)

Sanitary Type:

Size 15 to 125 mm (0.5 to 5.0 in.):

- Housing: No coating (Stainless steel surface)
- Adapter : No coating (Stainless steel surface)
- Terminal Box and Cover (Remote Flowtube):

Corrosion-resistant coating
 Coating color; Mint green (Munsell 5.6 BG 3.3/2.9 or its equivalent)

Submersible Type: Non-tar epoxy coating (black)

Flowtube Material:

Size 2.5 mm (0.1 in.) to 15 mm (0.5 in.)

Part Name		Material
Housing		Stainless steel-JIS SCS11 equivalent
Flange		Stainless steel-JIS SUS304 or SUSF304 (AISI 304 SS/EN 1.4301 equivalent)
Mini-Flange	Wafer Type PFA/Polyurethane Rubber lining	Stainless steel-JIS SCS13 (EN 1.4308 equivalent)
	Wafer Type Ceramics lining [only for 15 mm (0.5 in.)]	Stainless steel-JIS SUS316L (AISI 316 SS/EN 1.4404 equivalent)
	Sanitary Type [only for 15 mm (0.5 in.)]	Stainless steel-JIS SCS13 (EN 1.4308 equivalent)
Pipe	Wafer Type PFA/Polyurethane Rubber lining	Stainless steel-JIS SCS13 (EN 1.4308 equivalent)
	Wafer Type/Union Joint Ceramics lining	Alumina ceramics (99.9%)
	Flange Type PFA lining	Stainless steel-JIS SCS13 (EN 1.4308 equivalent) and SUS304 (AISI 304 SS/EN 1.4301 equivalent)
	Sanitary Type [only for 15 mm (0.5 in.)]	Stainless steel-JIS SCS13 (EN 1.4308 equivalent)
Terminal Box (Remote Flowtube)		Aluminum alloy

T03.EPS

Size 25 mm (1.0 in.) to 125 mm (5.0 in.)

Part Name		Material		
Housing		Stainless steel-JIS SUS304 (AISI 304 SS/EN 1.4301 equivalent)		
Flange	Process Connection code: B**	Stainless steel-JIS SUS304 or SUSF304 (AISI 304 SS/EN 1.4301 equivalent)		
	Process Connection code: C** [(Size 50 mm (2.0 in.) to 125 mm (5.0 in.))]	Carbon steel-JIS SS400 or SFVC 2A		
Mini-Flange	Wafer Type PFA/Polyurethane Rubber/ Natural Soft Rubber/ EPDM Rubber lining	Size 25 mm (1.0 in.) (Lay Length code 1)	Stainless steel- EN 1.4308 (SCS13 equivalent)	
		Size 25 mm (1.0 in.) (Lay Length code 2)	Stainless steel-JIS SUS430 (ASTM 43000/DIN X6Cr17/EN 1.4016 equivalent)	
		Size 32 mm (1.25 in.) to 125 mm (5.0 in.)	Stainless steel-JIS SUS430 (ASTM 43000/DIN X6Cr17/EN 1.4016 equivalent)	
	Wafer Type Ceramics lining	Size 25 mm (1.0 in.) to 50 mm (2.0 in.)	Stainless steel-JIS SUS316L (AISI 316L SS/EN 1.4404 equivalent)	
		Size 80 mm (3.0 in.), 100 mm (4.0 in.)	Stainless steel-JIS SUS304 (AISI 304 SS/EN 1.4301 equivalent)	
	Sanitary Type	Size 25 mm (1.0 in.)	Stainless steel-JIS SCS13 (EN 1.4308 equivalent)	
		Size 32 mm (1.25 in.) to 125 mm (5.0 in.)	Stainless steel-JIS SUS304 (AISI 304 SS/EN 1.4301 equivalent)	
	Pipe	Wafer Type PFA/Polyurethane Rubber/ Natural Soft Rubber/ EPDM Rubber lining	Size 25 mm (1.0 in.) (Lay Length code 1)	Stainless steel- EN 1.4308 (SCS13 equivalent)
			Size 25 mm (1.0 in.) (Lay Length code 2)	Stainless steel-JIS SUS304 (AISI 304 SS/EN 1.4301 equivalent)
			Size 32 mm (1.25 in.) to 125 mm (5.0 in.)	Stainless steel-JIS SUS304 (AISI 304 SS/EN 1.4301 equivalent)
Flange Type PFA/Polyurethane Rubber/ Natural Soft Rubber/ EPDM Rubber lining		Size 25 mm (1.0 in.)	Stainless steel- EN 1.4308 (SCS13 equivalent)	
		Size 32 mm (1.25 in.) to 125 mm (5.0 in.)	Stainless steel-JIS SUS304 (AISI 304 SS/EN 1.4301 equivalent)	
Wafer Type Ceramics lining		Size 25 mm (1.0 in.) to 100 mm (4.0 in.)	Alumina ceramics (99.9%)	
Sanitary Type		Size 25 mm (1.0 in.)	Stainless steel-JIS SCS13 (EN 1.4308 equivalent)	
		Size 32 mm (1.25 in.) to 125 mm (5.0 in.)	Stainless steel-JIS SUS304 (AISI 304 SS/EN 1.4301 equivalent)	
Terminal Box (Remote Flowtube)		Aluminum alloy		

T04.EPS

Size 150 mm (6.0 in.) to 400 mm (16 in.)

Part Name		Material
Housing		Carbon steel-JIS SPCC equivalent
Flange	Process Connection code: B**	Stainless steel-JIS SUS304 or SUSF304 (AISI 304 SS/EN 1.4301 equivalent)
	Process Connection code: C**	Carbon steel-JIS SS400 or SFVC 2A
Mini-Flange	Wafer Type PFA/Polyurethane Rubber/Natural Soft Rubber/EPDM Rubber lining	Carbon steel-JIS SS400 or SFVC 2A
	Wafer Type Ceramics lining [available with 150 mm (6.0 in.), 200 mm (8.0 in.)]	Stainless steel-JIS SUS304 (AISI 304 SS/EN 1.4301 equivalent)
Pipe	Flange Type/Wafer Type PFA/Polyurethane Rubber/Natural Soft Rubber/EPDM Rubber lining	Stainless steel-JIS SUS304 (AISI 304 SS/EN 1.4301 equivalent)
	Wafer Type Ceramics lining [available with 150 mm (6.0 in.), 200 mm (8.0 in.)]	Alumina ceramics (99.9%)
Terminal Box (Remote Flowtube)		Aluminum alloy

T05.EPS

Wetted Part Material:

Lining:

- Fluorocarbon PFA*1 lining
- Polyurethane Rubber lining
- Natural Soft Rubber lining*2
- EPDM Rubber lining*3
- Alumina ceramics lining

- *1: PFA is FDA (U.S. Food and Drug Administration) approval material.
- *2: Natural soft rubber is a material which can reduce wear of the lining due to fluids mixed with slurries. If the concentration of mixed slurries is high, contact Yokogawa as necessary measures need to be taken separately for the electrodes.
- *3: EPDM rubber lining is superior in the ozone proof.

Electrode:

Stainless steel-JIS SUS316L (AISI 316L SS/EN 1.4404 equivalent), Hastelloy*1 C276 equivalent, Titanium, Tantalum, Platinum-Iridium, Tungsten Carbide, Platinum-Alumina cermet(only for ceramics lining)
 Note : For sanitary type, SUS316L only.

Grounding Ring/Grounding Electrode:

- Grounding Ring(plate type)
 Stainless steel-JIS SUS316 (AISI 316 SS/EN 1.4401 equivalent),
 Stainless steel-JIS SUS316L (AISI 316L SS/EN 1.4404 equivalent),
 Hastelloy*1 C276 equivalent, Titanium
 - Grounding Electrode(electrode type)
 Fluorocarbon PFA lining + grounding electrode (Tantalum, Platinum-Iridium)
- *1: Hastelloy is a registered trademark of Haynes International Inc.
 *2: Available with sizes 2.5 to 200mm (0.1 to 8.0 in.), PFA and ceramics linings only. However, the permeable fluids (such as nitric acid, hydrofluoric acid, or sodium hydroxide at high temperature) are unusable.

Gasket:

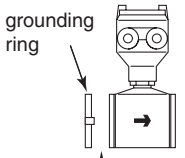
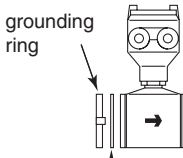
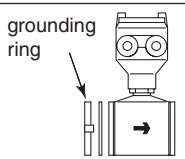
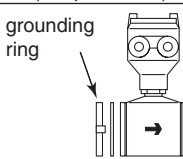
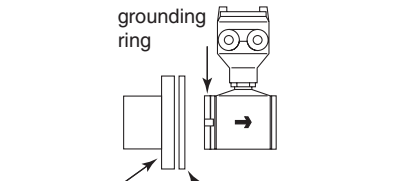
Use	General-Purpose Use / Submersible Type / Explosion proof Type	
Lining	PFA/Polyurethane Rubber/ Natural Soft Rubber/ EPDM Rubber	Ceramics
Standard	 No gasket within Flowtube	 Gasket within Flowtube
	Gasket Material (within Flowtube)	
	—	Fluororesin with ceramic fillers (Valqua #7020)
Optional code (GA, GC, GD, or GF)	 Gasket within Flowtube	 Gasket within Flowtube
	Gasket Material (within Flowtube)	
	GA: Fluororubber for PVC pipes (Viton®) GC: Acid-resistant fluororubber for PVC pipes (Viton®) GD: Alkali-resistant fluororubber for PVC pipes (Viton®) GF*1: Fluororesin with alkali-resistant carbons for metal pipes *1: GF is applicable only for ceramics lining.	
Optional code (BCF, BSF, BCC, or BSC)	 Flange of user's pipe Gasket for user's flange	
	Gasket Material (for user's flange)	
	BCF, BSF: PTFE-sheathed non-asbestos BCC, BSC: Chloroprene rubber	

T23-1.EPS

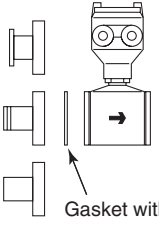
Use	Sanitary Type
Lining	PFA
Standard	 Adapter for clamp connection Adapter for union connection Adapter for butt weld connection Gasket within Flowtube
	Gasket Material (within Flowtube)
	EPDM (ethylene propylene) rubber
Optional code (GH)	GH: Silicone rubber

T23-2.EPS

Joints:

Lining	Ceramics Union Joints (size 10 mm or less)	
Standard	<p>weld joint (GUW)</p> <p>screw joint (GUN, GUR)</p> <p>nut</p> <p>Gasket within Flowtube</p>	
	Materials for Union Joint	
	Process Connection Code GUW: Union Joint (weld joint)	Stainless steel (JIS SUS316L (ANSI 316L SS/EN 1.4404 equivalent))
Process Connection Code GUN, GUR: union joint (screw joint)		

Note: Contact Yokogawa office if PVC union joint is required.

T23-3.EPS

Use	Sanitary Type
Standard	<p>Adapter for clamp connection</p> <p>Adapter for union connection</p> <p>Adapter for butt weld connection</p>
	Materials for Adapters (clamp, union, butt weld)
	Stainless steel-JIS SUS316L or SUSF316L (AISI 316L SS/EN 1.4404 equivalent or ANSI F316L SS/EN 1.4435 equivalent)

T23-4.EPS

O-Ring (Replaceable electrode type only):

Fluororubber (Part number : G9303SE)

Recommended Gaskets Between Flowtubes

And Unser's Flanges:

Gaskets Type

Use compressed non-asbestos fiber gaskets, PTFE-sheathed non-asbestos gaskets or gaskets which have equivalent elasticity.

For optional codes GA, GC, and GD, use rubber gaskets or others which have equivalent elasticity (such as Teflon-coated rubber gaskets).

Inner Diameter of Grounding Ring, Outer Diameter for Effective Sealing, Recommended Inner Diameter of Gasket;
 Be sure to choose a gasket with an inner and outer diameter that does not protrude inside the piping.

If the inner diameter of the gasket is too large, or outer diameter of the gasket is too small, fluid leakage may result.

AXF Standard:

Unit : mm (in.)

Size	PFA/ Polyurethane Rubber/ Natural Soft Rubber/ EPDM Rubber								Ceramics			
	Water				Flange				Inner Diameter of Grounding Ring [øA]	Outer Diameter for Effective Sealing [øB]	Recommended Inner Diameter of Gasket	
	Inner Diameter of Grounding Ring [øA]	Outer Diameter for Effective Sealing [øB]	Recommended Inner Diameter of Gasket		Inner Diameter of Grounding Ring [øA]	Outer Diameter for Effective Sealing [øB]	Recommended Inner Diameter of Gasket				Flat Gasket [øC]	PTFE-sheathed Non-asbestos Gasket [øD]
			Flat Gasket [øC]	PTFE-sheathed Non-asbestos Gasket [øD]			Flat Gasket [øC]	PTFE-sheathed Non-asbestos Gasket [øD]				
2.5 (0.1)	15 (0.59)	38 (1.50)	17 (0.67)	22 (0.87)	15 (0.59) [12 (0.47)] *1	30 (1.18)	17 (0.67) [15 (0.59)]*1	22 (0.87) [19 (0.75)]*1	-	-	-	
5 (0.2)	15 (0.59)	38 (1.50)	17 (0.67)	22 (0.87)	15 (0.59) [12 (0.47)] *1	30 (1.18)	17 (0.67) [15 (0.59)]*1	22 (0.87) [19 (0.75)]*1	-	-	-	
10 (0.4)	15 (0.59)	38 (1.50)	17 (0.67)	22 (0.87)	15 (0.59) [12 (0.47)] *1	30 (1.18)	17 (0.67) [15 (0.59)]*1	22 (0.87) [19 (0.75)]*1	-	-	-	
15 (0.5)	15 (0.59)	38 (1.50)		22 (0.87)	15 (0.59)	34 (1.34)		22 (0.87)	15 (0.59)	33 (1.30)	22 (0.87)	
25 (1.0)	28 (1.10)	53 (2.09)		35 (1.38)	28 (1.10)	53 (2.09)		35 (1.38)	27 (1.06)	50 (1.97)	35 (1.38)	
32 (1.25)	34 (1.34)	58 (2.28)		43 (1.69)	34 (1.34)	58 (2.28)		43 (1.69)	-	-	-	
40 (1.5)	41 (1.61)	71 (2.80)		49 (1.93)	41 (1.61)	71 (2.80)		49 (1.93)	40 (1.57)	68 (2.68)	49 (1.93)	
50 (2.0)	53 (2.09)	84 (3.31)		61 (2.40)	53 (2.09)	84 (3.31)		61 (2.40)	52 (2.05)	82 (3.23)	61 (2.40)	
65 (2.5)	66 (2.60)	103 (4.06)		84 (3.31)	66 (2.60)	103 (4.06)		84 (3.31)	-	-	-	
80 (3.0)	77 (3.03)	114 (4.49)		90 (3.54)	77 (3.03)	114 (4.49)		90 (3.54)	81 (3.19)	112 (4.41)	90 (3.54)	
100 (4.0)	102 (4.02)	140 (5.51)		115 (4.53)	102 (4.02)	140 (5.51)		115 (4.53)	98 (3.86)	134 (5.28)	115 (4.53)	
125 (5.0)	128 (5.04)	165 (6.50)		141 (5.55)	128 (5.04)	165 (6.50)		141 (5.55)	-	-	-	
150 (6.0)	146.1 (5.75)	190 (7.48)		167 (6.57)	146.1 (5.75)	190 (7.48)		167 (6.57)	144 (5.67)	188 (7.40)	167 (6.57)	
200 (8.0)	193.6 (7.62)	240 (9.45)		218 (8.58)	193.6 (7.62)	240 (9.45)		218 (8.58)	192 (7.56)	240 (9.45)	218 (8.58)	
250 (10)	243.7 (9.59)	300 (11.81)		270 (10.63)	243 (9.57)	315 (12.40)		270 (10.63)	-	-	-	
300 (12)	294.7 (11.60)	348 (13.70)		321 (12.64)	291.3 (11.47)	360 (14.17)		321 (12.64)	-	-	-	
350 (14)	-	-		-	323.4 (12.73)	405 (15.94)		359 (14.13)	-	-	-	
400 (16)	-	-		-	373.5 (14.70)	465 (18.31)		410 (16.14)	-	-	-	

*1: The inner diameter of the process connection code: DD4, DJ, DJ2 is values in brackets [].

T25.EPS

Replacement Model for earlier ADMAG or ADMAG AE:

Unit : mm (in.)

Size	PFA/ Polyurethane Rubber							
	Water				Flange			
	Inner Diameter of Grounding Ring [øA]	Outer Diameter for Effective Sealing [øB]	Recommended Inner Diameter of Gasket		Inner Diameter of Grounding Ring [øA]	Outer Diameter for Effective Sealing [øB]	Recommended Inner Diameter of Gasket	
			Flat Gasket [øC]	PTFE-sheathed Non-asbestos Gasket [øD]			Flat Gasket [øC]	PTFE-sheathed Non-asbestos Gasket [øD]
2.5 (0.1)	15 (0.59)	38 (1.50)	17 (0.67)	22 (0.87)	-	-	-	-
5 (0.2)	15 (0.59)	38 (1.50)	17 (0.67)	22 (0.87)	-	-	-	-
10 (0.4)	15 (0.59)	38 (1.50)	17 (0.67)	22 (0.87)	-	-	-	-
15 (0.5)	15 (0.59)	38 (1.50)		22 (0.87)	-	-	-	-
25 (1.0)	27 (1.06)	56 (2.20)		35 (1.38)	-	-	-	-
40 (1.5)	40 (1.57)	71 (2.80)		49 (1.93)	-	-	-	-
50 (2.0)	52 (2.05)	85 (3.35)		61 (2.40)	-	-	-	-
80 (3.0)	81 (3.19)	115 (4.53)		90 (3.54)	-	-	-	-
100 (4.0)	98 (3.86)	144 (5.67)		115 (4.53)	-	-	-	-
150 (6.0)	140.7 (5.54)	190 (7.48)		167 (6.57)	140.7 (5.54)	205 (8.07)		167 (6.57)
200 (8.0)	188.9 (7.44)	240 (9.45)		218 (8.58)	188.9 (7.44)	255 (10.04)		218 (8.58)
250 (10)	-	-		-	243 (9.57)	315 (12.40)		270 (10.63)

Size of Inner Diameter of Grounding Ring, Outer Diameter for Effective Sealing and Recommended Inner Diameter of Gasket:

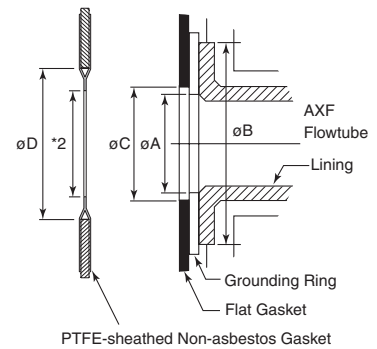

*2: Do not have this length be smaller than the inner diameter of grounding ring (øA).

T16-3.EPS

Electrode Construction:

Non-replaceable Electrode Type

General-Purpose Use/Submersible Type/Explosion proof Type:

PFA, Polyurethane Rubber lining:

External insertion type

Natural Soft Rubber, EPDM Rubber lining:

Internal insertion type

Ceramics lining: Integral type

Sanitary Type: Internal insertion type

Replaceable Electrode Type

Electrode parts can be put into unit to facilitate replacement or mounting at customer site.

The optional dedicated tool (F9807SK) is required.

Replaceable electrodes are available for the following:

AXF standard:

Use	Process Connection	Available Size	Lining	Electrode Material
General-Purpose Use	Wafer	25 to 300 mm (1.0 to 12 in.)	PFA/ Polyurethane Rubber	JIS SUS316L (AISI 316L SS/EN 1.4404 equivalent) ^(*)
	Flange	25 to 400 mm (1.0 to 16 in.)		

T06.EPS

Replacement model for earlier ADMAG or ADMAG AE:

Use	Process Connection	Available Size	Lining	Electrode Material
General-Purpose Use	Flange	150 to 250 mm (6.0 to 10 in.)	PFA/ Polyurethane Rubber	JIS SUS316L (AISI 316L SS/EN 1.4404 equivalent) ^(*)

T07.EPS

*1: If any other electrode materials are required, please contact Yokogawa office.

Mounting/Shapes (Remote Flowtube):

- Electrical Connection: ANSI 1/2 NPT female
ISO M20 × 1.5 female
JIS G1/2 female
- Direction of Electrical Connection: The direction can be changed even after delivery.
Note: In case of submersible types or an optional code DHC, the direction can not be changed after delivery.
- Terminal Connection at Terminal Box: M4 size screw

Grounding:

Grounding resistance 100 Ω or less

- * In case of explosion proof type except TIIS, follow the domestic electrical requirements as regulated in each country.
- * In case of TIIS Flameproof type, refer to description of "HAZARDOUS AREA CLASSIFICATION".

Combined Converter:

- A remote flowtube can be combined with the AXFA11 Converter or the AXFA14 Converter. If a combined converter is changed from AXFA11 to AXFA14 or vice versa, a new meter factor must be adjusted by flow calibrations.
- In case that size 250 mm (10 in.) or larger is used in low conductivity or high concentration slurries, please use the AXFA11 Converter.
- Maximum Cable Length:
Combination of AXF remote Flowtube and AXFA11: up to 200 m (660 ft)
Combination of AXF remote Flowtube and AXFA14: up to 100 m (330 ft)

HAZARDOUS AREA CLASSIFICATION

FM:

*AXF002C – AXF400C

Applicable Standard:
FM3600, FM3610, FM3615,
FM3810, ANSI/NEMA 250

(Integral Flowmeter)

Explosion proof for Class I, Division 1, Groups A, B, C & D.
Dust-ignition proof for Class II/III, Division1, Groups E, F & G.

Intrinsically safe (electrodes) for Class I, Division 1, Groups A, B, C & D.

“SEAL ALL CONDUITS WITHIN 18 INCHES”
“WHEN INSTALLED IN DIV. 2, SEALS NOT REQUIRED”

Electrode Circuit Um: 250 Vac/dc
Maximum power supply voltage: 250 Vac/130 Vdc
Excitation Circuit: 140V max
Enclosure: NEMA 4X
Temperature Code: T6

Note: Temperature Code T5 to T3 included in the scope of application and its approval.

Refer to following table;

Temperature Code	Maximum Process Temperature	Minimum Process Temperature
T6	+70°C (+158°F)	-40°C (-40°F)
T5	+85°C (+185°F)	-40°C (-40°F)
T4	+120°C (+248°F)	-40°C (-40°F)
T3	+130°C (+266°F)	-40°C (-40°F)

T27-1_1.EPS

Ambient Temp.: -40°C to +60°C (-40°F to +140°F)

(Remote Flowtube)

Explosion proof for Class I, Division 1, Groups A, B, C & D.
Dust-ignition proof for Class II/III, Division1, Groups E, F & G.

Intrinsically safe (electrodes) for Class I, Division 1, Groups A, B, C & D.

“SEAL ALL CONDUITS WITHIN 18 INCHES”
“WHEN INSTALLED IN DIV. 2, SEALS NOT REQUIRED”

Electrode Circuit Um: 250 Vac/dc
Excitation Circuit: 170V max
Enclosure: NEMA 4X
Temperature Code: T6

Note: Temperature Code T5 to T3 included in the scope of application and its approval.

Refer to following table;

Temperature Code	Maximum Process Temperature	Minimum Process Temperature
T6	+70°C (+158°F)	-40°C (-40°F)
T5	+85°C (+185°F)	-40°C (-40°F)
T4	+120°C (+248°F)	-40°C (-40°F)
T3	+150°C (+302°F)	-40°C (-40°F)

T28-1_1.EPS

Ambient Temp.: -40°C to +60°C (-40°F to +140°F)

Note: Installation shall be in accordance with the manufacturer's instructions and National Electric Code, ANSI/NFPA-70, and Local Electric Code.

Note: In case the electrodes and/or grounding rings are made of titanium, the flowtube should be kept away from impacts and frictions in hazardous locations.

ATEX:

*AXF002C – AXF400C

Applicable Standard:
EN 50014, EN 50018, EN 50019,
EN 50020, EN 50028, EN 50281-1-1
Certificate: KEMA 03ATEX2435

(Integral Flowmeter)

ATEX Flameproof Type

Group: II
Category: 2G
EEx dme[ia] IIC T6...T3
Electrode Circuit Um: 250 Vac/dc
Maximum power supply voltage: 250 Vac/130 Vdc
Excitation Circuit: 140V max
Enclosure: IP66, IP67
Temperature Class:

Temperature Class	Maximum Process Temperature	Minimum Process Temperature
T6	+70°C (+158°F)	-40°C (-40°F)
T5	+85°C (+185°F)	-40°C (-40°F)
T4	+120°C (+248°F)	-40°C (-40°F)
T3	+130°C (+266°F)	-40°C (-40°F)

T27-2.EPS

Ambient Temp.: -40°C to +60°C (-40°F to +140°F)

ATEX Type of Protection “Dust”

Group: II
Category: 1D
Electrode Circuit Um: 250 Vac/dc
Maximum power supply voltage: 250 Vac/130 Vdc
Excitation Circuit: 140V max
Enclosure: IP66, IP67
Maximum surface temperature:

Maximum Surface Temperature	Maximum Process Temperature
T75°C (+167°F)	+70°C (+158°F)
T85°C (+185°F)	+85°C (+185°F)
T100°C (+212°F)	+120°C (+248°F)
T110°C (+230°F)	+130°C (+266°F)

T29.EPS

Ambient Temp.: -40°C to +60°C (-40°F to +140°F)

**(Remote Flowtube)
ATEX Flameproof Type**

Group: II
 Category: 2G
 EEx dme[ia] IIC T6...T3
 Electrode Circuit Um: 250 Vac/dc
 Excitation Circuit: 170V max
 Enclosure: IP66, IP67
 Temperature Class:

Temperature Class	Maximum Process Temperature	Minimum Process Temperature
T6	+70°C (+158°F)	-40°C (-40°F)
T5	+85°C (+185°F)	-40°C (-40°F)
T4	+120°C (+248°F)	-40°C (-40°F)
T3	+150°C (+302°F)	-40°C (-40°F)

T28-2.EPS

Ambient Temp.: -40°C to +60°C (-40°F to +140°F)

ATEX Type of Protection “Dust”

Group: II
 Category: 1D
 Electrode Circuit Um: 250 Vac/dc
 Excitation Circuit: 170V max
 Enclosure: IP66, IP67
 Maximum surface temperature:

Maximum Surface Temperature	Maximum Process Temperature
T75°C (+167°F)	+70°C (+158°F)
T85°C (+185°F)	+85°C (+185°F)
T100°C (+212°F)	+120°C (+248°F)
T115°C (+239°F)	+150°C (+302°F)

T30.EPS

Ambient Temp.: -40°C to +60°C (-40°F to +140°F)

CSA:

*AXF002C – AXF400C
 Applicable Standard:
 For CSA C22.2 Series;
 C22.2 No 0, C22.2 No 0.4, C22.2 No 0.5,
 C22.2 No 25, C22.2 No 30, C22.2 No 94,
 C22.2 No 157, C22.2 No.61010-1-12,
 C22.2 No.61010-2-030-12
 For CSA E79 Series;
 CAN/CSA-E79-0, CAN/CSA-E79-1,
 CAN/CSA-E79-7, CAN/CSA-E79-11,
 CAN/CSA-E79-18
 Certificate: 1481213
 Process Sealing Certification:
 Dual Seal certified by CSA to the requirements of
 ANSI/ISA 12.27.01.
 No additional sealing required.
 Primary seal failure annunciation;
 Deterioration of the flowrate output at nonzero flow
 point.
 Unstable flowrate output at zero flow point.

(Integral Flowmeter)

For CSA C22. 2 Series

Explosion proof for Class I, Division 1, Groups A, B, C & D.
 Dust-ignition proof for Class II/III, Division 1, Groups E, F & G.
 Intrinsically safe (electrodes) for Class I, Division 1, Groups A, B, C & D.
 “SEAL ALL CONDUITS WITHIN 50 cm OF THE ENCLOSURE”
 “WHEN INSTALLED IN DIV. 2, SEALS NOT REQUIRED”

Electrode Circuit Um: 250 Vac/dc
 Maximum power supply voltage: 250 Vac/130 Vdc
 Excitation Circuit: 140V max
 Enclosure: Type 4X
 Temperature Code:

Temperature Code	Maximum Process Temperature	Minimum Process Temperature
T6	+70°C (+158°F)	-40°C (-40°F)
T5	+85°C (+185°F)	-40°C (-40°F)
T4	+120°C (+248°F)	-40°C (-40°F)
T3	+130°C (+266°F)	-40°C (-40°F)

T27-1.EPS

Ambient Temp.: -40°C to +60°C (-40°F to +140°F)

For CSA E79 Series

Flameproof for Zone 1, Ex dme[ia] IIC T6...T3
 Intrinsically safe (electrodes), Ex ia IIC T6...T3

Electrode Circuit Um: 250 Vac/dc
 Maximum power supply voltage: 250 Vac/130 Vdc
 Excitation Circuit: 140V max
 Enclosure: IP66, IP67
 Temperature Code:

Temperature Code	Maximum Process Temperature	Minimum Process Temperature
T6	+70°C (+158°F)	-40°C (-40°F)
T5	+85°C (+185°F)	-40°C (-40°F)
T4	+120°C (+248°F)	-40°C (-40°F)
T3	+130°C (+266°F)	-40°C (-40°F)

T27-1.EPS

Ambient Temp.: -40°C to +60°C (-40°F to +140°F)

(Remote Flowtube)

For CSA C22.2 Series

Explosion proof for Class I, Division 1, Groups A, B, C & D.
 Dust-ignition proof for Class II/III, Division 1, Groups E, F & G.
 Intrinsically safe (electrodes) for Class I, Division 1, Groups A, B, C & D.
 "SEAL ALL CONDUITS WITHIN 50 cm OF THE ENCLOSURE"
 "WHEN INSTALLED IN DIV. 2, SEALS NOT REQUIRED"

Electrode Circuit Um: 250 Vac/dc
 Excitation Circuit: 170V max
 Enclosure: Type 4X
 Temperature Code:

Temperature Code	Maximum Process Temperature	Minimum Process Temperature
T6	+70°C (+158°F)	-40°C (-40°F)
T5	+85°C (+185°F)	-40°C (-40°F)
T4	+120°C (+248°F)	-40°C (-40°F)
T3	+150°C (+302°F)	-40°C (-40°F)

T28-1.EPS

Ambient Temp.: -40°C to +60°C (-40°F to +140°F)

For CSA E79 Series

Flameproof for Zone 1, Ex dme[ia] IIC T6...T3
 Intrinsically safe (electrodes), Ex ia IIC T6...T3

Electrode Circuit Um: 250 Vac/dc
 Excitation Circuit: 170V max
 Enclosure: IP66, IP67
 Temperature Code:

Temperature Code	Maximum Process Temperature	Minimum Process Temperature
T6	+70°C (+158°F)	-40°C (-40°F)
T5	+85°C (+185°F)	-40°C (-40°F)
T4	+120°C (+248°F)	-40°C (-40°F)
T3	+150°C (+302°F)	-40°C (-40°F)

T28-1.EPS

Ambient Temp.: -40°C to +60°C (-40°F to +140°F)

IECEX:

*AXF002C – AXF400C
 Applicable Standard:
 IEC60079-0, IEC60079-1, IEC60079-7,
 IEC60079-11, IEC60079-18, IEC61241-0,
 IEC61241-1, IEC60529 + Edition 2.1
 Certificate: IECEX KEM 05.0018

(Integral Flowmeter)

IECEX Flameproof Type

Ex demb[ia] IIC T6...T3
 Electrode Circuit Um: 250 Vac/dc
 Maximum power supply voltage: 250 Vac/130 Vdc
 Excitation Circuit: 140V max
 Enclosure: IP66, IP67
 Temperature Class:

Temperature Class	Process Temperature
T6	-40°C to +70°C (-40°F to +158°F)
T5	-40°C to +85°C (-40°F to +185°F)
T4	-40°C to +120°C (-40°F to +248°F)
T3	-40°C to +130°C (-40°F to +266°F)

T27-3.EPS

Ambient Temp.:
 PFA Lining; -40°C to +60°C (-40°F to +140°F)
 Ceramics Lining; -15°C to +60°C (5°F to +140°F)

IECEX Type of Protection "Dust"

Ex tD A21 IP6x T95°C, T105°C, T120°C, T130°C
 Electrode Circuit Um: 250 Vac/dc
 Maximum power supply voltage: 250 Vac/130 Vdc
 Excitation Circuit: 140V max
 Enclosure: IP66, IP67
 Maximum surface temperature:

Maximum Surface Temperature	Process Temperature
T95°C (+203°F)	-40°C to +70°C (-40°F to +158°F)
T105°C (+221°F)	-40°C to +85°C (-40°F to +185°F)
T120°C (+248°F)	-40°C to +120°C (-40°F to +248°F)
T130°C (+266°F)	-40°C to +130°C (-40°F to +266°F)

T27-4.EPS

Ambient Temp.:
 PFA Lining; -40°C to +60°C (-40°F to +140°F)
 Ceramics Lining; -15°C to +60°C (5°F to +140°F)

(Remote Flowtube)

IECEx Flameproof Type

Ex demb[ia] IIC T6...T3
 Electrode Circuit Um: 250 Vac/dc
 Excitation Circuit: 170V max
 Enclosure: IP66, IP67
 Temperature Class:

Temperature Class	Process Temperature
T6	-40°C to +70°C (-40°F to +158°F)
T5	-40°C to +85°C (-40°F to +185°F)
T4	-40°C to +120°C (-40°F to +248°F)
T3	-40°C to +150°C (-40°F to +302°F)

T27-5.EPS

Ambient Temp.:
 PFA Lining; -40°C to +60°C (-40°F to +140°F)
 Ceramics Lining; -15°C to +60°C (5°F to +140°F)

IECEx Type of Protection “Dust”

Ex tD A21 IP6x T95°C, T105°C, T120°C, T135°C
 Electrode Circuit Um: 250 Vac/dc
 Excitation Circuit: 170V max
 Enclosure: IP66, IP67
 Maximum surface temperature:

Maximum Surface Temperature	Process Temperature
T95°C (+203°F)	-40°C to +70°C (-40°F to +158°F)
T105°C (+221°F)	-40°C to +85°C (-40°F to +185°F)
T120°C (+248°F)	-40°C to +120°C (-40°F to +248°F)
T135°C (+275°F)	-40°C to +150°C (-40°F to +302°F)

T27-6.EPS

Ambient Temp.:
 PFA Lining; -40°C to +60°C (-40°F to +140°F)
 Ceramics Lining; -15°C to +60°C (5°F to +140°F)

TIIS:

(Integral Flowmeter)

- Construction: Ex de[ia] IIC T4
 : Converter ; Explosion proof
 Flowtube ; Increased Safety and
 Intrinsically Safety(ia)
 Electrode ; Intrinsically Safety(ia)
- Gas Group and Temperature Class: IIC T4
- Ambient Temperature: -20 to 60°C* (power supply code 1)
 : -20 to 50°C (power supply code 2)
- Fluid Temperature: 120°C max
- Electrode Circuit: 250V AC/DC
- Maximum power supply voltage: 250V AC/130V DC
- Grounding: JIS Class C(grounding resistance 10Ω or less) or JIS Class A(grounding resistance 10Ω or less)

*In case that ambient temperature exceeds 50°C, use heat-resistant cables with maximum allowable temperature of 70°C or above.

(Remote Flowtube)

- Construction: Ex de[ia] IIC T4
 : Terminal box ; Explosion proof
 Flowtube ; Increased Safety and
 Intrinsically Safety(ia)
 Electrode; Intrinsically Safety(ia)
- Gas Group and Temperature Class: IIC T4
- Ambient Temperature: -20 to 60°C*
- Fluid Temperature: 120°C max
- Electrode Circuit: 250V AC/DC
- Grounding: JIS Class C(grounding resistance 10Ω or less) or JIS Class A(grounding resistance 10Ω or less)

*In case that ambient temperature exceeds 50°C, use heat-resistant cables with maximum allowable temperature of 70°C or above.

Note : In case of TIIS Flameproof type, a remote flowtube is available for combined use with the AXFA14 converter only.

STANDARD PERFORMANCE

Accuracy

Note: The accuracy of a product before shipment is defined as totalized value at the result of calibration test in our water actual flow test facility.

Calibrated conditions in our water actual test facility are as follows:

- Fluid temperature; 20 ± 10°C
- Ambient temperature; 20 ± 5°C
- Length of straight runs; 10 D or more on the upstream side; 5 D or more on the downstream side

Reference conditions; Similar to BS EN29104 (1993); ISO 9104 (1991)

Pulse Output:

PFA/Ceramics Lining:

Size mm (in.)	Flow Velocity V m/s (ft/s)	Standard Accuracy (Calibration code B)	Flow Velocity V m/s (ft/s)	High Grade Accuracy (Calibration code C)
2.5 (0.1) to 15 (0.5)	V < 0.3 (1)	±1.0 mm/s	—	—
	0.3 ≤ V ≤ 10 (1) (33)	±0.35% of Rate		
25 (1.0) to 200 (8.0)	V < 0.15 (0.5)	±0.5 mm/s	V < 0.15 (0.5)	±0.5 mm/s
	0.15 ≤ V ≤ 10 (0.5) (33)	±0.35% of Rate	0.15 ≤ V < 1 (0.5) (3.3)	±0.18% of Rate ± 0.2mm/s
			1 ≤ V ≤ 10 (3.3) (33)	±0.2% of Rate
250 (10) to 400 (16)	V < 0.15 (0.5)	±0.5 mm/s	—	—
	0.15 ≤ V ≤ 10 (0.5) (33)	±0.35% of Rate		

Enhanced dual frequency excitation(Option code HF2): Standard accuracy ±1 mm/ s

Size 2.5 mm (0.1 in.) to 15 mm (0.5 in.)

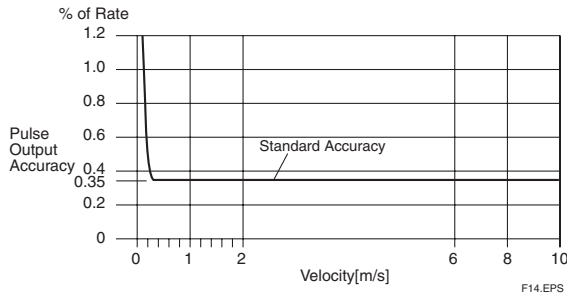

Size 25 mm (1.0 in.) to 400 mm (16 in.)

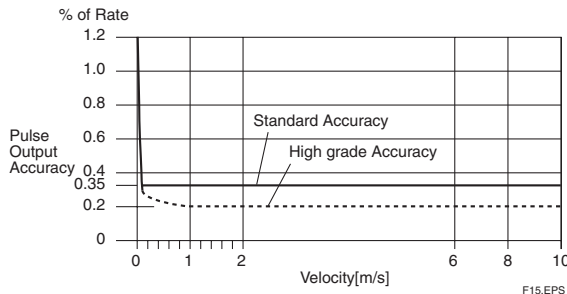

Polyurethane Rubber /Natural Soft Rubber / EPDM Rubber Lining:

Size mm (in.)	Flow Velocity V m/s (ft/s)	Standard Accuracy (Calibration code B)
25 (1.0) to 400 (16)	V < 0.3 (1.0)	±1.0 mm/s
	0.3 ≤ V ≤ 10 (1.0) (33)	±0.35% of Rate

Enhanced dual frequency excitation(Optional code HF2) : Standard accuracy ±1 mm/ s

Size 25 mm (1.0 in.) to 400 mm (16 in.)

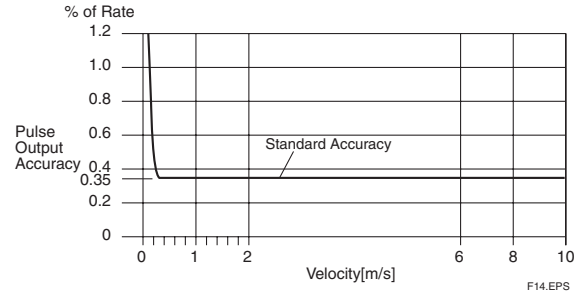

Current Output “◇”: Pulse output accuracy plus ±0.05% of Span

Repeatability:

- ±0.1% of Rate (V ≥ 1 m/s (3.3 ft/s))
- ±0.05% of Rate ±0.5 mm/s (V < 1 m/s (3.3 ft/s))

Maximum Power Consumption:

- Integral Flowmeter: 12W
- Remote Flowtube: Combined with AXFA11: 20W
- Combined with AXFA14: 12W

Insulation Resistance (*1):

- Integral Flowmeter:
 - Between power supply terminals and ground terminalm : 100MΩ at 500V DC
 - Between power supply terminals and input /output terminals : 100MΩ at 500V DC
 - Between ground terminal and input/output terminals : 20MΩ at 100V DC
 - Between input/output terminals : 20MΩ at 100V DC
- Remote Flowtube:
 - Between excitation current terminal and signal / common terminals : 100MΩ at 500V DC
 - Between signal terminals : 100MΩ at 500V DC
 - Between signal terminals and common terminal (C) : 100MΩ at 500V DC

Withstand Voltage (*1):

- Integral Flowmeter
 - Between power supply terminals and ground terminal : 1400V AC for 2 seconds
 - Between power supply terminals and input/output terminals : 1400V AC for 2 seconds
- Remote Flowtube (optional code JF3, KF2, CF1, and SF2)
 - Between excitation current terminal and ground terminal : 1500V AC for 1 minute
 - Between signal terminals and ground terminal : 1500V AC for 1 minute
 - Between signal terminals and excitation current terminal : 2000V AC for 1 minute

Remote Flowtube (optional code FF1)
 Between signal terminals and ground terminal : 500V AC for 1 minute or 600V AC for 1 second
 Between signal terminals and excitation current terminal : 2000V AC for 1 minute or 2400V AC for 1 second.

Remote Flowtube (optional code WT1)
 Between excitation current terminal and ground terminal : 1000V AC for 1 minute

Remote Flowtube (optional code WT2)
 Between excitation current terminal and ground terminal : 1500V AC for 1 minute
 Between signal terminals and excitation current terminal : 1500V AC for 1 minute

 **CAUTION**

- *1: When performing the Insulation Resistance Test or the Withstand Voltage Test, please obey the following caution.
- Following the relevant test, wait for more than 10 seconds after the power supply has been turned off before removing the cover.
 - Remove all wires from terminals before testing.
 - When the power terminal has a lighting protector (optional code A), remove the short bar at the ground terminal.
 - After testing, be sure to discharge by using a resistance and return all wires and the short bar to its correct position.
 - Screws must be tightened to a torque of 1.18 N·m or more.
 - After closing the cover, the power supply can be restored.

Safety Requirement Standards:

- EN61010-1
 EN61010-2-030
- Altitude at installation site: Max. 2000 m above sea level
 - Installation category based on IEC1010:
 Overvoltage category II ("II" applies to electrical equipment which is supplied from the fixed installation like distribution board.)
 - Pollution degree based on IEC1010
 Pollution degree 2 ("Pollution degree" describes the degree to which a solid, liquid, or gas which deteriorates dielectric strength or surface resistivity is adhering. "2" applies to a normal indoor atmosphere.)

EMC Conformity Standards:  , 

- EN61326-1 Class A, Table 2 (For use in industrial locations)
 EN61326-2-3
 EN61326-2-5 (for FOUNDATION fieldbus/PROFIBUS only)
 EN61000-3-2 Class A
 EN61000-3-3

Pressure Equipment Directive:

Module: H
 Type of Equipment: Piping
 Type of Fluid: Liquid and Gas
 Group of Fluid: 1 and 2

General-Purpose Use/Submersible Type/Explosion proof Type:

MODEL	DN (mm) (*1)	PS (MPa) (*1)	PS DN (MPa · mm)	CATEGORY(*2)
AXF002G/C	2.5	4	10	Article 3, (*3) paragraph 3
AXF005G/C	5	4	20	Article 3, (*3) paragraph 3
AXF010G/C	10	4	40	Article 3, (*3) paragraph 3
AXF015G/W/C	15	4	60	Article 3, (*3) paragraph 3
AXF025G/W/C	25	4	100	Article 3, (*3) paragraph 3
AXF032G/W/C	32	4	128	II
AXF040G/W/C	40	4	160	II
AXF050G/W/C	50	4	200	II
AXF065G/W/C	65	2	130	II
AXF080G/W/C	80	2	160	II
AXF100G/W/C	100	2	200	II
AXF125G/W/C	125	2	250	II
AXF150G/W/C	150	2	300	II
AXF200G/W/C	200	2	400	III
AXF250G/W/C	250	2	500	III
AXF300G/W/C	300	2	600	III
AXF350G/W/C	350	1	350	II
AXF400G/W/C	400	1	400	III

T10-1.EPS

Sanitary Type:

MODEL	DN (mm) (*1)	PS (MPa) (*1)	PS D (MPa · mm)	CATEGORY (*2)
AXF015H	15	1	15	Article 3, (*3) paragraph 3
AXF025H	25	1	25	Article 3, (*3) paragraph 3
AXF032H	32	1	32	I
AXF040H	40	1	40	I
AXF050H	50	1	50	I
AXF065H	65	1	65	I
AXF080H	80	1	80	I
AXF100H	100	1	100	I
AXF125H	125	1	125	II

T10-2.EPS

- *1: PS: Maximum allowable pressure for Flowtube
 DN: Nominal size
 *2: For details, see "Table 6 covered by ANNEX II of EC Directive on Pressure Equipment Directive 97/23/EC."
 *3: AXF002G/C to AXF025G/W/C, AXF015H and AXF025H are outside the scope of CE marking of PED.

NORMAL OPERATING CONDITIONS

Ambient Temperature: -40 to +60°C (-40 to +140°F)

- *1: Minimum temperature should also be limited according to minimum fluid temperature of flow tube's specification. Refer to description of "Fluid Temperature and Pressure".
- *2: Indicator's operating range (integral flowmeter): -20 to +60°C (-4 to +140°F)
- *3: Maximum temperature should be +50°C (+122°F) in the case of power supply code 2 (integral flowmeter).

Ambient Humidity: 0 to 100%

Lengthy continuous operation at 95% or more is not recommended.

Power Supply (integral flowmeter):

Power supply code 1:

- AC specifications
Rated power supply: 100 to 240 V AC, 50/60 Hz
(Operating voltage range: 80 to 264 V AC)
- DC specifications
Rated power supply: 100 to 120 V DC
(Operating voltage range: 90 to 130 V DC)

Power supply code 2:

- AC specifications
Rated power supply: 24 V AC, 50/60 Hz
(Operating voltage range: 20.4 to 28.8 V AC)
- DC specifications
Rated power supply: 24 V DC
(Operating voltage range: 20.4 to 28.8 V DC)

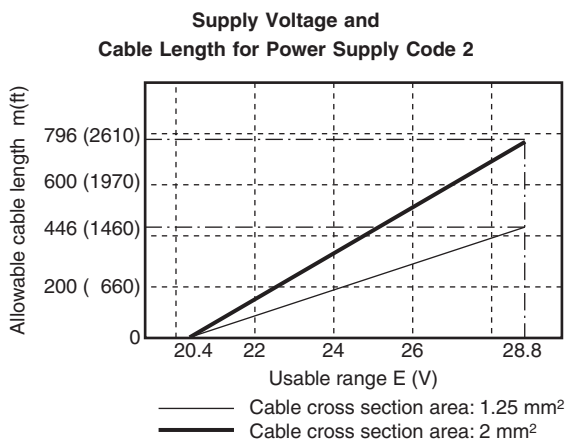

F01.EPS

Fluid Conductivity:

- Size 2.5 to 10 mm (0.1 to 0.4 in.): 5 μS/cm or larger
- Size 15 to 125 mm (0.5 to 5 in.): 1 μS/cm or larger
- Size 150 to 400 mm (6 to 16 in.): 3 μS/cm or larger

Note: Fluids with large flow noise (pure water, fluid with low conductivity and low viscosity such as alcohol) cause the output fluctuation. Be careful that it affects the flow rate measurement. It is recommended to use the CA capacitance magnetic flowmeter.

Cable Length and Liquid Conductivity (Remote Flowtube):

Size 2.5 to 10 mm (0.1 to 0.4 in.)

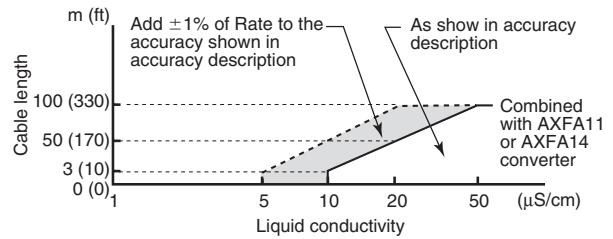

Size 15 to 125 mm (0.5 to 5.0 in.)

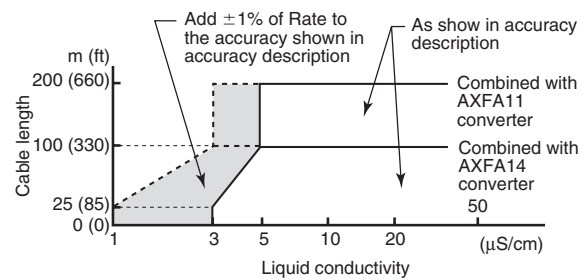

Size 150 to 400 mm (6.0 to 16 in.)

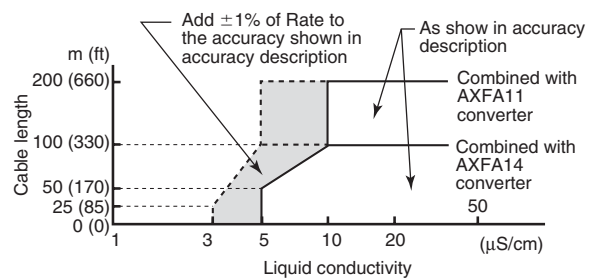

F03.EPS

Note: In case that size 250 or 300 mm (10 or 12 in.) is used for high conductivity fluid (ex. caustic soda, seawater), please use the flange type.

Measurable Flow Rate Range:

SI Units (Size: mm, Flow rate: m³/h)

Size (mm)	0 to Min. Span Flow Rate (0.1 m/s)	0 to Max. Span Flow Rate (10 m/s)
2.5	0 to 0.0018 m ³ /h	0 to 0.1767 m ³ /h
5	0 to 0.0071	0 to 0.7068
10	0 to 0.0283	0 to 2.8274
15	0 to 0.0637	0 to 6.361
25	0 to 0.1768	0 to 17.671
32	0 to 0.2896	0 to 28.952
40	0 to 0.4524	0 to 45.23
50	0 to 0.7069	0 to 70.68
65	0 to 1.1946	0 to 119.45
80	0 to 1.8096	0 to 180.95
100	0 to 2.8275	0 to 282.74
125	0 to 4.418	0 to 441.7
150	0 to 6.362	0 to 636.1
200	0 to 11.310	0 to 1,130.9
250	0 to 17.672	0 to 1,767.1
300	0 to 25.447	0 to 2,544.6
350	0 to 34.64	0 to 3,463
400	0 to 45.24	0 to 4,523

T11.EPS

English Units (Size: in., Flow rate: GPM)

Size (in.)	0 to Min. Span Flow Rate (0.33ft/s)	0 to Max. Span Flow Rate (33ft/s)
0.1	0 to 0.0078 GPM	0 to 0.7780 GPM
0.2	0 to 0.0312	0 to 3.112
0.4	0 to 0.1245	0 to 12.44
0.5	0 to 0.1946	0 to 19.45
1.0	0 to 0.7781	0 to 77.80
1.25	0 to 1.216	0 to 121.5
1.5	0 to 1.751	0 to 175.0
2.0	0 to 3.113	0 to 311.2
2.5	0 to 4.863	0 to 486.2
3.0	0 to 7.003	0 to 700.2
4.0	0 to 12.45	0 to 1,244
5.0	0 to 19.46	0 to 1,945
6.0	0 to 28.01	0 to 2,800
8.0	0 to 49.80	0 to 4,979
10	0 to 77.81	0 to 7,780
12	0 to 112.1	0 to 11,203
14	0 to 152.5	0 to 15,249
16	0 to 199.2	0 to 19,918

T24.EPS

Fluid Temperature and Pressure:

The following figures show maximum allowable fluid pressure for the flowtube. Further fluid pressure should also be limited according to flange rating.

For fluid temperature of the explosion proof type, refer to descriptions of "HAZARDOUS AREA CLASSIFICATION".

PFA Lining (*1)

General-Purpose Use, Submersible Type, Explosion proof Type, Remote Flowtube (electrode structure code 1: Non-replaceable electrode)

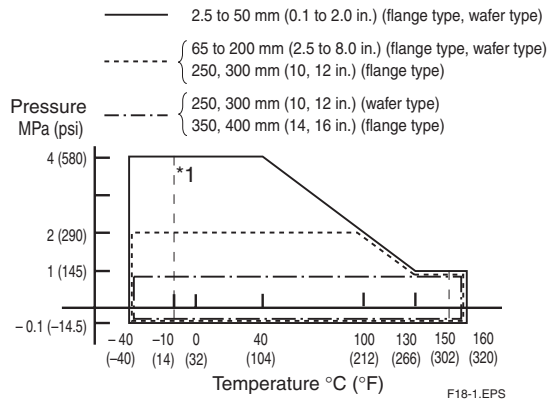

F18-1.EPS

General-Purpose Use and Explosion proof Type, Integral Flowmeter (electrode structure code 1: Non-replaceable electrode)

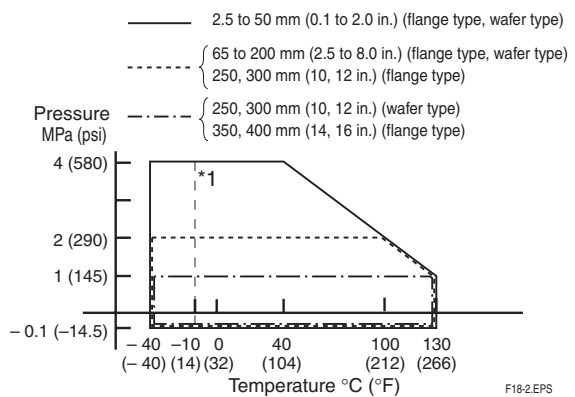

F18-2.EPS

*1: For wafer types of 32 mm to 300 mm (1.25 to 12 in.) and carbon steel flange types (process connection code: C**) of 50 to 400 mm (2.0 to 16 in.), the minimum temperature is -10°C (14°F).

*2: For fluid temperature of the explosion proof type, refer to descriptions of "HAZARDOUS AREA CLASSIFICATION".

General-Purpose Use, Remote Flowtube (electrode structure code 2: replaceable electrode)

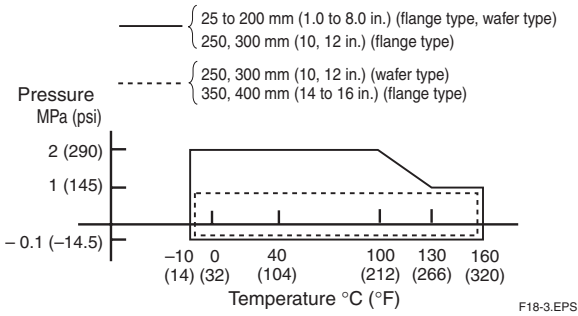

General-Purpose Use, Integral Flowmeter (electrode structure code 2: replaceable electrode)

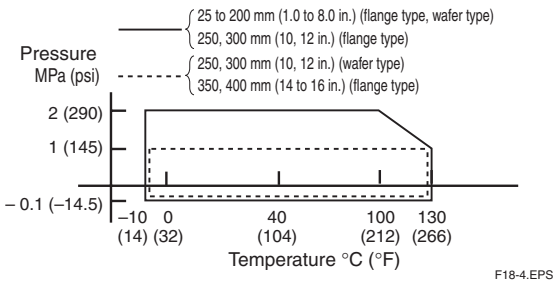

Note: For replaceable electrodes for fluid temperatures of -10°C (14°F) or less, please contact Yokogawa office.

Sanitary Type (electrode structure code 1: Non-replaceable electrode)

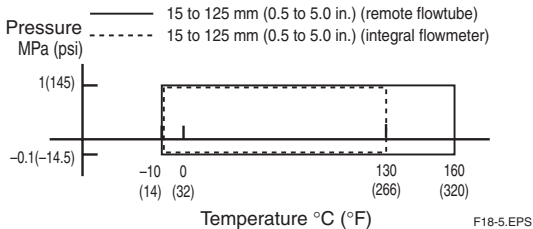

Note: In case of 120 to 160°C (248 to 320°F) of fluid temperature, please select optional code GH.

Ceramics Lining

General-Purpose Use and Explosion proof Type, Remote Flowtube (electrode structure code 1: Non-replaceable electrode)

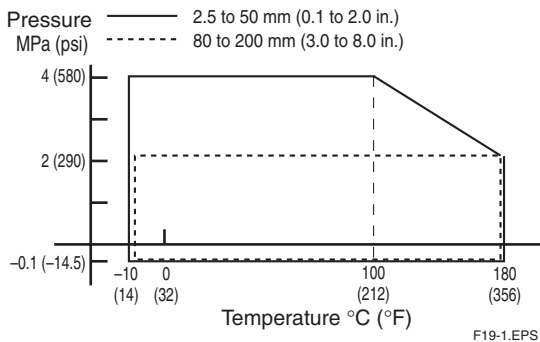

General-Purpose Use and Explosion proof Type, Integral flowmeter (electrode structure code 1: Non-replaceable electrode)

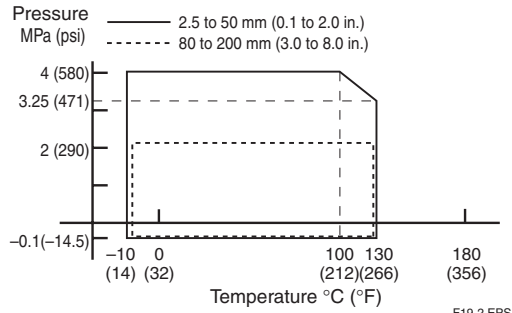

*1: For fluid temperature of the explosion proof type, refer to descriptions of "HAZARDOUS AREA CLASSIFICATION".

Polyurethane Rubber Lining

General-Purpose Use and Submersible Type, Remote Flowtube (electrode structure code 1: Non-replaceable electrode)

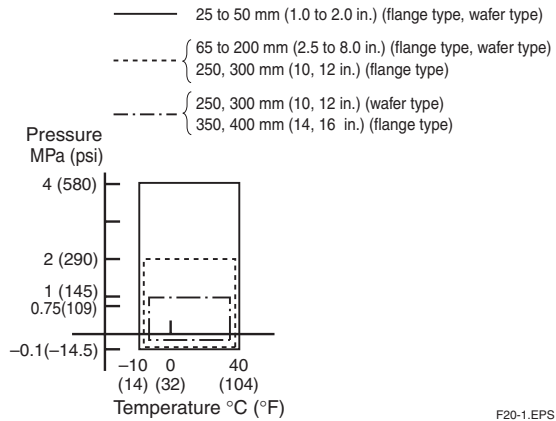

General-Purpose Use, Integral Flowmeter (electrode structure code 2: replaceable electrode)

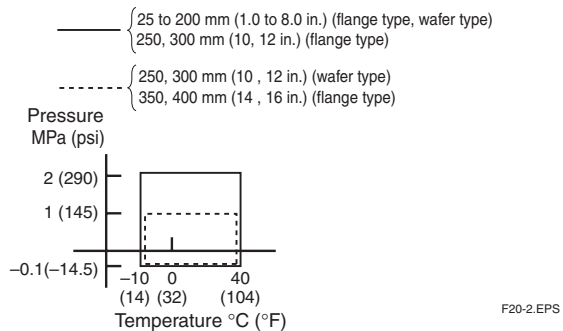

Natural Soft Rubber Lining

**General-Purpose Use and Submersible Type,
Remote Flowtube (electrode structure code 1: Non-
replaceable electrode)**

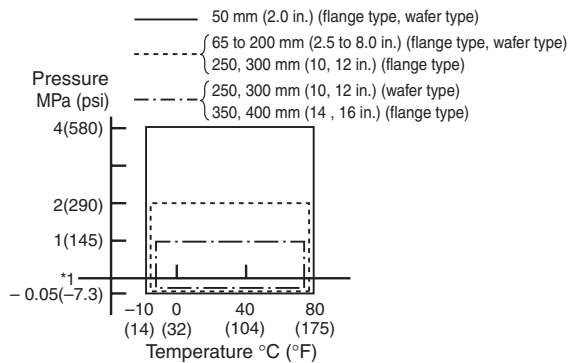

*1 : -0.04 MPa (-5.7 psi) for sizes of 350 mm (14 in.) and 400 mm (16 in.)
F05-2.EPS

EPDM Rubber Lining

**General-Purpose Use and Submersible Type,
Remote Flowtube (electrode structure code 1: Non-
replaceable electrode)**

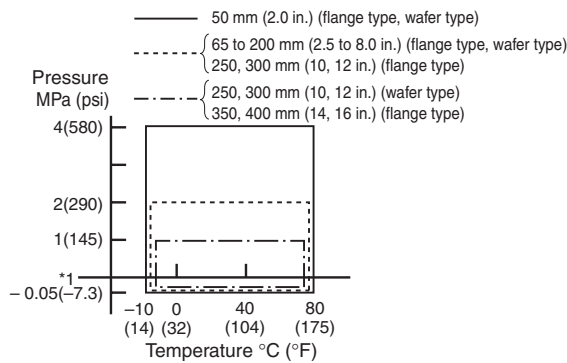

*1 : -0.04 MPa (-5.7 psi) for sizes of 350 mm (14 in.) and 400 mm (16 in.)
F05-3.EPS

Reasonable Figure for Thermal Shock of Ceramics Lining:

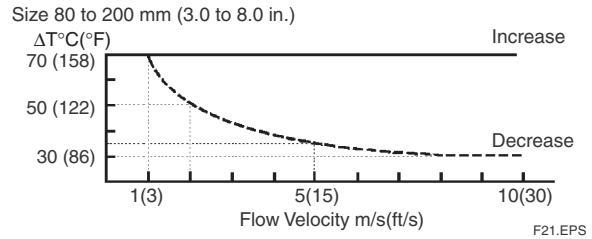
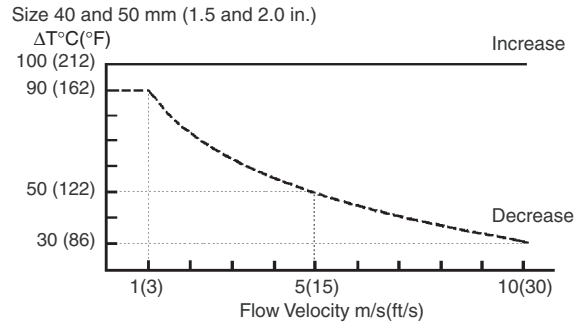
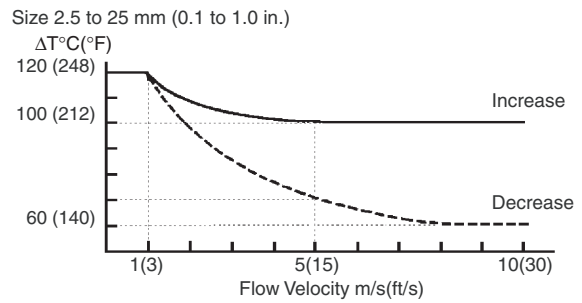

“Decrease” means that the temperature of a measured fluid drops rapidly, while “Increase” means that the temperature rises rapidly. The maximum allowable ranges in both cases are indicated by the curves shown in the diagrams, with the solid line indicating the maximum increase, and the broken line the maximum decrease.

ΔT : Change in temperature of measured fluid in one second
Flow velocity: flow velocity of the measured fluid

Allowable Conditions for Cleaning Sanitary Type Linings

Steam or hot water cleaning: Max.temp.= 150 °C (302°F),
time= 60 minutes or less

Vibration Conditions:

Level of vibration in conformity with IEC 60068-2-6 (SAMA 31.1-1980)

- Integral Flowmeter:
9.8 m/s² or less (frequency of 500 Hz or less)
- Remote Flowtube:
19.6 m/s² or less (frequency of 500 Hz or less)

Note: Avoid locations with much vibration (where the pipe vibration frequency is 500 Hz or more), which may cause damage to the equipment.

CAUTIONS FOR INSTALLATION

Mounting of Flowmeters and Required Lengths of Straight Runs

Based on JIS B 7554 and our piping condition test data, we recommend the piping conditions as shown in the following figures.

When installing two or more magnetic flowmeters on a single pipe, provide a run of at least 10D between them.

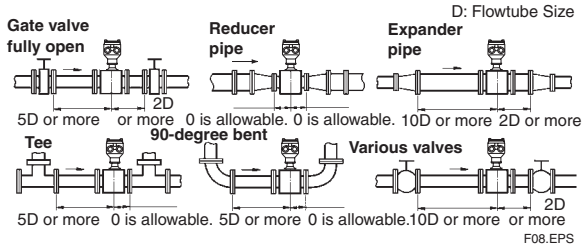

Required straight runs

- *1: Do not install anything in the vicinity that may interfere with the magnetic field, induced signal voltages, or flow velocity distributions of the flowmeter.
- *2: A straight run may not be required on the downstream side of the flowmeter. However, if a downstream valve or other fitting causes irregularity or deviation in flows, provide a straight run of 2D to 3D on the downstream side.
- *3: The valves shall be mounted on the downstream side so that deviated flows do not occur in the flowtube and to avoid startup from an empty condition.

Maintaining Stable Fluid Conductivity

Do not install the flowmeter where fluid conductivity tends to become uneven. If chemicals are fed near the upstream side of a magnetic flowmeter, they may affect the flow-rate's indications. To avoid this situation, it is recommended that the chemical feed ports be located on the downstream side of the flowmeter. If it is unavoidable that chemicals must be fed on the upstream side, provide a sufficient length of straight run (approximately 50D) to ensure the proper mixture of fluids.

Mounting Positions

• Pipes must be fully filled with liquids.

It is essential that pipes remain fully filled at all times, otherwise flow rate indications may be affected and measurement errors may be caused. Piping shall be designed so as to maintain the flowtube filled with fluids.

Vertical mounting is effective in such cases as when fluids tend to separate or solid matter may be precipitated. When employing vertical mounting, direct the fluids from the bottom to the top to ensure that the pipes remain fully filled.

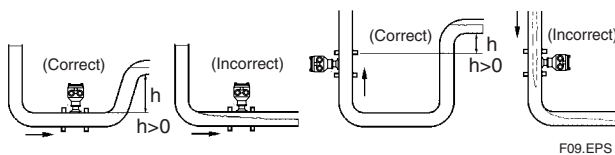

Mounting Positions

• Avoiding Air Bubbles.

If air bubbles enter a measurement pipe, flow rate indications may be affected and measurement errors may be caused.

In cases where fluids contain air bubbles, piping must be designed to prevent them from accumulating in the measurement pipe of a flowtube.

If a valve exists near the flowtube, try to mount the flowtube on the valve's upstream side in order to prevent a possible reduction of pressure inside the pipe, thereby avoiding the possibility of air bubbles.

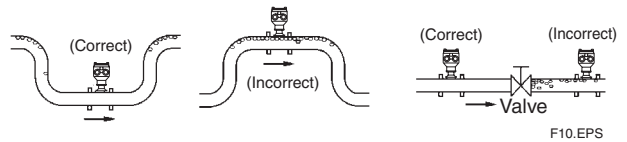

Avoiding Air Bubbles

• Mounting Orientation

If electrodes are perpendicular to the ground, air bubbles near the top or precipitates at the bottom may cause measurement errors.

Ensure that the terminal box of a remote flowtube and converter of an integral flowmeter are mounted above the piping to prevent water from entering them.

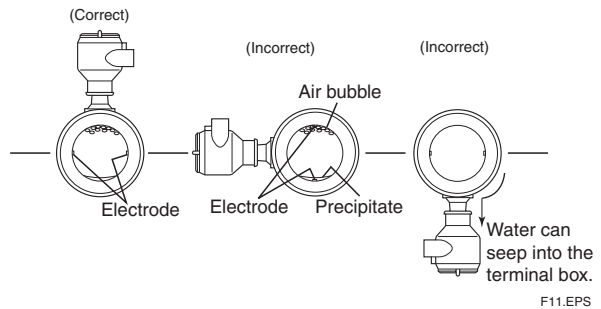

Mounting Orientation

ACCESSORIES

Centering device (wafer type only): 1 pc.
Hexagonal wrench: 2 pcs.

TERMINAL CONFIGURATION AND TERMINAL WIRING

● **Integral Flowmeter “◇”**

Terminal configuration

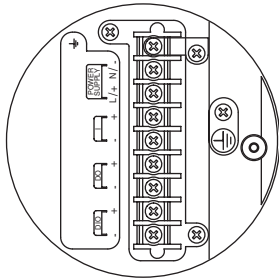

Terminal wiring

Terminal Symbols	Description
	Functional grounding
N/- L/+	Power supply
I+ I-	Current output 4 to 20mA DC
DO+ DO-	Pulse output/Alarm output/ Status output
DIO+ DIO-	Alarm output/Status output Status input
	Protective grounding (Outside of the terminal)

F41.EPS

● **Recommended Excitation, Power and Output Cable:**

JIS C 3401 control cable equivalent
JIS C 3312 power cable equivalent
14 AWG Belden 8720 equivalent
Outer Diameter:
With no gland option;
6.5 to 12 mm (0.26 to 0.47 in.)
With gland options EG,EU and EW;
10.5 or 11.5 mm (0.41 or 0.45 in.)
With gland options EP;
6 to 12 mm (0.24 to 0.47 in.)
Nominal Cross Section:
Single wire: 0.5 to 2.5 mm²
Stranded wire: 0.5 to 1.5 mm²

● **Remote Flowtube**

Terminal configuration

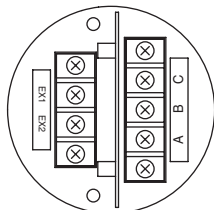

For other than Explosion proof type

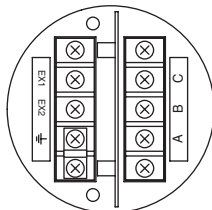

For Explosion proof type

F42.EPS

Terminal wiring

Terminal Symbols	Description
A B C	Flow signal output
EX1 EX2	Excitation current input
	Functional grounding (Only for explosion proof type)
	Protective grounding (Outside of the terminal)

F42_2.EPS

Note: When submersible type or optional code DHC is selected, waterproof glands and a 30m long cable are attached.

MODEL AND SUFFIX CODE

AXF STANDARD (Wafer Type)

General-purpose Use/Submersible Type/Explosion proof Type, PFA/Polyurethane Rubber/Natural Soft Rubber/EPDM Rubber Lining

Model	Suffix Code	Description	Applicable Model
AXF002	Size 2.5 mm (0.1 in.) Integral Flowmeter/Remote Flowtube	
AXF005	Size 5 mm (0.2 in.) Integral Flowmeter/Remote Flowtube	
AXF010	Size 10 mm (0.4 in.) Integral Flowmeter/Remote Flowtube	
AXF015	Size 15 mm (0.5 in.) Integral Flowmeter/Remote Flowtube	
AXF025	Size 25 mm (1.0 in.) Integral Flowmeter/Remote Flowtube	
AXF032	Size 32 mm (1.25 in.) Integral Flowmeter/Remote Flowtube	
AXF040	Size 40 mm (1.5 in.) Integral Flowmeter/Remote Flowtube	
AXF050	Size 50 mm (2.0 in.) Integral Flowmeter/Remote Flowtube	
AXF065	Size 65 mm (2.5 in.) Integral Flowmeter/Remote Flowtube	
AXF080	Size 80 mm (3.0 in.) Integral Flowmeter/Remote Flowtube	
AXF100	Size 100 mm (4.0 in.) Integral Flowmeter/Remote Flowtube	
AXF125	Size 125 mm (5.0 in.) Integral Flowmeter/Remote Flowtube	
AXF150	Size 150 mm (6.0 in.) Integral Flowmeter/Remote Flowtube	
AXF200	Size 200 mm (8.0 in.) Integral Flowmeter/Remote Flowtube	
AXF250	Size 250 mm (10 in.) Integral Flowmeter/Remote Flowtube	
AXF300	Size 300 mm (12 in.) Integral Flowmeter/Remote Flowtube	
Use	G	General-Purpose Use	
	W	Submersible Type	Size 15 mm (0.5 in.) to 300 mm (12 in.) Remote Flowtube only
	C	Explosion proof Type (*5)	PFA lining only
Converter Output Signal and Communication	-D	Integral Flowmeter with 4 to 20mA DC Output and BRAIN Communication	
	-E	Integral Flowmeter with 4 to 20 mA DC Output and HART Communication	
	-F	Integral Flowmeter with Digital communication (FOUNDATION Fieldbus protocol) (*9)	
	-G	Integral Flowmeter with Digital communication (PROFIBUS PA protocol) (*10)	
	-N	Remote Flowtube for Combined Use with AXFA11	
	-P	Remote Flowtube for Combined Use with AXFA14	
Power Supply	1	Integral Flowmeter, 100 V to 240 V AC or 100 to 120 V DC	
	2	Integral Flowmeter, 24V AC/DC	
	N	Remote Flowtube	
Lining (*8)	A	Fluorocarbon PFA	
	U	Polyurethane Rubber	Size 25 mm (1.0 in.) to 300 mm (12 in.)
	D	Natural Soft Rubber	Size 50 mm (2.0 in.) to 300 mm (12 in.)
	G	EPDM Rubber	Size 50 mm (2.0 in.) to 300 mm (12 in.)
Electrode Material (*8)	L	JIS SUS316L (AISI 316L SS/EN 1.4404 Equivalent)	
	P	Platinum-iridium	PFA lining only
	H	Hastelloy C276 Equivalent	
	T	Tantalum	PFA lining only
	V	Titanium	
	W	Tungsten Carbide	Size 15 mm (0.5 in.) to 300 mm (12 in.), PFA/Polyurethane Rubber lining only
Electrode Structure	1	Non-replaceable	
	2	Replaceable	General-Purpose use, Size 25 mm (1.0 in.) to 300 mm (12 in.), PFA/Polyurethane Rubber lining only Electrode Material: JIS SUS316L only
Grounding Ring and Grounding Electrode Material (*8)	N	None	
	S	JIS SUS316 (AISI 316 SS/EN 1.4401 Equivalent)	
	L	JIS SUS316L (AISI 316L SS/EN 1.4404 Equivalent)	
	P	Platinum-iridium	Size 2.5 mm (0.1 in.) to 200 mm (8.0 in.), PFA lining only
	H	Hastelloy C276 Equivalent	
	T	Tantalum	Size 2.5 mm (0.1 in.) to 200 mm (8.0 in.), PFA lining only
	V	Titanium	
Process Connection (*3)(*11)	-AA1	ANSI Class 150 Wafer (*1)	Size 2.5 mm (0.1 in.) to 300 mm (12 in.)
	-AA2	ANSI Class 300 Wafer (*1)	Size 2.5 mm (0.1 in.) to 200 mm (8.0 in.)
	-AD1	DIN PN 10 Wafer (*2)	Size 200 mm (8.0 in.) to 300 mm (12 in.)
	-AD2	DIN PN 16 Wafer (*2)	Size 65 mm (2.5 in.) to 300 mm (12 in.)
	-AD4	DIN PN 40 Wafer (*1)(*2)	Size 2.5 mm (0.1 in.) to 50 mm (2.0 in.)
	-AJ1	JIS 10K Wafer (*1)	Size 2.5 mm (0.1 in.) to 300 mm (12 in.)
	-AJ2	JIS 20K Wafer (*1)	Size 2.5 mm (0.1 in.) to 200 mm (8.0 in.)
	-AG1	JIS F12 (JIS75M) Wafer	Size 80 mm (3.0 in.) to 300 mm (12 in.)
Lay Length	1	Standard	
Electrical Connection (*6)	-0	JIS G1/2 female	
	-2	ANSI 1/2 NPT female	Not available for Submersible Type
	-4	ISO M20×1.5 female	Not available for Submersible Type
Indicator (*4)(*7)	1	Integral Flowmeter with indicator (Horizontal)	
	2	Integral Flowmeter with indicator (Vertical)	
	N	Integral Flowmeter without indicator /Remote Flowtube	
Calibration	B	Standard	
	C	High Grade (*12)	Size 25 mm (1.0 in.) to 200 mm (8.0 in.), PFA lining only
Option	/□	Optional code (See the Table of Optional Specifications)	

T15.EPS

- *1: For a wafer type of 2.5 to 10 mm (0.1 to 0.4 in.), prepare 15 mm (0.5 in.) diameter nominal flanges on the process pipe side.
(Process connection codes: AA1, AA2, AD4, AJ1, and AJ2)
- *2: Even when DIN PN10 or 16 is required for a model of size 2.5 to 50 mm (0.1 to 2.0 in.), select PN40 (Process connection code: AD4) because there is no difference in the dimensions of the mating faces.
Even when DIN PN10 is required for a model of size 65 to 150 mm (2.5 to 6.0 in.), select PN16 (Process connection code: AD2) because there is no difference in the dimensions of the mating faces.
- *3: Mating dimensions are based on standards as follow:
ANSI:ASME B 16.5, DIN: DIN 2501, JIS:JIS B 2220 and JIS G 3443-2
- *4: N shall be always selected for remote flowtubes
In the case of an integral flowmeter, select from among the figures at the right:
- *5: For explosion proof types, specify types of explosion proof certification using the optional codes. In case of TIIS flameproof type, the remote flowtube is available only for combined use with the AXFA14. For the TIIS flameproof type with wiring using a flameproof packing adapter, select optional code G12 or G11. Available only for JIS G1/2 female electrical connections.
- *6: For explosion proof types, JIS G1/2 female electrical connection is available only for TIIS flameproof type.
- *7: In case of integral flowmeters of the TIIS flameproof type, select "with indicator"(code 1 or 2).
- *8: Δ Users must consider the characteristics of selected wetted parts material and influence of process fluids.
The use of inappropriate materials can result in the leakage of corrosive process fluids and cause injury to personnel and/or damage to plant facilities. It is also possible that the instrument itself can be damaged and that fragments from the instrument can contaminate the user's process fluids.
Be very careful with highly corrosive process fluids such as hydrochloric acid, sulfuric acid, hydrogen sulfide, sodium hypochlorite, and high-temperature steam (150°C [302°F] or above). Contact Yokogawa for detailed information of the wetted parts material.
- *9: For FOUNDATION Fieldbus protocol, refer to GS 01E20F02-01E
- *10: For PROFIBUS PA protocol, refer to GS 01E20F12-01E.
- *11: Allowable fluid pressure should also be limited according to fluid temperature and pressure.
- *12: In the case of calibration code C in remote type, please order a combination of flowtube and converter.

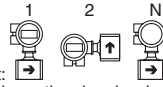

AXF STANDARD (Wafer /Union Joint Type)
General-purpose Use/Explosion proof Type, Ceramics Lining

Model	Suffix Code	Description	Applicable Model
AXF002	Size 2.5 mm (0.1 in.) Integral Flowmeter/Remote Flowtube	
AXF005	Size 5 mm (0.2 in.) Integral Flowmeter/Remote Flowtube	
AXF010	Size 10 mm (0.4 in.) Integral Flowmeter/Remote Flowtube	
AXF015	Size 15 mm (0.5 in.) Integral Flowmeter/Remote Flowtube	
AXF025	Size 25 mm (1.0 in.) Integral Flowmeter/Remote Flowtube	
AXF040	Size 40 mm (1.5 in.) Integral Flowmeter/Remote Flowtube	
AXF050	Size 50 mm (2.0 in.) Integral Flowmeter/Remote Flowtube	
AXF080	Size 80 mm (3.0 in.) Integral Flowmeter/Remote Flowtube	
AXF100	Size 100 mm (4.0 in.) Integral Flowmeter/Remote Flowtube	
AXF150	Size 150 mm (6.0 in.) Integral Flowmeter/Remote Flowtube	
AXF200	Size 200 mm (8.0 in.) Integral Flowmeter/Remote Flowtube	
Use	G	General-Purpose Use	
	C	Explosion proof Type(*5)	
Converter Output Signal and Communication	-D	Integral Flowmeter with 4 to 20 mA DC Output and BRAIN Communication	
	-E	Integral Flowmeter with 4 to 20 mA DC Output and HART Communication	
	-F	Integral Flowmeter with Digital communication (FOUNDATION Fieldbus protocol) (*9)	
	-G	Integral Flowmeter with Digital communication (PROFIBUS PA protocol) (*10)	
	-N	Remote Flowtube for Combined use with AXFA11	
	-P	Remote Flowtube for Combined use with AXFA14	
Power Supply	1	Integral Flowmeter, 100 V to 240 V AC or 100 to 120 V DC	
	2	Integral Flowmeter, 24 V AC/DC	
	N	Remote Flowtube	
Lining (*8)	C	Ceramics	
Electrode Material (*8)	E	Platinum-alumina Cermet	
Electrode Structure	1	Non-replaceable	
Grounding Ring and Grounding Electrode Material (*8)	N	None	Size 2.5 mm (0.1 in.) to 200 mm (8.0 in.)
	S	JIS SUS316 (AISI 316 SS/EN 1.4401 Equivalent)	Size 15 mm (0.5 in.) to 200 mm (8.0 in.)
	L	JIS SUS316L (AISI 316L SS/EN 1.4404 Equivalent)	Size 15 mm (0.5 in.) to 200 mm (8.0 in.)
	P	Platinum-iridium	Size 15 mm (0.5 in.) to 200 mm (8.0 in.)
	H	Hastelloy C276 Equivalent	Size 15 mm (0.5 in.) to 200 mm (8.0 in.)
	T	Tantalum	Size 15 mm (0.5 in.) to 200 mm (8.0 in.)
	V	Titanium	Size 15 mm (0.5 in.) to 200 mm (8.0 in.)
Process Connection (*2) (*11)	-AA1.....	ANSI Class 150 Wafer	Size 15 mm (0.5 in.) to 200 mm (8.0 in.)
	-AA2.....	ANSI Class 300 Wafer	Size 15 mm (0.5 in.) to 200 mm (8.0 in.)
	-AD1.....	DIN PN 10 Wafer (*1)	Size 200 mm (8.0 in.) only
	-AD2.....	DIN PN 16 Wafer (*1)	Size 80 mm (3.0 in.) to 200 mm (8.0 in.)
	-AD4.....	DIN PN 40 Wafer (*1)	Size 15 mm (0.5 in.) to 50 mm (2.0 in.)
	-AJ1.....	JIS 10K Wafer	Size 15 mm (0.5 in.) to 200 mm (8.0 in.)
	-AJ2.....	JIS 20K Wafer	Size 15 mm (0.5 in.) to 200 mm (8.0 in.)
	-AG1.....	JIS F12 (JIS75M) Wafer	Size 80 mm (3.0 in.) to 200 mm (8.0 in.)
	-GUW.....	Union Joint (Weld Joint) (*8)	Size 2.5 mm (0.1 in.) to 10 mm (0.4 in.)
	-GUN.....	Union Joint (1/4NPT Male for 2.5 or 5 mm dia.: 3/8NPT Male for 10 mm dia.) (*8)	Size 2.5 mm (0.1 in.) to 10 mm (0.4 in.)
	-GUR.....	Union Joint (R1/4 Male for 2.5 or 5 mm dia.: R3/8 Male for 10mm dia.) (*8)	Size 2.5 mm (0.1 in.) to 10 mm (0.4 in.)
Lay Length (*3)	1	Standard	
Electrical Connection (*6)	-0	JIS G1/2 female	
	-2	ANSI 1/2 NPT female	
	-4	ISO M20×1.5 female	
Indicator (*4)(*7)	1	Integral Flowmeter with indicator (Horizontal)	
	2	Integral Flowmeter with indicator (Vertical)	
	N	Integral Flowmeter without indicator /Remote Flowtube	
Calibration	B	Standard	
	C	High Grade (*12)	Size 25 mm (1.0 in.) to 200mm (8.0 in.)
Option	/□	Optional code (See the Table of Optional Specifications)	

T16.EPS

- *1: Even when DIN PN10 or 16 is required for a model of size 2.5 to 50 mm (0.1 to 2.0 in.), select PN40 (Process connection code : AD4) because there is no difference in the dimensions of the mating faces.
Even when DIN PN10 is required for a model of size 65 to 150 mm (2.5 to 6.0 in.), select PN16 (Process connection code : AD2) because there is no difference in the dimensions of the mating faces.
- *2: Mating dimensions are based on standards as follow:
ANSI:ASME B 16.5, DIN: DIN 2501, JIS:JIS B 2220 and JIS G 3443-2
- *3: AXF standard lay length dimension for ceramics linings are the same as those for ADMAG ceramics linings.
- *4: N shall be always selected for remote flowtubes
In the case of an integral flowmeter, select from among the figures at the right:
- *5: For explosion proof types, specify types of explosion proof certification using the optional codes. In case of TIIS flameproof type, the remote flowtube is available only for combined use with the AXFA14. For the TIIS flameproof type with wiring using a flameproof packing adapter, select optional code G12 or G11. Available only for JIS G1/2 female electrical connections.
- *6: For explosion proof types, JIS G1/2 female electrical connection is available only for TIIS flameproof type.
- *7: In case of integral flowmeters of the TIIS flameproof type, select "with indicator"(code 1 or 2).
- *8: Δ Users must consider the characteristics of selected wetted parts material and influence of process fluids.
The use of inappropriate materials can result in the leakage of corrosive process fluids and cause injury to personnel and/or damage to plant facilities. It is also possible that the instrument itself can be damaged and that fragments from the instrument can contaminate the user's process fluids.
Be very careful with highly corrosive process fluids such as hydrochloric acid, sulfuric acid, hydrogen sulfide, sodium hypochlorite, and high-temperature steam (150°C [302°F] or above). Contact Yokogawa for detailed information of the wetted parts material.
- *9: For FOUNDATION Fieldbus protocol, refer to GS 01E20F02-01E
- *10: For PROFIBUS PA protocol, refer to GS 01E20F12-01E.
- *11: Allowable fluid pressure should also be limited according to fluid temperature and pressure.
- *12: In the case of calibration code C in remote type, please order a combination of flowtube and converter.

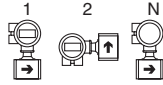

AXF STANDARD (Flange Type)

General-purpose Use/Submersible Type/Explosion proof Type, PFA/Polyurethane Rubber /Natural Soft Rubber/EPDM Rubber Lining

Model	Suffix Code	Description	Applicable Model	
AXF002	Size 2.5 mm (0.1 in.) Integral Flowmeter/Remote Flowtube		
AXF005	Size 5 mm (0.2 in.) Integral Flowmeter/Remote Flowtube		
AXF010	Size 10 mm (0.4 in.) Integral Flowmeter/Remote Flowtube		
AXF015	Size 15 mm (0.5 in.) Integral Flowmeter/Remote Flowtube		
AXF025	Size 25 mm (1.0 in.) Integral Flowmeter/Remote Flowtube		
AXF032	Size 32 mm (1.25 in.) Integral Flowmeter/Remote Flowtube		
AXF040	Size 40 mm (1.5 in.) Integral Flowmeter/Remote Flowtube		
AXF050	Size 50 mm (2.0 in.) Integral Flowmeter/Remote Flowtube		
AXF065	Size 65 mm (2.5 in.) Integral Flowmeter/Remote Flowtube		
AXF080	Size 80 mm (3.0 in.) Integral Flowmeter/Remote Flowtube		
AXF100	Size 100 mm (4.0 in.) Integral Flowmeter/Remote Flowtube		
AXF125	Size 125 mm (5.0 in.) Integral Flowmeter/Remote Flowtube		
AXF150	Size 150 mm (6.0 in.) Integral Flowmeter/Remote Flowtube		
AXF200	Size 200 mm (8.0 in.) Integral Flowmeter/Remote Flowtube		
AXF250	Size 250 mm (10 in.) Integral Flowmeter/Remote Flowtube		
AXF300	Size 300 mm (12 in.) Integral Flowmeter/Remote Flowtube		
AXF350	Size 350 mm (14 in.) Integral Flowmeter/Remote Flowtube		
AXF400	Size 400 mm (16 in.) Integral Flowmeter/Remote Flowtube		
Use	G	General-Purpose Use		
	W	Submersible Type	Size 15 mm (0.5 in.) to 400 mm (16 in.), Remote Flowtube only	
	C	Explosion proof Type (*6)	PFA lining only	
Converter Output Signal and Communication	-D	Integral Flowmeter with 4 to 20 mA DC Output and BRAIN Communication		
	-E	Integral Flowmeter with 4 to 20 mA DC Output and HART Communication		
	-F	Integral Flowmeter with Digital communication (FOUNDATION Fieldbus protocol) (*10)		
	-G	Integral Flowmeter with Digital communication (PROFIBUS PA protocol) (*11)		
	-N	Remote Flowtube for Combined Use with AXFA11		
	-P	Remote Flowtube for Combined Use with AXFA14		
Power Supply	1	Integral Flowmeter, 100 V to 240 V AC or 100 to 120 V DC		
	2	Integral Flowmeter, 24 V AC/DC		
	N	Remote Flowtube		
Lining (*9)	A	Fluorocarbon PFA		
	U	Polyurethane Rubber	Size 25 mm (1.0 in.) to 400 mm (16 in.)	
	D	Natural Soft Rubber	Size 50 mm (2.0 in.) to 400 mm (16 in.)	
	G	EPDM Rubber	Size 50 mm (2.0 in.) to 400 mm (16 in.)	
Electrode Material (*9)	L	JIS SUS316L (AISI 316L SS/EN 1.4404 Equivalent)		
	P	Platinum-iridium	PFA lining only	
	H	Hastelloy C276 Equivalent		
	T	Tantalum	PFA lining only	
	V	Titanium		
	W	Tungsten Carbide	Size 15 mm (0.5 in.) to 400 mm (16 in.), PFA/Polyurethane Rubber lining only	
Electrode Structure	1	Non-replaceable		
	2	Replaceable	General-Purpose use, Size 25 mm (1.0 in.) to 400 mm (16 in.) PFA/Polyurethane Rubber lining only Electrode Material: JIS SUS316L only	
Grounding Ring and Grounding Electrode Material (*9)	N	None		
	S	JIS SUS316 (AISI 316 SS/EN 1.4401 Equivalent)		
	L	JIS SUS316L (AISI 316L SS/EN 1.4404 Equivalent)		
	P	Platinum-iridium	Size 2.5 mm (0.1 in.) to 200 mm (8.0 in.), PFA lining only	
	H	Hastelloy C276 Equivalent		
	T	Tantalum	Size 2.5mm (0.1 in.) to 200 mm (8.0 in.), PFA lining only	
Process Connection (*4)(*12)	-BA1	ANSI Class 150 Flange (Stainless Steel)(*1)	Size 2.5 mm (0.1 in.) to 400 mm (16 in.)	
	-BA2	ANSI Class 300 Flange (Stainless Steel)(*1)	Size 2.5 mm (0.1 in.) to 300 mm (12 in.)	
	-BD1	DIN PN 10 Flange (Stainless Steel)(*2)	Size 200 mm (8.0 in.) to 400 mm (16 in.)	
	-BD2	DIN PN 16 Flange (Stainless Steel)(*2)	Size 65 mm (2.5 in.) to 300 mm (12 in.)	
	-BD4	DIN PN 40 Flange (Stainless Steel)(*1)(*2)	Size 2.5 mm (0.1 in.) to 50 mm (2.0 in.)	
	-BJ1	JIS 10K Flange (Stainless Steel)(*1)	Size 2.5 mm (0.1 in.) to 400 mm (16 in.)	
	-BJ2	JIS 20K Flange (Stainless Steel)(*1)	Size 2.5 mm (0.1 in.) to 300 mm (12 in.)	
	-BG1	JIS F12 (JIS75M) Flange (Stainless Steel)	Size 80 mm (3.0 in.) to 400 mm (16 in.)	
	-CA1	ANSI Class 150 Flange (Carbon Steel)	Size 50 mm (2 in.) to 400 mm (16 in.), Not available for TIIS flameproof type.	
	-CA2	ANSI Class 300 Flange (Carbon Steel)	Size 50 mm (2 in.) to 300 mm (12 in.), Not available for TIIS flameproof type.	
	-CD1	DIN PN 10 Flange (Carbon Steel)(*2)	Size 200 mm (8.0 in.) to 400 mm (16 in.), Not available for TIIS flameproof type.	
	-CD2	DIN PN 16 Flange (Carbon Steel)(*2)	Size 65 mm (2.5 in.) to 300 mm (12 in.), Not available for TIIS flameproof type.	
	-CD4	DIN PN 40 Flange (Carbon Steel)(*2)	Size 50 mm (2.0 in.) only, Not available for TIIS flameproof type.	
	-CJ1	JIS 10K Flange (Carbon Steel)	Size 50 mm (2.0 in.) to 400 mm (16 in.), Not available for TIIS flameproof type.	
	-CJ2	JIS 20K Flange (Carbon Steel)	Size 50 mm (2.0 in.) to 300 mm (12 in.), Not available for TIIS flameproof type.	
	-CG1	JIS F12 (JIS75M) Flange (Carbon Steel)	Size 80 mm (3.0 in.) to 400 mm (16 in.), Not available for TIIS flameproof type.	
	-DD4	DIN PN 40 Flange (Stainless Steel), DN10(*2)(*3)	Size 2.5 mm (0.1 in.) to 10 mm (0.4 in.)	
	-DJ1	JIS 10K Flange (Stainless Steel), 10 mm Diameter Nominal (*3)	Size 2.5 mm (0.1 in.) to 10 mm (0.4 in.)	
	-DJ2	JIS 20K Flange (Stainless Steel), 10 mm Diameter Nominal (*3)	Size 2.5 mm (0.1 in.) to 10 mm (0.4 in.)	
	Lay Length	1	Standard	
	Electrical Connection (*7)	-0	JIS G1/2 female	
		-2	ANSI 1/2 NPT female	Not available for Submersible Type
		-4	ISO M20×1.5 female	Not available for Submersible Type
	Indicator (*5)(*8)	1	Integral Flowmeter with indicator (Horizontal)	
2		Integral Flowmeter with indicator (Vertical)		
N		Integral Flowmeter without indicator /Remote Flowtube		
Calibration	B	Standard		
	C	High Grade (*13)	Size 25 mm (1.0 in.) to 200 mm (8.0 in.),PFA lining only	
Option	<input type="checkbox"/>	Optional code (See the Table of Optional Specifications)		

T17.EPS

- *1: For a flange type of 2.5 to 10 mm (0.1 to 0.4 in.), prepare 15 mm (0.5 in.) diameter nominal flanges on the process pipe side.
(Process connection codes: BA1, BA2, BD4, BJ1, and BJ2)
- *2: Even when DIN PN10 or 16 is required for a model of size 2.5 to 50 mm (0.1 to 2.0 in.), select PN40 (Process connection codes: BD4, CD4 and DD4) because there is no difference in the dimensions of the mating faces.
Even when DIN PN10 is required for a model of size 65 to 150 mm (2.5 to 6.0 in.), select PN16 (Process connection codes: BD2, CD2) because there is no difference in the dimensions of the mating faces.
- *3: For a flange type of 2.5 to 10 mm (0.1 to 0.4 in.)(Process connection codes: DJ1, DJ2, and DD4), prepare 10 mm (0.4 in.) diameter nominal flanges on the process pipe side.
- *4: Mating dimensions are based on standards as follow:
ANSI:ASME B 16.5, DIN: DIN 2501, JIS:JIS B 2220 and JIS G 3443-2
- *5: N shall be always selected for remote flowtubes
In the case of an integral flowmeter, select from among the figures at the right:
- *6: For explosion proof types, specify types of explosion proof certification using the optional codes. In case of TIIS flameproof type, the remote flowtube is available only for combined use with the AXFA14. For the TIIS flameproof type with wiring using a flameproof packing adapter, select optional code G12 or G11. Available only for JIS G1/2 female electrical connections.
- *7: For explosion proof types, JIS G1/2 female electrical connection is available only for TIIS flameproof type.
- *8: In case of integral flowmeters of the TIIS flameproof type, select "with indicator"(code 1 or 2).
- *9: Δ Users must consider the characteristics of selected wetted parts material and influence of process fluids.
The use of inappropriate materials can result in the leakage of corrosive process fluids and cause injury to personnel and/or damage to plant facilities. It is also possible that the instrument itself can be damaged and that fragments from the instrument can contaminate the user's process fluids.
Be very careful with highly corrosive process fluids such as hydrochloric acid, sulfuric acid, hydrogen sulfide, sodium hypochlorite, and high-temperature steam (150°C [302°F] or above).
Contact Yokogawa for detailed information of the wetted parts material.
- *10: For FOUNDATION Fieldbus protocol, refer to GS 01E20F02-01E
- *11: For PROFIBUS PA protocol, refer to GS 01E20F12-01E.
- *12: Allowable fluid pressure should also be limited according to fluid temperature and pressure.
- *13: In the case of calibration code C in remote type, please order a combination of flowtube and converter.

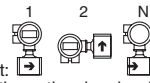

AXF STANDARD (Clamp/Union/Butt Weld Connection)
Sanitary Type , PFA Lining

Model	Suffix Code	Description	Applicable Model
AXF015	Size 15 mm (0.5 in.), Integral Flowmeter/Remote Flowtube	
AXF025	Size 25 mm (1.0 in.), Integral Flowmeter/Remote Flowtube	
AXF032	Size 32 mm (1.25 in.), Integral Flowmeter/Remote Flowtube	
AXF040	Size 40 mm (1.5 in.), Integral Flowmeter/Remote Flowtube	
AXF050	Size 50 mm (2.0 in.), Integral Flowmeter/Remote Flowtube	
AXF065	Size 65 mm (2.5 in.), Integral Flowmeter/Remote Flowtube	
AXF080	Size 80 mm (3.0 in.), Integral Flowmeter/Remote Flowtube	
AXF100	Size 100 mm (4.0 in.), Integral Flowmeter/Remote Flowtube	
AXF125	Size 125 mm (5.0 in.), Integral Flowmeter/Remote Flowtube	
Use	H	Sanitary Type	
Converter	-D	Integral Flowmeter with 4 to 20 mA DC Output and BRAIN Communication	
Output Signal	-E	Integral Flowmeter with 4 to 20 mA DC Output and HART Communication	
and	-F	Integral Flowmeter with Digital communication	
Communication	-G	Integral Flowmeter with Digital communication (FOUNDATION Fieldbus protocol) (*5)	
	-N	Integral Flowmeter with Digital communication (PROFIBUS PA protocol) (*6)	
	-P	Remote Flowtube for Combined use with AXFA11	
	-P	Remote Flowtube for Combined use with AXFA14	
Power Supply	1	Integral Flowmeter, 100 V to 240 V AC or 100 to 120 V DC	
	2	Integral Flowmeter, 24 V AC/DC	
	N	Remote Flowtube	
Lining (*4)	A	Fluorocarbon PFA	
Electrode Material (*4)	L	JIS SUS316L (AISI 316L SS/EN 1.4404 Equivalent)	
Electrode Structure	1	Non-replaceable	
Grounding Ring	N	None	
Process Connection (*2) (*4) (*7)	-HAB	Tri-Clamp (3A), JIS SUS316L or SUSF316L (AISI 316L SS/EN1.4404 Equivalent or ANSI F316L SS/EN 1.4435 Equivalent)(*1)	Size 15 mm (0.5 in.) to 100 mm (4.0in.), except 32 mm (1.25 in.)
	-HDB	DIN32676 Clamp, JIS SUS316L or SUSF316L (AISI 316L SS/EN1.4404 Equivalent or ANSI F316L SS/EN 1.4435 Equivalent)	Size 15 mm (0.5 in.) to 125 mm (5.0 in.)
	-HKB	ISO2852/SMS3016 Clamp, JIS SUS316L or SUSF316L (AISI 316L SS/EN1.4404 Equivalent or ANSI F316L SS/EN 1.4435 Equivalent)	Size 15 mm (0.5 in.) to 125 mm (5.0 in.)
	-JDB	DIN11851 Union, JIS SUS316L or SUSF316L (AISI 316L SS/EN1.4404 Equivalent or ANSI F316L SS/EN 1.4435 Equivalent)	Size 15 mm (0.5 in.) to 125 mm (5.0 in.)
	-JKB	ISO2853 Union, JIS SUS316L or SUSF316L (AISI 316L SS/EN1.4404 Equivalent or ANSI F316L SS/EN 1.4435 Equivalent)	Size 15 mm (0.5 in.) to 100 mm (4.0 in.)
	-JSB	SMS1145 Union, JIS SUS316L or SUSF316L (AISI 316L SS/EN1.4404 Equivalent or ANSI F316L SS/EN 1.4435 Equivalent)	Size 25 mm (1.0 in.) to 100 mm (4.0 in.)
	-KDB	Butt Weld for DIN 11850 Pipe Connection, JIS SUS316L or SUSF316L (AISI 316L SS/EN1.4404 Equivalent or ANSI F316L SS/EN 1.4435 Equivalent)	Size 15 mm (0.5 in.) to 125 mm (5.0 in.)
	-KKB	Butt Weld for ISO 2037 Pipe Connection, JIS SUS316L or SUSF316L (AISI 316L SS/EN1.4404 Equivalent or ANSI F316L SS/EN 1.4435 Equivalent)	Size 15 mm (0.5 in.) to 125 mm (5.0 in.)
Lay Length	1	Standard	
Electrical Connection	-0	JIS G1/2 female	
	-2	ANSI 1/2 NPT female	
	-4	ISO M20×1.5 female	
Indicator (*3)	1	Integral Flowmeter with indicator (Horizontal)	
	2	Integral Flowmeter with indicator (Vertical)	
	N	Integral Flowmeter without indicator /Remote Flowtube	
Calibration	B	Standard	
	C	High Grade (*8)	Size 25 mm (1.0 in.) to 125 mm (5.0 in.)
Option	<input type="checkbox"/>	Optional code (See the Table of Optional Specifications)	

*1: For a tri-clamp type of size 15 mm (0.5 in.)(Process connection code: HAB), prepare a 3/4 in. tri-clamp on the process pipe side. T18.EPS
 *2: The detail dimensions of process connections (clamp/union/butt weld) are shown in the 'EXTERNAL DIMENSIONS' section of the sanitary type. In case of Butt Weld type, ferrules, sleeves, or alternative must be provided by the user. User need to weld these parts to the butt weld adapter.
 *3: N shall be always selected for remote flowtubes. In the case of an integral flowmeter, select from among the following figures.

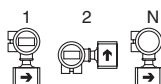

*4: Users must consider the characteristics of selected wetted parts material and influence of process fluids. The use of inappropriate materials can result in the leakage of corrosive process fluids and cause injury to personnel and/or damage to plant facilities. It is also possible that the instrument itself can be damaged and that fragments from the instrument can contaminate the user's process fluids. Be very careful with highly corrosive process fluids such as hydrochloric acid, sulfuric acid, hydrogen sulfide, sodium hypochlorite, and high-temperature steam (150°C [302°F] or above). Contact Yokogawa for detailed information of the wetted parts material.
 *5: For FOUNDATION Fieldbus protocol, refer to GS 01E20F02-01E
 *6: For PROFIBUS PA protocol, refer to GS 01E20F12-01E.
 *7: Allowable fluid pressure should also be limited according to fluid temperature and pressure.
 *8: In the case of calibration code C in remote type, please order a combination of flowtube and converter.

REPLACEMENT MODEL FOR EARLIER ADMAG OR ADMAG AE (Wafer Type)
General-purpose Use/Submersible Type/Explosion proof Type, PFA/Polyurethane Rubber Lining
 For the Wafer Types of size 250 mm (10 in.), 300 mm (12 in.), **AXF Standard** shall be selected.

Model	Suffix Code	Description	Applicable Model
AXF002	Size 2.5 mm (0.1 in.) Integral Flowmeter/Remote Flowtube (*8)	
AXF005	Size 5 mm (0.2 in.) Integral Flowmeter/Remote Flowtube (*8)	
AXF010	Size 10 mm (0.4 in.) Integral Flowmeter/Remote Flowtube (*8)	
AXF015	Size 15 mm (0.5 in.) Integral Flowmeter/Remote Flowtube (*8)	
AXF025	Size 25 mm (1.0 in.) Integral Flowmeter/Remote Flowtube	
AXF040	Size 40 mm (1.5 in.) Integral Flowmeter/Remote Flowtube	
AXF050	Size 50 mm (2.0 in.) Integral Flowmeter/Remote Flowtube	
AXF080	Size 80 mm (3.0 in.) Integral Flowmeter/Remote Flowtube	
AXF100	Size 100 mm (4.0 in.) Integral Flowmeter/Remote Flowtube	
AXF150	Size 150 mm (6.0 in.) Integral Flowmeter/Remote Flowtube	
AXF200	Size 200 mm (8.0 in.) Integral Flowmeter/Remote Flowtube	
Use	G	General-Purpose Use	Size 15 mm (0.5 in.) to 200 mm (8.0 in.), Remote Flowtube only PFA lining only
	W	Submersible Type	
	C	Explosion proof Type (*5)	
Converter Output Signal and Communication	-D	Integral Flowmeter with 4 to 20 mA DC Output and BRAIN Communication	
	-E	Integral Flowmeter with 4 to 20 mA DC Output and HART Communication	
	-F	Integral Flowmeter with Digital communication (FOUNDATION Fieldbus protocol) (*10)	
	-G	Integral Flowmeter with Digital communication (PROFIBUS PA protocol) (*11)	
	-N	Remote Flowtube for Combined Use with AXFA11	
-P	Remote Flowtube for Combined Use with AXFA14		
Power Supply	1	Integral Flowmeter, 100 V to 240 V AC or 100 to 120 V DC	
	2	Integral Flowmeter, 24 V AC/DC	
	N	Remote Flowtube	
Lining (*9)	A	Fluorocarbon PFA	Size 25 mm (1.0 in.) to 200 mm (8.0 in.)
	U	Polyurethane Rubber	
Electrode Material (*9)	L	JIS SUS316L (AISI 316L SS/EN 1.4404 Equivalent)	PFA lining only
	P	Platinum-iridium	
	H	Hastelloy C276 Equivalent	PFA lining only
	T	Tantalum	
	V	Titanium	
W	Tungsten Carbide	Size 15 mm (0.5 in.) to 200 mm (8.0 in.)	
Electrode Structure	1	Non-replaceable	
Grounding Ring and Grounding Electrode Material (*9)	N	None	Size 25 mm (1.0 in.) to 200 mm (8.0 in.)(*5)
	S	JIS SUS316 (AISI 316 SS/EN 1.4401 Equivalent)	
	L	JIS SUS316L (AISI 316L SS/EN 1.4404 Equivalent)	
	P	Platinum-iridium (*8)	
	H	Hastelloy C276 Equivalent	
T	Tantalum (*8)	PFA lining only	
V	Titanium		
Process Connection (*3)(*12)	-AA1	ANSI Class 150 Wafer(*1)	Size 2.5 mm (0.1 in.) to 200 mm (8.0 in.)
	-AA2	ANSI Class 300 Wafer(*1)	Size 2.5 mm (0.1 in.) to 200 mm (8.0 in.)
	-AD1	DIN PN 10 Wafer(*2)	Size 200 mm(8.0 in.) only
	-AD2	DIN PN 16 Wafer(*2)	Size 80 mm (3.0 in.) to 200 mm (8.0 in.)
	-AD4	DIN PN 40 Wafer(*1)(*2)	Size 2.5 mm (0.1 in.) to 50 mm (2.0 in.)
	-AJ1	JIS 10K Wafer(*1)	Size 2.5 mm (0.1 in.) to 200 mm (8.0 in.)
	-AJ2	JIS 20K Wafer(*1)	Size 2.5 mm (0.1 in.) to 200 mm (8.0 in.)
-AG1	JIS F12 (JIS75M) Wafer	Size 80 mm (3.0 in.) to 200 mm (8.0 in.)	
Lay Length	2	Matches an Earlier ADMAG Flowmeter (ADMAG or ADMAG AE) for Replacement	
Electrical Connection (*6)	-0	JIS G1/2 female	Not available for Submersible Type Not available for Submersible Type
	-2	ANSI 1/2 NPT female	
	-4	ISO M20×1.5 female	
Indicator (*4)(*7)	1	Integral Flowmeter with indicator(Horizontal)	
	2	Integral Flowmeter with indicator(Vertical)	
	N	Integral Flowmeter without indicator /Remote Flowtube	
Calibration	B	Standard	
Option	<input type="checkbox"/>	Optional code (See the Table of Optional Specifications)	

T19.EPS

- *1: For a wafer type of 2.5 to 10 mm (0.1 to 0.4 in.), prepare 15 mm (0.5 in.) diameter nominal flanges on the process pipe side.
(Process connection codes: AA1, AA2, AD4, AJ1, and AJ2)
- *2: Even when DIN PN10 or 16 is required for a model of size 2.5 to 50 mm (0.1 to 2.0 in.), select PN40 (Process connection code: AD4) because there is no difference in the dimensions of the mating faces.
Even when DIN PN10 is required for a model of size 65 to 150 mm (2.5 to 6.0 in.), select PN16 (Process connection code: AD2) because there is no difference in the dimensions of the mating faces.
- *3: Mating dimensions are based on standards as follow:
ANSI:ASME B 16.5, DIN: DIN 2501, JIS:JIS B 2220 and JIS G 3443-2
- *4: N shall be always selected for remote flowtubes
In the case of an integral flowmeter, select from among the figures at the right:
- *5: For explosion proof types, specify types of explosion proof certification using the optional codes. In case of TIIS flameproof type, the remote flowtube is available only for combined use with the AXFA14. For the TIIS flameproof type with wiring using a flameproof packing adapter, select optional code G12 or G11. Available only for JIS G1/2 female electrical connections.
- *6: For explosion proof types, JIS G1/2 female electrical connection is available only for TIIS flameproof type.
- *7: In case of integral flowmeters of the TIIS flameproof type, select "with indicator"(code 1 or 2).
- *8: In case of platinum-iridium (grounding ring code P) or tantalum (grounding ring code T) or None (grounding ring code N) in wafer type of 2.5 mm (0.1 in.) to 15 mm (0.5 in.), the lay lengths of Replacement model are the same as those for AXF Standard.
In this case, AXF Standard shall be selected.
- *9: **△**Users must consider the characteristics of selected wetted parts material and influence of process fluids.
The use of inappropriate materials can result in the leakage of corrosive process fluids and cause injury to personnel and/or damage to plant facilities. It is also possible that the instrument itself can be damaged and that fragments from the instrument can contaminate the user's process fluids.
Be very careful with highly corrosive process fluids such as hydrochloric acid, sulfuric acid, hydrogen sulfide, sodium hypochlorite, and high-temperature steam (150°C [302°F] or above). Contact Yokogawa for detailed information of the wetted parts material.
- *10: For FOUNDATION Fieldbus protocol, refer to GS 01E20F02-01E
- *11: For PROFIBUS PA protocol, refer to GS 01E20F12-01E.
- *12: Allowable fluid pressure should also be limited according to fluid temperature and pressure.

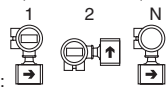

REPLACEMENT MODEL FOR EARLIER ADMAG OR ADMAG AE (Flange Type)

General-purpose Use/Submersible Type/Explosion proof Type, PFA/Polyurethane Rubber Lining

For Flange Types of size 15 mm (0.5 in.) to 100 mm (4.0 in.), 300 mm (12 in.) to 400 mm (16 in.), **AXF Standard** shall be selected.

Model	Suffix Code	Description	Applicable Model
AXF150	Size 150 mm (6.0 in.) Integral Flowmeter/Remote Flowtube	
AXF200	Size 200 mm (8.0 in.) Integral Flowmeter/Remote Flowtube	
AXF250	Size 250 mm (10 in.) Integral Flowmeter/Remote Flowtube	
Use	G	General-Purpose Use	
	W	Submersible Type	Remote Flowtube only
	C	Explosion proof Type (*4)	PFA lining only
Converter Output Signal and Communication	-D	Integral Flowmeter with 4 to 20 mA DC Output and BRAIN Communication	
	-E	Integral Flowmeter with 4 to 20 mA DC Output and HART Communication	
	-F	Integral Flowmeter with Digital communication (FOUNDATION Fieldbus protocol) (*8)	
	-G	Integral Flowmeter with Digital communication (PROFIBUS PA protocol) (*9)	
	-N	Remote Flowtube for Combined Use with AXFA11	
	-P	Remote Flowtube for Combined Use with AXFA14	
Power Supply	1	Integral Flowmeter, 100 V to 240 V AC or 100 to 120 V DC	
	2	Integral Flowmeter, 24 V AC/DC	
	N	Remote Flowtube	
Lining (*7)	A	Fluorocarbon PFA	
	U	Polyurethane Rubber	
Electrode Material (*7)	L	JIS SUS316L (AISI 316L SS/EN 1.4404 Equivalent)	
	P	Platinum-iridium	PFA lining only
	H	Hastelloy C276 Equivalent	
	T	Tantalum	PFA lining only
	V	Titanium	
	W	Tungsten Carbide	
Electrode Structure	1	Non-replaceable	
	2	Replaceable	General-Purpose use, Electrode Material : JIS SUS316L only
Grounding Ring and Grounding Electrode Material (*7)	N	None	
	S	JIS SUS316 (AISI 316 SS/EN 1.4401 Equivalent)	
	L	JIS SUS316L (AISI 316L SS/EN 1.4404 Equivalent)	
	P	Platinum-iridium	Size 150 mm (6.0 in.), 200 mm (8.0 in.), PFA lining only
	H	Hastelloy C276 Equivalent	
	T	Tantalum	Size 150 mm (6.0 in.), 200 mm (8.0 in.), PFA lining only
Process Connection (*2)(*10)	-CA1	ANSI Class 150 Flange (Carbon Steel)	Size 150 mm (6.0 in.) to 250 mm (10 in.), Not available for TIIS flameproof type.
	-CA2	ANSI Class 300 Flange (Carbon Steel)	Size 150 mm (6.0 in.) to 250 mm (10 in.), Not available for TIIS flameproof type.
	-CD1	DIN PN 10 Flange (Carbon Steel)(*1)	Size 200 mm (8.0 in.) to 250 mm (10 in.), Not available for TIIS flameproof type.
	-CD2	DIN PN 16 Flange (Carbon Steel)(*1)	Size 150 mm (6.0 in.) to 250 mm (10 in.), Not available for TIIS flameproof type.
	-CJ1	JIS 10K Flange (Carbon Steel)	Size 150 mm (6.0 in.) to 250 mm (10 in.), Not available for TIIS flameproof type.
	-CJ2	JIS 20K Flange (Carbon Steel)	Size 150 mm (6.0 in.) to 250 mm (10 in.), Not available for TIIS flameproof type.
	-CG1	JIS F12 (JIS75M) Flange (Carbon Steel)	Size 150 mm (6.0 in.) to 250 mm (10 in.), Not available for TIIS flameproof type.
Lay Length	2	Matches an Earlier ADMAG Flowmeter (ADMAG or ADMAG AE) for Replacement	
Electrical Connection (*5)	-0	JIS G1/2 female	
	-2	ANSI 1/2 NPT female	Not available for Submersible Type
	-4	ISO M20×1.5 female	Not available for Submersible Type
Indicator (*3)(*6)	1	Integral Flowmeter with indicator (Horizontal)	
	2	Integral Flowmeter with indicator (Vertical)	
	N	Integral Flowmeter without indicator /Remote Flowtube	
Calibration	B	Standard	
Option	<input type="checkbox"/>	Optional code (See the Table of Optional Specifications)	

T20.EPS

*1: Even when DIN PN10 is required for a 150 (6.0 in.)-mm model, select PN16 (Process connection code: CD2) because there is no difference in the dimensions of the mating faces.

*2: Mating dimensions are based on standards as follow:
ANSI: ASME B 16.5, DIN:DIN 2501, JIS:JIS B 2220 and JIS G 3443-2

*3: N shall be always selected for remote flowtubes.
In the case of an integral, select from among the following figures:

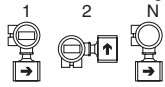

*4: For explosion proof types, specify types of explosion proof certification using the optional codes. In case of TIS flameproof type, the remote flowtube is available only for combined use with the AXFA14. For the TIS flameproof type with wiring using a flameproof packing adapter, select optional code G12 or G11. Available only for JIS G1/2 female electrical connections.

*5: For explosion proof types, JIS G1/2 female electrical connection is available only for TIS flameproof type.

*6: In case of integral flowmeters of the TIS flameproof type, select "with indicator"(code 1 or 2).

*7: Δ Users must consider the characteristics of selected wetted parts material and influence of process fluids.

The use of inappropriate materials can result in the leakage of corrosive process fluids and cause injury to personnel and/or damage to plant facilities. It is also possible that the instrument itself can be damaged and that fragments from the instrument can contaminate the user's process fluids.

Be very careful with highly corrosive process fluids such as hydrochloric acid, sulfuric acid, hydrogen sulfide, sodium hypochlorite, and high-temperature steam (150°C [302°F] or above). Contact Yokogawa for detailed information of the wetted parts material.

*8: For FOUNDATION Fieldbus protocol, refer to GS 01E20F02-01E

*9: For PROFIBUS PA protocol, refer to GS 01E20F12-01E.

*10: Allowable fluid pressure should also be limited according to fluid temperature and pressure.

OPTIONAL SPECIFICATIONS FOR FLOWTUBES

Table of Optional Specifications “◇”

○: Available -: Not available

Item	Specifications	Applicable Model						Code	
		General		Explosion proof		Submersible	Sanitary		
		Integral Flowmeter	Remote Flowtube	Integral Flowmeter	Remote Flowtube	Remote Flowtube	Integral Flowmeter		Remote Flowtube
		□ W L G	□ N P	□ W L G	□ N P	□ N P	□ W L G		□ N P
		AXF**G	AXF**G-P	AXF**C	AXF**C-P	AXF**W-P	AXF**H	AXF**H-P	
For District Heating and Cooling or Condensation-proof	Urethane resin potting is applied in the terminal box of a remote flowtube. Select JIS G1/2 for the electrical connections. 30-meter signal and excitation cables are pre-wired and waterproof grounds with union joints are attached at factory.	-	○	-	-	-	-	○	DHC
User-specified Signal and Excitation Cable Length	Available for the submersible type and a model with optional code DHC. The cable length is limited up to 200 meters when combined with an AXFA11 converter, or 100 meters when combined with an AXFA14 converter. Following "L," specify the cable length in three digits as a multiple of 1 meter (e.g., 001, 002, or 005) for a length up to 5 meters, or as a multiple of 5 meters (i.e., 005, 010, 015, or the like) for a length of 5 meters or more. If this optional code is not selected, a 30-meter length cable is attached.	-	○	-	-	○	-	○	L***
Lightning Protector	A lightning protector is built into the power terminals.	○	-	○	-	-	○	-	A
DC Noise Cut Circuit	The DC Noise Cut Circuit is built in. Available for 15 mm (0.5 in.) and larger sizes, and for fluids with the conductivity of 50 μS/cm or higher. Nullifies the empty check and electrode adhesion diagnostic function.	○	-	○	-	-	○	-	ELC
Burn Out Down (*9)	The output level is set to 0 mA during a CPU failure and is set 2.4 mA (-10 %) or less during an alarm. Standard products are delivered with a setting 25 mA during a CPU failure and 21.6 mA (110%) or more during an alarm.	○	-	○	-	-	○	-	C1
NAMUR NE43 Compliance (*9)	Output signal limits: 3.8 to 20.5 mA	○	-	○	-	-	○	-	C2
	Failure alarm down-scale: The output level is set to 0 mA during a CPU failure and is set 2.4 mA (-10%) or less during an alarm. Failure alarm up-scale: The output level is set to 25 mA during a CPU failure and is set 21.6 mA (110%) or more during an alarm.	○	-	○	-	-	○	-	C3
Active Pulse Output (*9)	Active pulses are output in order to drive an external electromagnetic or electronic counter directly using the converter's internal power supply. (Nullifies the standard transistor contact pulse output.) Output voltage: 24 V DC ±20% Pulse specifications: • The drive current of 150 mA or less • Pulse rate: 0.0001 to 2 pps (pulse/second); Pulse width: 20, 33, 50, or 100 ms	○	-	○	-	-	○	-	EM
Mass Unit Setting	The flow rate span, transmission pulse weight, and totalizer display pulse weight can be set in terms of mass unit. Specify the density of the process fluid when ordering in addition to the mass flow rate span, transmission pulse weight (for mass unit), and totalizer display pulse weight (for mass unit). When ordering a remote flowtube, parameters for 'Mass Unit Setting' will be set in the corresponding converter before shipment. 1. Density a. Available density Numerics: Specify the numeric within the value of 500 to 2000 kg/m ³ , 4.2 to 16.7 lb/gal, or 31.2 to 124.8 lb/cf. And it can be up to five digits, to a maximum of 32000 ignoring the decimal point. A fraction is limited to the fourth decimal place. b. Available density units: kg/m ³ , lb/gal, lb/cf Example: A water density is about 1000kg/m ³ . In this case specify "1000kg/m ³ ". However a density is changed by temperature. Specify the actual density. (The 1000kg/m ³ is equivalent to 8.345lb/gal and 62.43lb/cf.) 2. The mass flow rate span, transmission pulse weight, and totalizer display pulse weight a. Available density Numerics: Specify the numeric within the value of 0.0001 to 32000. And it can be up to five digits, to a maximum of 32000 ignoring the decimal point. A fraction is limited to the fourth decimal place. b. Mass Units Available mass units: t, kg, g, klb, lb Available time units: /d, /h, /min, /s Note1: In case of specifying the mass flow span, calculate the volumetric flow span by the setting density, and specify the available value in the mass flow span. Note2: In case of transmission pulse weight and totalizer display pulse weight, specify the mass unit which was specified as the flow unit.	○	○	○	○	○	○	○	MU

T26-1.EPS

● Table of Optional Specifications (continued)

○: Available -: Not available

Item	Specifications	Applicable Model							Code	
		General		Explosion proof		Submersible	Sanitary			
		Integral Flowmeter	Remote Flowtube	Integral Flowmeter	Remote Flowtube	Remote Flowtube	Integral Flowmeter	Remote Flowtube		
		□ W L □ G	○ W L □ G	□ W L □ C	○ W L □ C	○ W L □	□ W L □	○ W L □		
G3/4 Female Waterproof Glands	Waterproof glands for G3/4 conduits or flexible tubes are attached to the electrical connections. Available only for JIS G1/2 female electric connections.	-	○	-	-	-	-	○	EW	
Waterproof Glands	Waterproof glands are attached to the electrical connections. Available only for JIS G1/2 female electric connections.	○	○	-	-	-	○	○	EG	
Waterproof Glands with Union Joints	Waterproof glands with union joints are attached to the electrical connections. Available only for JIS G1/2 female electric connections.	○	○	-	-	-	○	○	EU	
Plastic Glands	Plastic glands are attached to the electrical connections. Available only for JIS G1/2 female electric connections.	○	○	-	-	-	○	○	EP	
Mirror Finished PFA Lining	Mirror finishing on the PFA lining inside of the tube to the smoothness lining. Available for 15 mm (0.5 in.) and larger sizes. The Ra is average of measured values on several point. Size 15 to 200 mm (0.5 to 8.0 in.) : Ra 0.05 to 0.15 μm Size 250 to 400 mm (10 to 16 in.) : Ra 0.05 to 0.25 μm	○	○	○	○	○	○	○	PM	
Mirror Finished Ceramics	Mirror finishing on the inside of the ceramics tube to Ra ≤ 0.1 μm. Available for 5 mm (0.2 in.) and larger sizes. The Ra is average of measured values on several point.	○	○	○	○	-	-	-	CM	
Stainless Steel Tag Plate	A pendant tag plate of JIS SUS304 (AISI 304 SS/EN 1.4301 equivalent) is provided. Choose this option when a pendant tag plate is required in addition to the standard name plate with the tag number inscribed on it. Dimension (Height × Width): Appr. 12.5 (4.92) × 40 (15.7) mm (inch)	○	○	○	○	○	○	○	SCT	
Direction change of the electrical connection (*1)	+90 degrees rotated converter (or terminal box) to change the direction of the electrical connection.	○	○	○	○	○	○	○	RA	
	+180 degrees rotated converter (or terminal box) to change the direction of the electrical connection.	○	○	○	○	○	○	○	RB	
	-90 degrees rotated converter (or terminal box) to change the direction of the electrical connection.	○	○	○	○	○	○	○	RC	
Bolts, Nuts, and Gaskets (*2)	Bolts, nuts, and gaskets are provided for wafer connections. Available only for ANSI 150, JIS10K, or, JIS20K wafer connections.	Bolts and nuts: Carbon steel; Gaskets: Chloroprene rubber (*3)	○	○	○	○	○	-	-	BCC
		Bolts and nuts: Carbon steel; Gaskets: PTFE-sheathed non-asbestos (*4)	○	○	○	○	○	-	-	BCF
		Bolts: JIS SUS304 (AISI 304 SS stainless steel equivalent); Nuts: JIS SUS403 (AISI 403SS stainless steel equivalent) ; Gaskets: Chloroprene rubber (*3)	○	○	○	○	○	-	-	BSC
		Bolts: JIS SUS304 (AISI 304 SS stainless steel equivalent); Nuts: JIS SUS403 (AISI 403SS stainless steel equivalent) ; Gaskets: PTFE-sheathed non-asbestos (*4)	○	○	○	○	○	-	-	BSF
Special Gaskets (*5) (*10)	Viton® gaskets for use with a PFA or ceramics lining with PVC piping. Allowable temperature and pressure are equivalent to Valqua #4010, special fluororubber not mixed. Available for 2.5 mm (0.1 in.) to 200 mm (8.0 in.) of PFA lining or 15 to 200 mm (0.5 to 8 in.) sizes of ceramics lining.	○	○	○	○	○	-	-	GA	
	Acid-resistant Viton® gaskets for use with a PFA or ceramics lining with PVC piping. Allowable temperature and pressure are equivalent to Valqua #4010, special fluororubber mixed (mixing #D2470). Available for 2.5 mm (0.1 in.) to 200 mm (8.0 in.) of PFA lining or 15 to 200 mm (0.5 to 8 in.) sizes of ceramics lining.	○	○	○	○	○	-	-	GC	
	Alkali-resistant Viton® gaskets for use with a PFA or ceramics lining with PVC piping. Allowable temperature and pressure are equivalent to Valqua #4010, special fluororubber mixed (mixing #RCD970). Available for 2.5 mm (0.1 in.) to 200 mm (8.0 in.) of PFA lining or 15 to 200 mm (0.5 to 8 in.) sizes of ceramics lining.	○	○	○	○	○	-	-	GD	
	Alkali-resistant carbonized fluororesin gaskets for use with a ceramics lining with metal piping. Allowable temperature and pressure are equivalent to Valqua #7026.	○	○	○	○	-	-	-	GF	
	Silicon rubber gaskets for Sanitary Type, provided between the lining and the adapter. For the condition of fluid temp. 120 to 160 C (248 to 320 F).	-	-	-	-	-	○	○	GH	

T26-2.EPS

● Table of Optional Specifications (continued)

○: Available -: Not available

Item	Specifications	Applicable Model							Code
		General		Explosion proof		Submersible	Sanitary		
		Integral Flowmeter	Remote Flowtube	Integral Flowmeter	Remote Flowtube	Remote Flowtube	Integral Flowmeter	Remote Flowtube	
		AXF***G	AXF***G-NP	AXF***C	AXF***C-NP	AXF***W-NP	AXF***H	AXF***H-NP	
Oil-prohibited Use	Electrodes, linings, grounding rings/grounding electrodes, gaskets and adapters (for sanitary type) are assembled and packed with polyethylene after being cleaned with water and acetone and dried with air. The label 'OIL FREE' is affixed.	○	○	○	○	-	○	○	K1
Oil-prohibited Use with Dehydrating Treatment	Electrodes, linings, and grounding rings are assembled and packed with polyethylene including desiccants after being cleaned with water and acetone and dried with air. The label 'OIL & WATER FREE' is affixed.	○	○	○	○	-	-	-	K5
Painting Color Change	Coated in black (Munsell N1.5 or its equivalent.)	○	○	○	○	-	○	○	P1
	Coated in jade green (Munsell 7.5 BG 4/1.5 or its equivalent.)	○	○	○	○	-	○	○	P2
	Coated in metallic silver.	○	○	○	○	-	○	○	P7
Epoxy Resin Coating	Epoxy resin coating which has alkali-resistance instead of standard polyurethane resin coating. The color is same as standard type.	○	○	○	○	-	-	-	X1
High Anti-corrosion Coating	Three-layer coating (polyurethane coating on two-layer epoxy resin coating) in the same range as that for the standard coating. The color is same as standard type. Salt/alkali/acid/weather-resistance.	○	○	○	○	-	-	-	X2
Calibration Certificate	Level 2: The Declaration and the Calibration Equipment List are issued.	○	○	○	○	○	○	○	L2
	Level 3: The Declaration and the Primary Standard List are issued.	○	○	○	○	○	○	○	L3
	Level 4: The Declaration and the Yokogawa Measuring Instruments Control System are issued.	○	○	○	○	○	○	○	L4
Material Certificate	Reproduced material certificate for : PFA/polyurethane: Pipe, electrodes, grounding rings or grounding electrodes, flanges or mini flanges, adapters (for sanitary type)	○	○	○	○	○	○	○	M01
	Ceramics: only grounding rings or grounding electrodes or union joint	○	○	○	○	○	○	○	E01
	E01: Material Certificate with cover according to EN10204 3.1								
Hydrostatic Test	The test verifies the absence of leaks by applying the following water pressures (which are determined under process connection conditions) to linings for ten minutes. Test results are described in the Note column of a test certificate (QIC). Process Connection: ANSI Class 150, DIN PN10, JIS 10K ANSI Class 300, DIN PN16, JIS 20K DIN PN40, Union joint (Ceramics lining) JIS F12 Water Pressure: 1.5 MPa 3.0 MPa 6.0 MPa 1.25 MPa	○	○	○	○	○	-	-	T01
Withstand Voltage Test Certificate (*11) (*12)	The test verifies the withstand voltage by applying the following conditions for remote flowtube of General-purpose use or Submersible type. (For remote flowtube of Explosion proof type, this test is performed as standard.) Test results are described in a test certificate (QIC). WT1: Between excitation current terminal and ground terminal, 1000V AC for 1 minute	-	○	-	-	○	-	-	WT1
	WT2: Between excitation current terminal and ground terminal, and between signal terminals and excitation current terminal, 1500V AC for 1 minute	-	○	-	-	○	-	-	WT2
PMI Test Certificate (*13) (*14) (*15)	Positive Material Identification test certificate of three major chemical components (Nickel, Chromium and Molybdenum) for specified materials.	○	○	○	○	○	-	-	PM1
	PM1: grounding rings	○	○	○	○	○	-	-	PM2
	PM2: grounding rings, and flanges or mini flanges PM3: grounding rings, flanges or mini flanges, and pipe	○	○	○	○	○	-	-	PM3
Liquid Penetration Test Certificate (*16)	Liquid penetration test certificate for the welded part of flanges or mini flanges.	○	○	○	○	○	○	○	PT
Vent Hole	With a vent hole provided for permeable fluids (such as nitric acid, hydrofluoric acid, or sodium hydroxide at high temperature). Available only for a PFA lining flange type.	○	○	○	○	-	-	-	H

T26-3.EPS









● Table of Optional Specifications (continued)

○: Available -: Not available

Item	Specifications	Applicable Model							Code		
		General		Explosion proof		Submersible	Sanitary				
		Integral Flowmeter	Remote Flowtube	Integral Flowmeter	Remote Flowtube	Remote Flowtube	Integral Flowmeter	Remote Flowtube			
		□ωL□G	Z□	□ωL□□	Z□□	Z□□	□ωL□□	Z□□			
Enhanced Dual Frequency Excitation (*6)	Available for 25 to 200 mm (1.0 to 8.0 in.) sizes. Products are delivered with the Standard dual frequency excitation mode and the Enhanced dual frequency excitation mode enabled. Although the meter factors for the Standard dual frequency excitation mode and the Enhanced dual frequency excitation mode are inscribed on the name plate, the flow calibration of optional code HF1 is not performed in Enhanced dual frequency excitation. Excitation mode select optional code HF2 when an accurate flow measurement is required.	○	○	○	○	○	○	○	○	HF1	
	Available for 25 to 200 mm (1.0 to 8.0 in.) sizes. Products are delivered with the Standard dual frequency excitation mode and the Enhanced dual frequency excitation mode enabled. The meter factor for the Enhanced dual frequency excitation obtained by flow calibration is inscribed on the name plate and set into the combined converter in addition to the meter factor for the Standard dual frequency excitation.	○	○	○	○	○	○	○	○	○	HF2
Five-point Calibration in User-specified Span	A flow test near 0, 25, 50, 75, and 100% of the user-specified span is performed instead of the flow test of the standard 2m/s span and a test certificate (QIC) is submitted. Specify the span (100% flow span) whose corresponding flow velocity lies between 0.5 to 10 m/s (0.8 to 10 m/s for sizes 32, 65, and 125 mm) and that is less than the maximum line capacity. Selectable range of flow rate span is showing below. Size : mm Selectable range of flow rate span : m³/h (in.) (Flow rate span velocity : m/s) 2.5 (0.1) 0.009 (0.5) to 0.05 (2.83) 5 (0.2) 0.036 (0.5) to 0.2 (2.83) 10 (0.4) 0.15 (0.5) to 0.96 (3.40) 15 (0.5) 0.32 (0.5) to 2.8 (4.40) 25 (1) 0.89 (0.5) to 11 (6.22) 32 (1.25) 2.32 (0.8) to 28.9 (10.00) 40 (1.5) 2.27 (0.5) to 28.0 (6.30) 50 (2) 3.54 (0.5) to 56 (7.92) 65 (2.5) 9.56 (0.8) to 80 (6.70) 80 (3) 9.05 (0.5) to 126 (6.96) 100 (4) 14.2 (0.5) to 190 (6.72) 125 (5) 35.3 (0.8) to 300 (6.79) 150 (6) 31.9 (0.5) to 380 (5.97) 200 (8) 56.6 (0.5) to 670 (5.92) 250 (10) 88.4 (0.5) to 1000 (5.66) 300 (12) 128 (0.5) to 1200 (4.72) 350 (14) 174 (0.5) to 1200 (3.47) 400 (16) 227 (0.5) to 1350 (2.98)	○	○	○	○	○	○	○	○	○	SC
FM Approval	FM Explosion proof See "HAZARDOUS AREA CLASSIFICATION"	-	-	○	○	-	-	-	-	FF1	
ATEX Certification	ATEX Explosion proof See "HAZARDOUS AREA CLASSIFICATION"	-	-	○	○	-	-	-	-	KF2	
CSA Certification	CSA Explosion proof, Dual Seal See "HAZARDOUS AREA CLASSIFICATION"	-	-	○	○	-	-	-	-	CF1	
IECEX Certification	IECEX Explosion proof See "HAZARDOUS AREA CLASSIFICATION"	-	-	○	○	-	-	-	-	SF2	
TIIS Certification	TIIS Flameproof See "HAZARDOUS AREA CLASSIFICATION"	-	-	○	△ (*8)	-	-	-	-	JF3	
Flameproof packing adapter for TIIS Flameproof Type (*7)	Two flameproof packing adapters	-	-	○	○	-	-	-	-	G12	
	One flameproof packing adapter and a blanking plug. Available for integral flowmeter and only when a four-wire cable is used for power input and signal output with a 24V power supply.	-	-	○ (*9)	-	-	-	-	-	G11	

T26-4.EPS

● Table of Optional Specifications (continued)

	Standard	+90-degree rotation	+180-degree rotation	-90-degree rotation
		Optional Code RA	Optional Code RB	Optional Code RC
Integral Flowmeter	Electrical Connection 	Indicator 	Indicator  Electrical Connection	Indicator 
Remote Flowtube		Electrical Connection 		Electrical Connection 

*2: When specifying the optional code BCC or BSC for a PFA or ceramics lining, it is advisable to specify the optional code GA, GC, or GD at the same time to prevent potential leakage caused by the difference in elasticity between the flowtube and chloroprene gaskets. Refer to description of "Gasket" in the "Wetted Part Material".

*3: Allowable temperature and pressure with the optional code BCC or BSC (only for Gaskets:Chloroprene rubber) are equivalent to Valqua #2010.

*4: Allowable temperature and pressure with the optional code BCF or BSF (only for Gaskets:PTFE-sheathed non-asbestos) are equivalent to Valqua #7030 (S).

*5: Special gaskets are inserted between the flowtube and the grounding ring or grounding electrode.

*6: Enhanced dual frequency excitation is not available for models with calibration code C (High Grade Accuracy).

*7: Select optional code G12 or G11 when TIIS Flameproof type with wiring using a flameproof packing adapter. Available only for JIS G1/2 female electric connection.

*8: The TIIS flameproof type is only available for AXF**C-P (remote flowtube for combined use with AXFA14).

*9: In the case of Fieldbus communication type, optional codes C1, C2, C3, EM and G11 are not available.

*10: In the case of size 32 mm, optional code GH is not available.

*11: Neither optional code WT1 nor WT2 is available for models with lining material "Natural Soft Rubber" or "EPDM Rubber" (Lining code: D or G).

*12: Either optional code WT1 or WT2 can be selected.

*13: In case of sanitary type or union joint type with ceramics lining, optional code PM1, PM2 or PM3 is not available as they have no grounding rings.

*14: In case of carbon steel flanges or mini flanges, the amount of Nickel, Chromium and Molybdenum in the carbon steel are not stipulated and optional code PM2 or PM3 is not available. For material specifications, refer to description of "Flowtube Material".

*15: Only one code from PM1, PM2 or PM3 can be selected.

*16: In case of no welded portion, optional code PT is not available. For available sizes, refer to the following table.

Use	Process Connection	Size
General-purpose Use Submersible Type Explosion proof Type	Wafer	25 to 300 mm (1.0 to 12 in.) Note: Not available for size 25 mm (1.0 in.) with lay length of AXF Standard (Lay Length code: 1)
	Flange	25 to 400mm (0.1 to 16 in.)
Sanitary Type	Clamp/Union/Butt Weld Connection	32 to 125 mm (1.25 to 5.0 in.)

T26-4_1.EPS

EXTERNAL DIMENSIONS

● AXF Standard, AXF002-AXF015, Wafer Type, PFA Lining

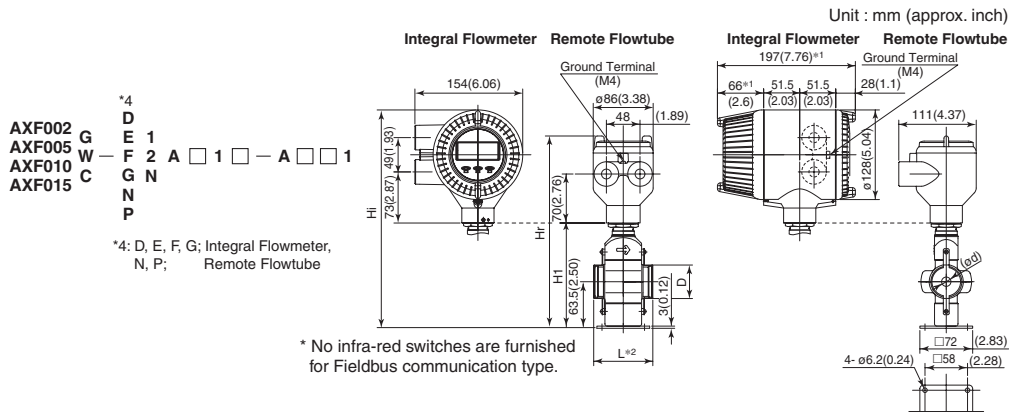

Model	Size code	002	005	010	015
	Size	2.5(0.1)	5(0.2)	10(0.4)	15(0.5)
	Lining code	A	A	A	A
Remote flowtube	Face-to-face length	81(3.19)			
	Outside dia.	D			
Integral flowmeter	Inger diameter of Grounding ring	od			
	Height	H1			
Remote flowtube	Max. Height	Hr			
	Weight kg (lb) *3	2.4(5.3)			
Integral flowmeter	Max. Height	Hi			
	Weight kg (lb)	4.1(9.0)			

- *1: When indicator code N is selected, subtract 12 mm (0.47 inch) from the value in the figure. In case of explosion proof type with indicator, add 5 mm (0.2 inch) to it.
- *2: Depending on the selection of grounding ring code and optional code, add the following value to L (face-to-face length).

Option Code	Grounding Ring Code	S, L, H, V	P, T	N
	None	+0	+26(1.02)	-2(0.08)
	GA, GC, GD (Special Gaskets)	+6(0.24)	+28(1.10)	-

- *3: When submersible type or option code DHC is selected, waterproof glands and a 30m long cable are attached. Add 9.5kg(20.9lb) to the weight in the table.

F22.EPS

● AXF Standard, AXF025-AXF125, Wafer Type, PFA /Polyurethane Rubber /Natural Soft Rubber /EPDM Rubber Lining

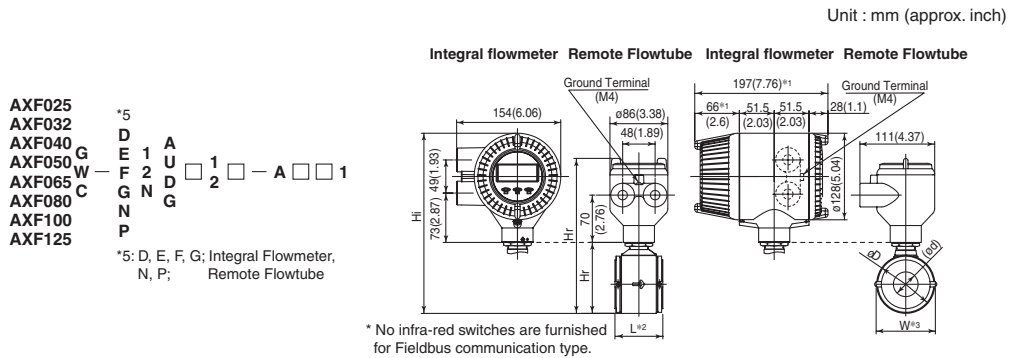

Model	Size code	025	032	040	050	065	080	100	125
	Size	25(1)	32(1.25)	40(1.5)	50(2)	65(2.5)	80(3)	100(4)	125(5)
	Lining code	A,U	A,U	A,U	A,U D,G	A,U D,G	A,U D,G	A,U D,G	A,U D,G
Remote Flowtube	Face-to-face length	L *2							
	Outside dia.	øD							
Integral Flowmeter	Inger diameter of Grounding ring	od							
	Width	W *3							
Remote Flowtube	Max. Height	Hr							
	Weight kg (lb) *4								
Integral Flowmeter	Max. Height	Hi							
	Weight kg (lb)								

- *1: When indicator code N is selected, subtract 12 mm (0.47 inch) from the value in the figure. In case of explosion proof type with indicator, add 5 mm (0.2 inch) to it.
- *2: Depending on the selection of grounding ring code and optional code, add the following value to L (face-to-face length).

Option Code	Grounding Ring Code	S, L, H, V	P, T	N
	None	+0	+26(1.02)	-2(0.08)
	GA, GC, GD (Special Gaskets)	+8(0.31)	+30(1.18)	-

- *3: When electrode structure 2 is selected, add the following value to W (width).

Nominal Size	25	32, 40, 50	65, 80	100	125
W	+52.5(2.07)	+52(2.05)	+49(1.93)	+48(1.89)	+47(1.85)

- *4: When submersible type or option code DHC is selected, waterproof glands and a 30m long cable are attached. Add 9.5kg(20.9lb) to the weight in the table.

F23.EPS

● AXF Standard, AXF150-AXF300, Wafer Type, PFA /Polyurethane Rubber /Natural Soft Rubber /EPDM Rubber Lining

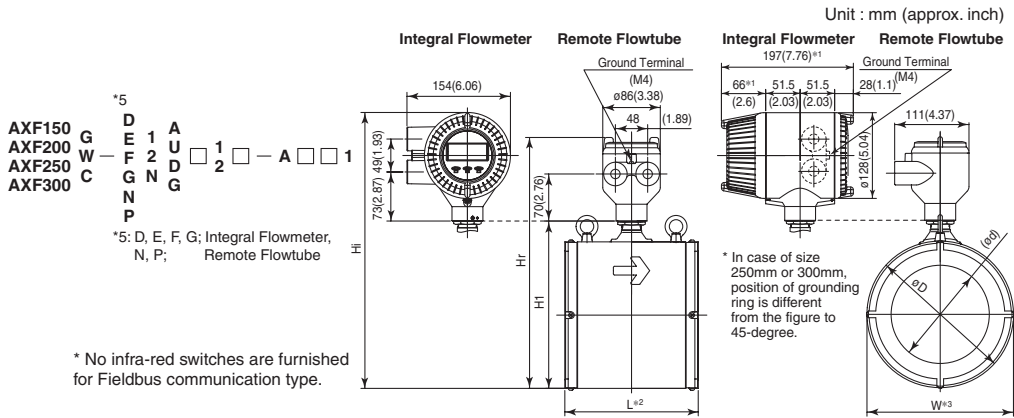

* No infra-red switches are furnished for Fieldbus communication type.

Model	Size code		150	200	250	300
	Size		150(6)	200(8)	250(10)	300(12)
Remote Flowtube	Lining code		A.U	A.U	A.U	A.U
			D.G	D.G	D.G	D.G
Remote Flowtube	Face-to-face length	L ^{*2}	200(7.87)	250(9.84)	300(11.81)	350(13.78)
	Outside dia.	ØD	202(7.95)	252(9.92)	310(12.20)	358(14.09)
Integral Flowmeter	Inner diameter of Grounding ring	Ød	146.1(5.75)	193.6(7.62)	243.7(9.59)	294.7(11.60)
	Width	W ^{*3}	202(7.95)	252(9.92)	310(12.20)	358(14.09)
Remote Flowtube	Max. Height	Hr	367(14.45)	417(16.42)	478(18.82)	526(20.71)
	Weight kg (lb) ^{*4}		14.5(32.0)	22.1(48.7)	39.0(86.0)	48.3(106.5)
Integral Flowmeter	Max. Height	Hi	405(15.93)	455(17.89)	516(20.31)	564(22.20)
	Weight kg (lb)		16.2(35.7)	23.8(52.4)	40.7(89.7)	50.0(110.2)

- *1: When indicator code N is selected, subtract 12 mm (0.47 inch) from the value in the figure. In case of explosion proof type with indicator, add 5 mm (0.2 inch) to it.
- *2: Depending on the selection of grounding ring code and optional code, add the following value to L (face-to-face length).

Nominal Size: 150 to 200mm				
Grounding Ring Code	S, L, H, V	P, T	N	
Option Code	None	+0	+32(1.26)	-2(0.08)
	GA, GC, GD (Special Gaskets)	+10(0.39)	+38(1.5)	-

Nominal Size: 250 to 300mm				
Grounding Ring Code	S, L, H, V	P, T	N	
Option Code is "None"	+0	-	-2(0.08)	

- *3: When electrode structure 2 is selected, add the following value to W(width).

Nominal size	150	200	250	300
W	+49(1.93)	+50(1.97)	+49(1.93)	+53(2.09)

- *4: When submersible type or option code DHC is selected, waterproof glands and a 30m long cable are attached. Add 9.5kg(20.9lb) to the weight in the table.

F24.EPS

● AXF Standard, AXF002-AXF010, Weld · Union Joint, Ceramics Lining

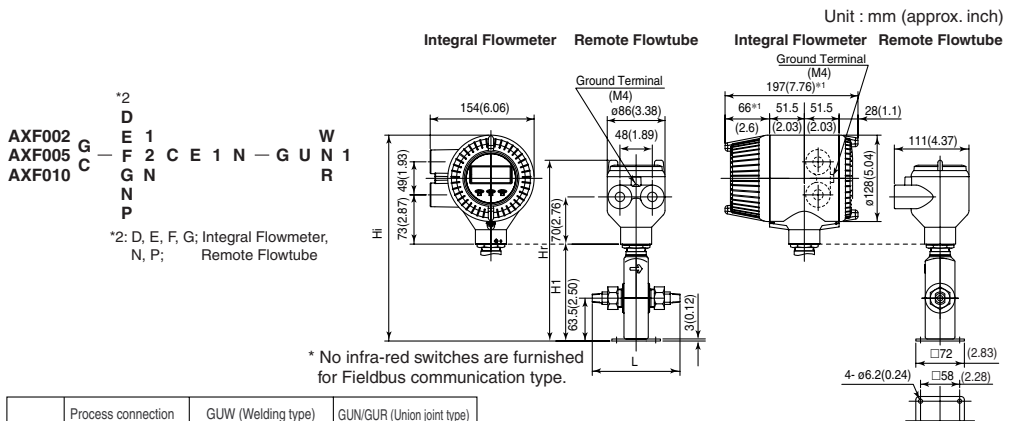

* No infra-red switches are furnished for Fieldbus communication type.

Model	Process connection		GUW (Welding type)			GUN/GUR (Union joint type)		
	Size code		002	005	010	002	005	010
	Size		2.5 (0.1)	5 (0.2)	10 (0.4)	2.5 (0.1)	5 (0.2)	10 (0.4)
Remote flowtube	Lining code		C	C	C	C	C	C
	Face-to-face length	L	140(5.51)			130(5.12)		
Integral flowmeter	Height	H1	144(5.67)			144(5.67)		
	Max. Height	Hr	268(10.55)			268(10.55)		
Remote flowtube	Weight kg (lb)		2.3(5.1)			2.3(5.1)		
	Max. Height	Hi	306(12.03)			306(12.03)		
Integral flowmeter	Weight kg (lb)		4(8.8)			4(8.8)		

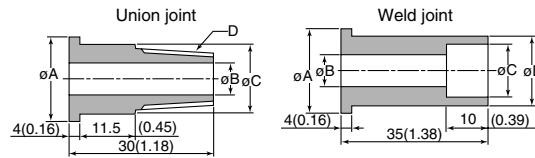

Size	ØA	ØB	ØC	D	Size	ØA	ØB	ØC	ØD
2.5 (0.1)	22(0.87)	8(0.31)	18.5(0.73)	R1/4	2.5(0.1)	22(0.87)	8(0.31)	14.3(0.56)	18.5(0.73)
5 (0.2)	22(0.87)	8(0.31)	18.5(0.73)	NPT1/4	5(0.2)	22(0.87)	8(0.31)	14.3(0.56)	18.5(0.73)
10 (0.4)	25(0.98)	10(0.39)	22.5(0.89)	R3/8	10(0.4)	25(0.98)	10(0.39)	17.8(0.70)	22.5(0.89)
	25(0.98)	10(0.39)	22.5(0.89)	NPT3/8					

- *1: When indicator code N is selected, subtract 12 mm (0.47 inch) from the value in the figure. In case of explosion proof type with indicator, add 5 mm (0.2 inch) to it.

F25.EPS

● AXF Standard, AXF015, Wafer Type, Ceramics Lining

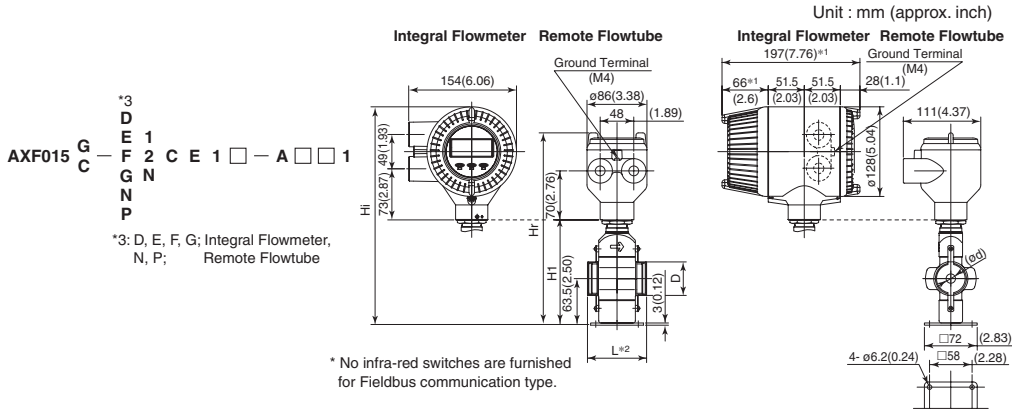

Model	Size code	015	
	Size	15(0.5)	
	Lining code	C	
Remote flowtube	Face-to-face length	L*2	85(3.35)
	Outside dia.	D	44(1.73)
Integral flowmeter	Inner diameter of Grounding ring	ød	15(0.59)
	Height	H1	144(5.67)
Remote flowtube	Max. Height	Hr	268(10.55)
	Weight kg (lb)		2.3(5.1)
Integral flowmeter	Max. Height	Hi	306(12.03)
	Weight kg (lb)		4(8.8)

*1: When indicator code N is selected, subtract 12 mm (0.47 inch) from the value in the figure. In case of explosion proof type with indicator, add 5 mm (0.2 inch) to it.

*2: Depending on the selection of grounding ring code and optional code, add the following value to L (face-to-face length).

Grounding Ring Code	S, L, H, V	P, T	N
L(Face-to-face length)	+0	+22(0.87)	-6(0.24)

F26.EPS

● AXF Standard, AXF025-AXF100, Wafer Type, Ceramics Lining

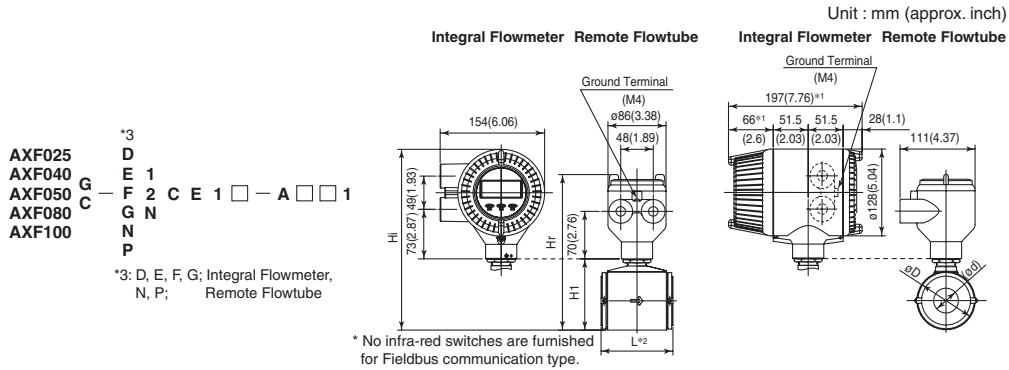

Model	Size code	025	040	050	080	100	
	Size	25(1)	40(1.5)	50(2)	80(3)	100(4)	
	Lining code	C	C	C	C	C	
Remote Flowtube	Face-to-face length	L*2	93(3.66)	106(4.17)	120(4.72)	160(6.30)	180(7.09)
	Outside dia.	øD	67.5(2.66)	86(3.39)	99(3.90)	129(5.08)	155(6.10)
Integral Flowmeter	Inner diameter of Grounding ring	ød	27(1.06)	40(1.57)	52(2.05)	81(3.19)	98(3.86)
	Height	H1	92(3.62)	111(4.37)	129(5.08)	159(6.26)	184(7.24)
Remote Flowtube	Max. Height	Hr	216(8.50)	235(9.25)	253(9.96)	283(11.14)	308(12.13)
	Weight kg (lb)		2.3(5.1)	3.2(7.0)	4.1(9.0)	6.8(15.0)	9.6(21.1)
Integral Flowmeter	Max. Height	Hi	254(9.98)	273(10.73)	291(11.44)	321(12.64)	346(13.62)
	Weight kg (lb)		4.0(8.8)	4.9(10.8)	5.8(12.7)	8.5(18.8)	11.3(24.9)

*1: When indicator code N is selected, subtract 12 mm (0.47 inch) from the value in the figure. In case of explosion proof type with indicator, add 5 mm (0.2 inch) to it.

*2: Depending on the selection of grounding ring code and optional code, add the following value to L (face-to-face length).

Grounding Ring Code	S, L, H, V	P, T	N
L(Face-to-face length)	+0	+22(0.87)	-6(0.24)

F27.EPS

● AXF Standard, AXF150, AXF200, Wafer Type, Ceramics Lining

AXF150 G — D E 1
 AXF200 C — F 2 C E 1 □ — A □ □ 1
 G N
 P

*3: D, E, F, G; Integral Flowmeter,
 N, P; Remote Flowtube

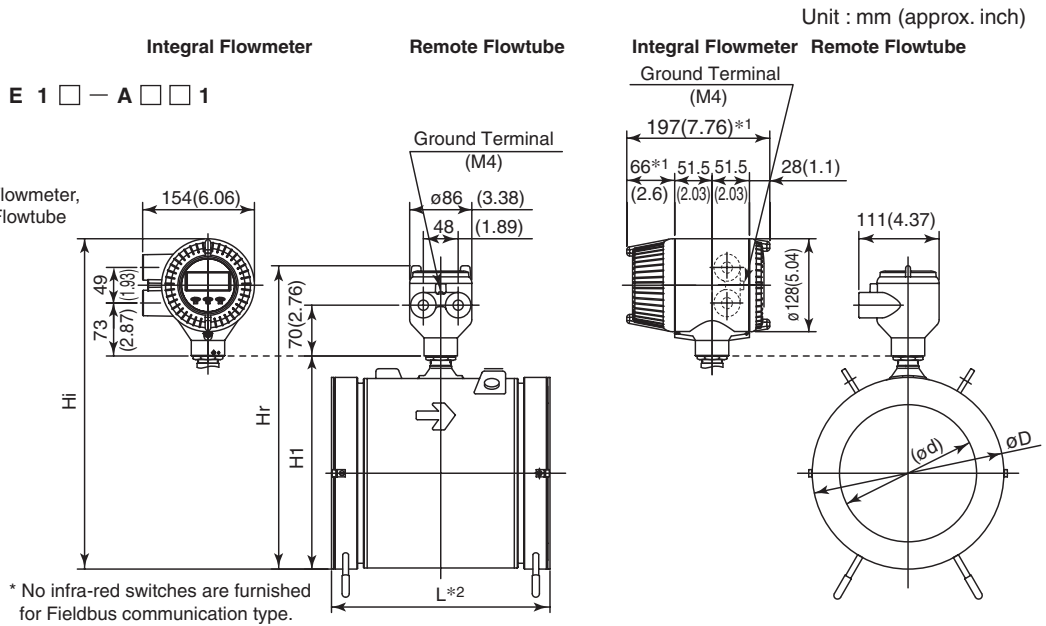

Model	Size code	150	200	
	Size	150(6)	200(8)	
	Lining code	C	C	
Remote Flowtube	Face-to-face length	L*2	232(9.13)	302(11.89)
	Outside dia.	D	214(8.43)	264(10.39)
Integral Flowmeter	Inner diameter of Grounding ring	∅d	144(5.67)	192(7.56)
	Height	H1	254(10.00)	304(11.97)
Remote Flowtube	Max. Height	Hr	378(14.88)	428(16.85)
	Weight kg (lb)		20.2(44.5)	33.5(73.9)
Integral Flowmeter	Max. Height	Hi	416(16.36)	466(18.33)
	Weight kg (lb)		21.9(48.3)	35.2(77.6)

*1: When indicator code N is selected, subtract 12 mm (0.47 inch) from the value in the figure.

In case of explosion proof type with indicator, add 5 mm (0.2 inch) to it.

*2: Depending on the selection of grounding ring code and optional code, add the following value to L (face-to-face length).

Grounding Ring Code	S, L, H, V	P, T	N
L(Face-to-face length)	+0	+30(1.18)	-6(0.24)

● AXF Standard, AXF002-AXF015, JIS/ANSI/DIN Flange Type, PFA Lininig

Unit : mm (approx. inch)

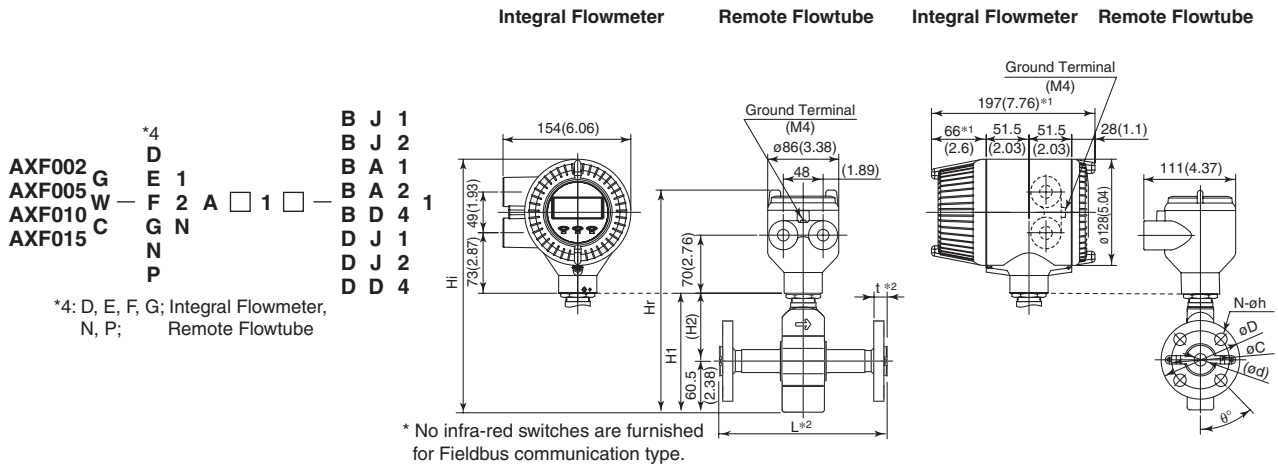

Model	Process Connection	BJ1(JIS10K)				BJ2(JIS20K)				BA1(ANSI Class 150)				BA2(ANSI Class 300)				BD4(DIN PN40)				DJ1(JIS10K)			DJ2(JIS20K)			DD4(DIN PN40)						
	Size code	002	005	010	015	002	005	010	015	002	005	010	015	002	005	010	015	002	005	010	015	002	005	010	002	005	010	002	005	010				
	Size	2.5 (0.1)	5 (0.2)	10 (0.4)	15 (0.5)	2.5 (0.1)	5 (0.2)	10 (0.4)	15 (0.5)	2.5 (0.1)	5 (0.2)	10 (0.4)	15 (0.5)	2.5 (0.1)	5 (0.2)	10 (0.4)	15 (0.5)	2.5 (0.1)	5 (0.2)	10 (0.4)	15 (0.5)	2.5 (0.1)	5 (0.2)	10 (0.4)	2.5 (0.1)	5 (0.2)	10 (0.4)	2.5 (0.1)	5 (0.2)	10 (0.4)				
	Lining code	A	A	A	A	A	A	A	A	A	A	A	A	A	A	A	A	A	A	A	A	A	A	A	A	A	A	A	A	A				
Remote Flowtube	Face-to-face length L _s ^{*2}	150(5.91)				200(7.87)				150(5.91)				200(7.87)				150(5.91)				200(7.87)				150(5.91)			150(5.91)			150(5.91)		
	Outside dia. øD	95(3.74)				95(3.74)				88.9(3.50)				95.3(3.75)				95(3.74)				90(3.54)			90(3.54)			90(3.54)						
	Thickness t ^{*2}	15(0.59)				15(0.59)				15(0.59)				15(0.59)				15(0.59)				12(0.47)			12(0.47)			12(0.47)						
	Inner diameter of Grounding ring ød	15(0.59)				15(0.59)				15(0.59)				15(0.59)				15(0.59)				12(0.47)			12(0.47)			12(0.47)						
Integral Flowmeter	Pitch circle dia. øC	70(2.76)				70(2.76)				60.5(2.38)				66.5(2.62)				65(2.56)				65(2.56)			65(2.56)			60(2.36)						
	Bolt hole interval ø°	45				45				45				45				45				45			45			45						
	Hole dia. øh	15(0.59)				15(0.59)				15.7(0.62)				15.7(0.62)				14(0.55)				15(0.59)			15(0.59)			14(0.55)						
	Number of holes N	4				4				4				4				4				4			4			4						
Remote Flowtube	Height H1	141(5.54)				141(5.54)				141(5.54)				141(5.54)				141(5.54)				141(5.54)			141(5.54)			141(5.54)						
	Height H2	80(3.15)				80(3.15)				80(3.15)				80(3.15)				80(3.15)				80(3.15)			80(3.15)			80(3.15)						
Integral Flowmeter	Max. Height Hr	265(10.43)				265(10.43)				265(10.43)				265(10.43)				265(10.43)				265(10.43)			265(10.43)			265(10.43)						
	Weight kg (lb) ^{*3}	3.4(7.5)				3.5(7.7)				3.6(7.9)				3.7(8.2)				3.6(7.9)				3.8(8.4)				3.3(7.3)			3.4(7.5)			3.6(7.9)		
Remote Flowtube	Max. Height Hi	303(11.91)				303(11.91)				303(11.91)				303(11.91)				303(11.91)				303(11.91)			303(11.91)			303(11.91)						
	Weight kg (lb)	5.1(11.2)				5.2(11.5)				5.3(11.7)				5.4(11.9)				5.3(11.7)				5.5(12.1)				5.0(11.0)			5.1(11.2)			5.3(11.7)		

- *1: When indicator code N is selected, subtract 12 mm (0.47 inch) from the value in the figure. In case of explosion proof type with indicator, add 5 mm (0.2 inch) to it.
- *2: Depending on the selection of grounding ring code and optional code, add the following value to "L" (face-to-face length) and "t" (thickness of flange).

Grounding Ring Code	L		t			
	S, L, H, V	P, T	N			
Option Code	None	+0	+0	+28(1.02)+13(0.51)	-2(0.08)	-1(0.04)
	GA, GC, GD (Special Gaskets)	+8(0.31)	+4(0.16)	+30(1.18)+15(0.59)	-	-

- *3: When submersible type or option code DHC is selected, waterproof glands and a 30m long cable are attached. Add 9.5kg(20.9lb) to the weight in the table.

F29.EPS

● AXF Standard, AXF025-AXF050, JIS/ANSI/DIN Flange Type, PFA /Polyurethane Rubber /Natural Soft Rubber /EPDM Rubber Lining

Unit : mm (approx. inch)

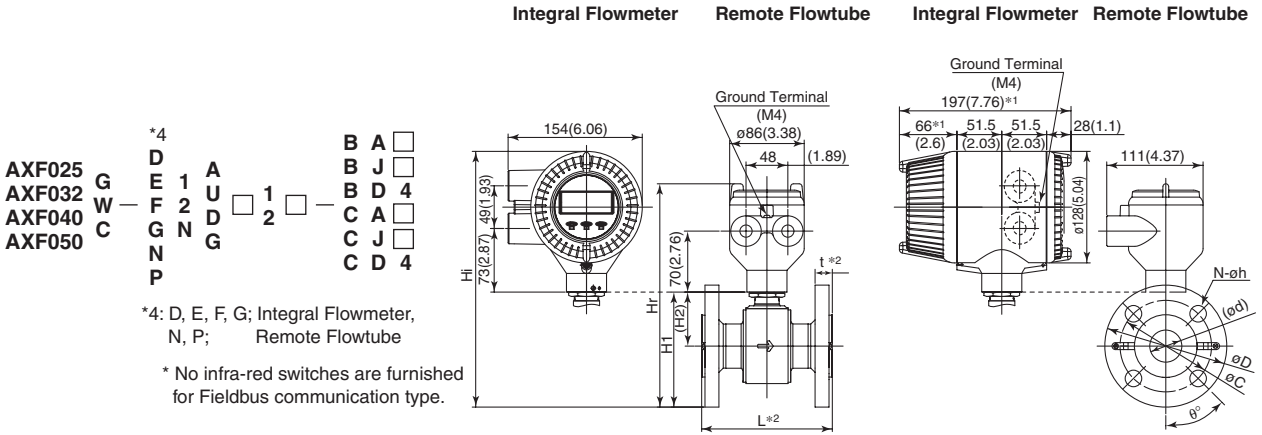

AXF025 G W C
 AXF032 D E F G N
 AXF040 A U D G
 AXF050 1 2

B A □
 B J □
 B D 4 □
 C C A □
 C J □
 C D 4 □

*4: D, E, F, G; Integral Flowmeter, N, P; Remote Flowtube

* No infra-red switches are furnished for Fieldbus communication type.

Model	Process Connection	BJ1(JIS10K)				BJ2(JIS20K)				BA1(ANSI Class 150)				BA2(ANSI Class 300)				BD4(DIN PN40)				BD4/CD4(DIN PN40)			
		025	032	040	050	025	032	040	050	025	032	040	050	025	032	040	050	025	032	040	050	025	032	040	050
	Size code	025	032	040	050	025	032	040	050	025	032	040	050	025	032	040	050	025	032	040	050	025	032	040	050
	Size	25 (1)	32 (1.25)	40 (1.5)	50 (2)	25 (1)	32 (1.25)	40 (1.5)	50 (2)	25 (1)	32 (1.25)	40 (1.5)	50 (2)	25 (1)	32 (1.25)	40 (1.5)	50 (2)	25 (1)	32 (1.25)	40 (1.5)	50 (2)	25 (1)	32 (1.25)	40 (1.5)	50 (2)
	Lining code	A.U	A.U	A.U	A.U	A.U	A.U	A.U	A.U	A.U	A.U	A.U	A.U	A.U	A.U	A.U	A.U	A.U	A.U	A.U	A.U	A.U	A.U	A.U	A.U
Remote Flowtube	Face-to-face length L ₃ ^{*2}	200 (7.87)	200 (7.87)	200 (7.87)	200 (7.87)	200 (7.87)	200 (7.87)	200 (7.87)	200 (7.87)	200 (7.87)	200 (7.87)	200 (7.87)	200 (7.87)	200 (7.87)	200 (7.87)	200 (7.87)	200 (7.87)	200 (7.87)	200 (7.87)	200 (7.87)	200 (7.87)	200 (7.87)	200 (7.87)	200 (7.87)	200 (7.87)
	Outside dia. øD	125 (4.92)	135 (5.31)	140 (5.51)	155 (6.10)	125 (4.92)	135 (5.31)	140 (5.51)	155 (6.10)	108.0 (4.25)	117.3 (4.62)	127.0 (5.00)	152.4 (6.00)	124.0 (4.88)	133.4 (5.25)	155.4 (6.12)	165.1 (6.50)	115 (4.53)	140 (5.51)	150 (5.91)	165 (6.50)	115 (4.53)	140 (5.51)	150 (5.91)	165 (6.50)
	Thickness t ^{*2}	18 (0.71)	20 (0.79)	20 (0.79)	20 (0.79)	20 (0.79)	20 (0.79)	22 (0.87)	22 (0.87)	18.2 (0.72)	19.7 (0.78)	21.5 (0.85)	23.1 (0.91)	21.5 (0.85)	23.1 (0.91)	24.6 (0.97)	26.4 (1.04)	22 (0.87)	22 (0.87)	22 (0.87)	24 (0.94)	22 (0.87)	22 (0.87)	22 (0.87)	24 (0.94)
	Inner diameter of Grounding ring ød	28 (1.10)	34 (1.34)	41 (1.61)	53 (2.09)	28 (1.10)	34 (1.34)	41 (1.61)	53 (2.09)	28 (1.10)	34 (1.34)	41 (1.61)	53 (2.09)	28 (1.10)	34 (1.34)	41 (1.61)	53 (2.09)	28 (1.10)	34 (1.34)	41 (1.61)	53 (2.09)	28 (1.10)	34 (1.34)	41 (1.61)	53 (2.09)
	Pitch circle dia. øC	90 (3.54)	100 (3.94)	105 (4.13)	120 (4.72)	90 (3.54)	100 (3.94)	105 (4.13)	120 (4.72)	79.2 (3.12)	88.9 (3.50)	98.6 (3.88)	120.7 (4.75)	88.9 (3.50)	98.6 (3.88)	114.3 (4.50)	127.0 (5.00)	85 (3.35)	100 (3.94)	110 (4.33)	125 (4.92)	85 (3.35)	100 (3.94)	110 (4.33)	125 (4.92)
	Bolt hole interval θ°	45	45	45	45	45	45	45	22.5	45	45	45	45	45	45	45	22.5	45	45	45	45	45	45	45	45
	Hole dia. øh	19 (0.75)	19 (0.75)	19 (0.75)	19 (0.75)	19 (0.75)	19 (0.75)	19 (0.75)	19 (0.75)	15.7 (0.62)	15.7 (0.62)	15.7 (0.62)	19.1 (0.75)	19.1 (0.75)	19.1 (0.75)	22.4 (0.88)	19.1 (0.75)	14 (0.55)	18 (0.71)	18 (0.71)	18 (0.71)	14 (0.55)	18 (0.71)	18 (0.71)	18 (0.71)
Integral Flowmeter	Number of holes N	4	4	4	4	4	4	4	8	4	4	4	4	4	4	4	8	4	4	4	4	4	4	4	4
	Height H1	120 (4.74)	129 (5.08)	138 (5.43)	157 (6.16)	120 (4.74)	129 (5.08)	138 (5.43)	157 (6.16)	112 (4.40)	120 (4.72)	131 (5.17)	155 (6.11)	120 (4.72)	128 (5.04)	146 (5.73)	162 (6.36)	115 (4.54)	131 (5.16)	143 (5.63)	162 (6.36)	115 (4.54)	131 (5.16)	143 (5.63)	162 (6.36)
	Height H2	58 (2.28)	61 (2.40)	68 (2.67)	79 (3.11)	58 (2.28)	61 (2.40)	68 (2.67)	79 (3.11)	58 (2.28)	61 (2.40)	68 (2.67)	79 (3.11)	58 (2.28)	61 (2.40)	68 (2.67)	79 (3.11)	58 (2.28)	61 (2.40)	68 (2.67)	79 (3.11)	58 (2.28)	61 (2.40)	68 (2.67)	79 (3.11)
Remote Flowtube	Max. Height Hr	244 (9.62)	253 (9.96)	262 (10.31)	281 (11.04)	244 (9.62)	253 (9.96)	262 (10.31)	281 (11.04)	236 (9.28)	244 (9.61)	255 (10.05)	279 (10.99)	244 (9.60)	252 (9.92)	270 (10.61)	286 (11.24)	239 (9.42)	255 (10.04)	267 (10.51)	286 (11.24)	239 (9.42)	255 (10.04)	267 (10.51)	286 (11.24)
	Weight kg (lb) ^{*3}	4.4 (9.8)	5.3 (11.7)	5.7 (12.6)	6.8 (14.9)	4.8 (10.5)	5.7 (12.6)	6.2 (13.6)	7.0 (15.4)	3.9 (8.5)	4.5 (9.9)	5.4 (11.9)	7.4 (16.4)	5.0 (11.0)	5.8 (12.9)	7.8 (17.1)	9.0 (19.8)	4.7 (10.4)	6.1 (13.4)	6.9 (15.2)	8.7 (19.2)	4.7 (10.4)	6.1 (13.4)	6.9 (15.2)	8.7 (19.2)
Integral Flowmeter	Max. Height Hi	282 (11.09)	291 (11.46)	299 (11.79)	318 (12.52)	282 (11.09)	291 (11.46)	299 (11.79)	318 (12.52)	273 (10.76)	282 (11.10)	293 (11.53)	317 (12.47)	281 (11.07)	290 (11.42)	307 (12.09)	323 (12.72)	277 (10.90)	293 (11.54)	304 (11.98)	323 (12.72)	277 (10.90)	293 (11.54)	304 (11.98)	323 (12.72)
	Weight kg (lb)	6.1 (13.5)	7.0 (15.5)	7.4 (16.4)	8.5 (18.6)	6.5 (14.3)	7.4 (16.4)	7.9 (17.4)	8.7 (19.1)	5.6 (12.2)	6.2 (13.6)	7.1 (15.7)	9.1 (20.1)	6.7 (14.7)	7.5 (16.6)	9.5 (20.8)	10.7 (23.6)	6.4 (14.1)	7.8 (17.2)	8.6 (19.0)	10.4 (22.9)	6.4 (14.1)	7.8 (17.2)	8.6 (19.0)	10.4 (22.9)

- *1: When indicator code N is selected, subtract 12 mm (0.47 inch) from the value in the figure. In case of explosion proof type with indicator, add 5 mm (0.2 inch) to it.
- *2: Depending on the selection of grounding ring code and optional code, add the following value to "L" (face-to-face length) and "t" (thickness of flange).

Grounding Ring Code	L		t				
	S, L, H, V	P, T	N	N			
Option Code	None	+0	+0	+26(1.02)	+13(0.51)	-2(0.08)	-1(0.04)
	GA, GC, GD (Special Gaskets)	+8(0.31)	+4(0.16)	+30(1.18)	+15(0.59)	-	-

- *3: When submersible type or option code DHC is selected, waterproof glands and a 30m long cable are attached. Add 9.5kg(20.9lb) to the weight in the table.

● AXF Standard, AXF065-AXF125, JIS/ANSI/DIN Flange Type, PFA /Polyurethane Rubber /Natural Soft Rubber /EPDM Rubber Lining

Unit : mm (approx. inch)

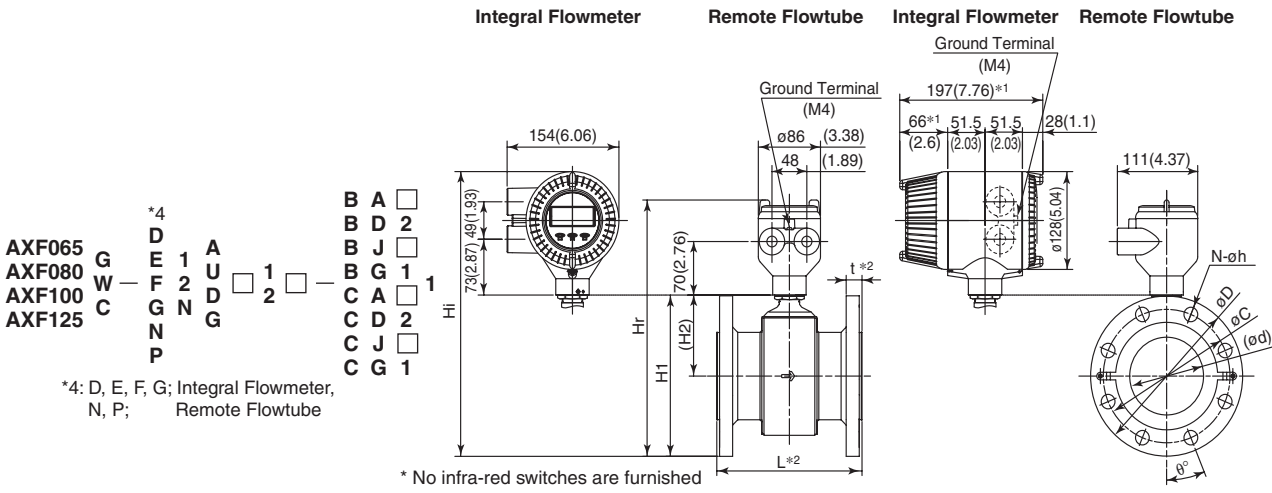

* No infra-red switches are furnished for Fieldbus communication type.

Model	Process Connection	BJ1/CJ1(JIS10K)				BJ2/CJ2(JIS20K)				BG1/CG1(JIS F12)				BA1/CA1(ANSI Class 150)				BA2/CA2(ANSI Class 300)				BD2/CD2(DIN PN16)						
		065	080	100	125	065	080	100	125	080	100	125	080	100	125	065	080	100	125	065	080	100	125	065	080	100	125	
	Size code	065	080	100	125	065	080	100	125	080	100	125	065	080	100	125	065	080	100	125	065	080	100	125	065	080	100	125
	Size	65 (2.5)	80 (3)	100 (4)	125 (5)	65 (2.5)	80 (3)	100 (4)	125 (5)	80 (3)	100 (4)	125 (5)	65 (2.5)	80 (3)	100 (4)	125 (5)	65 (2.5)	80 (3)	100 (4)	125 (5)	65 (2.5)	80 (3)	100 (4)	125 (5)	65 (2.5)	80 (3)	100 (4)	125 (5)
	Lining code	A.U	A.U	A.U	A.U	A.U	A.U	A.U	A.U	A.U	A.U	A.U	A.U	A.U	A.U	A.U	A.U	A.U	A.U	A.U	A.U	A.U	A.U	A.U	A.U	A.U	A.U	A.U
Remote flowtube	Face-to-face length L _s ^{*2}	200 (7.87)	200 (7.87)	250 (9.84)	250 (9.84)	200 (7.87)	200 (7.87)	250 (9.84)	250 (9.84)	200 (7.87)	200 (7.87)	250 (9.84)	200 (7.87)	200 (7.87)	250 (9.84)	250 (9.84)	200 (7.87)	200 (7.87)	250 (9.84)	250 (9.84)	200 (7.87)	200 (7.87)	250 (9.84)	250 (9.84)	200 (7.87)	200 (7.87)	250 (9.84)	250 (9.84)
	Thickness t ^{*2}	175 (6.89)	185 (7.28)	210 (8.27)	250 (9.84)	175 (6.89)	175 (6.89)	200 (7.87)	225 (8.86)	211 (8.31)	238 (9.37)	263 (10.35)	177.8 (7.00)	190.5 (7.50)	228.6 (9.00)	254.0 (10.00)	190.5 (7.50)	209.6 (8.25)	254.0 (10.00)	279.4 (11.00)	185 (7.28)	200 (7.87)	220 (8.66)	250 (9.84)	185 (7.28)	200 (7.87)	220 (8.66)	250 (9.84)
	Outer diameter of Grounding ring	66 (2.60)	77 (3.03)	102 (4.02)	128 (5.04)	66 (2.60)	66 (2.60)	77 (3.03)	102 (4.02)	77 (3.03)	102 (4.02)	128 (5.04)	66 (2.60)	77 (3.03)	102 (4.02)	128 (5.04)	66 (2.60)	77 (3.03)	102 (4.02)	128 (5.04)	66 (2.60)	77 (3.03)	102 (4.02)	128 (5.04)	66 (2.60)	77 (3.03)	102 (4.02)	128 (5.04)
Integral flowmeter	Outside dia. ϕD	140 (5.51)	150 (5.91)	175 (6.89)	210 (8.27)	140 (5.51)	140 (5.51)	160 (6.30)	185 (7.28)	168 (6.61)	195 (7.68)	220 (8.66)	139.7 (5.50)	152.4 (6.00)	190.5 (7.50)	215.9 (8.50)	149.4 (5.88)	168.1 (6.62)	200.2 (7.88)	235.0 (9.25)	145 (5.71)	160 (6.30)	180 (7.09)	210 (8.27)	145 (5.71)	160 (6.30)	180 (7.09)	210 (8.27)
	Pitch circle dia. ϕC	45	22.5	22.5	22.5	45	45	22.5	22.5	45	45	30	45	45	22.5	22.5	22.5	22.5	22.5	22.5	45	45	22.5	22.5	45	45	22.5	22.5
	Bolt hole interval θ	19 (0.75)	19 (0.75)	19 (0.75)	23 (0.91)	19 (0.75)	19 (0.75)	23 (0.91)	23 (0.91)	19 (0.75)	19 (0.75)	19 (0.75)	19 (0.75)	19 (0.75)	19 (0.75)	19 (0.75)	22.4 (0.88)	22.4 (0.88)	22.4 (0.88)	22.4 (0.88)	18 (0.71)	18 (0.71)	18 (0.71)	18 (0.71)	18 (0.71)	18 (0.71)	18 (0.71)	18 (0.71)
Remote flowtube	Number of holes N	4	8	8	8	4	4	8	8	4	4	6	4	4	8	8	4	4	8	8	4	4	8	8	4	4	8	8
	Height H1	176 (6.93)	187 (7.36)	211 (8.30)	245 (9.65)	176 (6.93)	176 (6.93)	195 (7.68)	218 (8.59)	255 (10.04)	225 (8.85)	252 (9.90)	177 (6.97)	190 (7.48)	220 (8.66)	247 (9.72)	184 (7.24)	200 (7.87)	233 (9.16)	260 (10.22)	181 (7.13)	195 (7.68)	216 (8.49)	245 (9.65)	181 (7.13)	195 (7.68)	216 (8.49)	245 (9.65)
	Height H2	89 (3.50)	95 (3.74)	106 (4.16)	120 (4.73)	89 (3.50)	89 (3.50)	106 (4.16)	120 (4.73)	106 (4.16)	120 (4.73)	120 (4.73)	89 (3.50)	95 (3.74)	106 (4.16)	120 (4.72)	89 (3.50)	95 (3.74)	106 (4.16)	120 (4.72)	89 (3.50)	95 (3.74)	106 (4.16)	120 (4.72)	89 (3.50)	95 (3.74)	106 (4.16)	120 (4.72)
Integral flowmeter	Max. Height Hr	300 (11.81)	311 (12.24)	335 (13.18)	369 (14.53)	300 (11.81)	300 (11.81)	319 (12.56)	342 (13.47)	379 (14.92)	324 (12.76)	349 (13.73)	301 (11.85)	314 (12.36)	344 (13.54)	371 (14.61)	308 (12.13)	324 (12.76)	357 (14.04)	384 (15.11)	305 (12.01)	319 (12.56)	340 (13.37)	369 (14.53)	305 (12.01)	319 (12.56)	340 (13.37)	369 (14.53)
	Weight kg (lb) ^{*3}	9.0 (19.8)	9.6 (21.2)	12.4 (27.3)	17.4 (38.3)	9.3 (20.5)	9.3 (20.5)	12.4 (27.3)	16.9 (37.3)	24.7 (54.5)	12.2 (26.9)	15.5 (34.2)	19.5 (43.1)	10.8 (23.7)	12.9 (28.5)	17.7 (39.1)	20.8 (45.9)	16.6 (36.6)	26.8 (59.1)	34.9 (76.9)	9.8 (21.6)	11.9 (26.2)	14.5 (32.0)	19.3 (42.5)	9.8 (21.6)	11.9 (26.2)	14.5 (32.0)	19.3 (42.5)
Integral flowmeter	Max. Height Hi	10.7 (0.42)	11.3 (0.45)	14.1 (0.55)	19.1 (0.75)	11.0 (0.43)	11.0 (0.43)	14.1 (0.55)	18.6 (0.73)	26.4 (1.04)	13.2 (0.52)	15.2 (0.60)	21.2 (0.84)	12.5 (0.49)	14.6 (0.57)	19.4 (0.76)	22.5 (0.89)	14.3 (0.56)	18.3 (0.72)	25.6 (1.01)	11.5 (0.45)	13.6 (0.53)	16.2 (0.64)	21.0 (0.83)	11.5 (0.45)	13.6 (0.53)	16.2 (0.64)	21.0 (0.83)
	Weight kg (lb)	23.5 (51.8)	25.0 (55.1)	31.0 (68.4)	42.1 (92.8)	24.3 (53.6)	24.3 (53.6)	31.0 (68.4)	41.0 (90.4)	58.3 (128.5)	30.7 (67.6)	37.8 (83.3)	46.8 (103.1)	27.5 (60.6)	32.2 (71.0)	42.8 (94.3)	31.4 (69.2)	40.4 (89.0)	62.8 (138.5)	80.7 (177.8)	25.4 (56.0)	29.9 (65.9)	35.7 (78.6)	46.2 (101.7)	25.4 (56.0)	29.9 (65.9)	35.7 (78.6)	46.2 (101.7)

- *1: When indicator code N is selected, subtract 12 mm (0.47 inch) from the value in the figure. In case of explosion proof type with indicator, add 5 mm (0.2 inch) to it.
- *2: Depending on the selection of grounding ring code and optional code, add the following value to "L" (face-to-face length) and "t" (thickness of flange).

Grounding Ring Code	L		t	
	S, L, H, V	P, T	N	N
Option Code	None	+0	+26(1.02)	+13(0.51)
GA, GC, GD (Special Gaskets)	+8(0.31)	+4(0.16)	+30(1.18)	+15(0.59)

- *3: When submersible type or option code DHC is selected, waterproof glands and a 30m long cable are attached. Add 9.5kg(20.9lb) to the weight in the table.

● AXF Standard, AXF150, AXF200, JIS/ANSI/DIN Flange Type, PFA /Polyurethane Rubber /Natural Soft Rubber /EPDM Rubber Lining

Unit : mm (approx. inch)

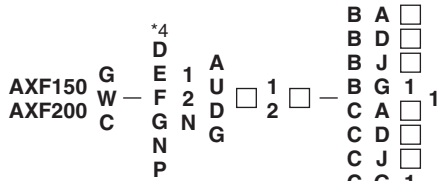

*4: D, E, F, G; Integral Flowmeter, N, P; Remote Flowtube

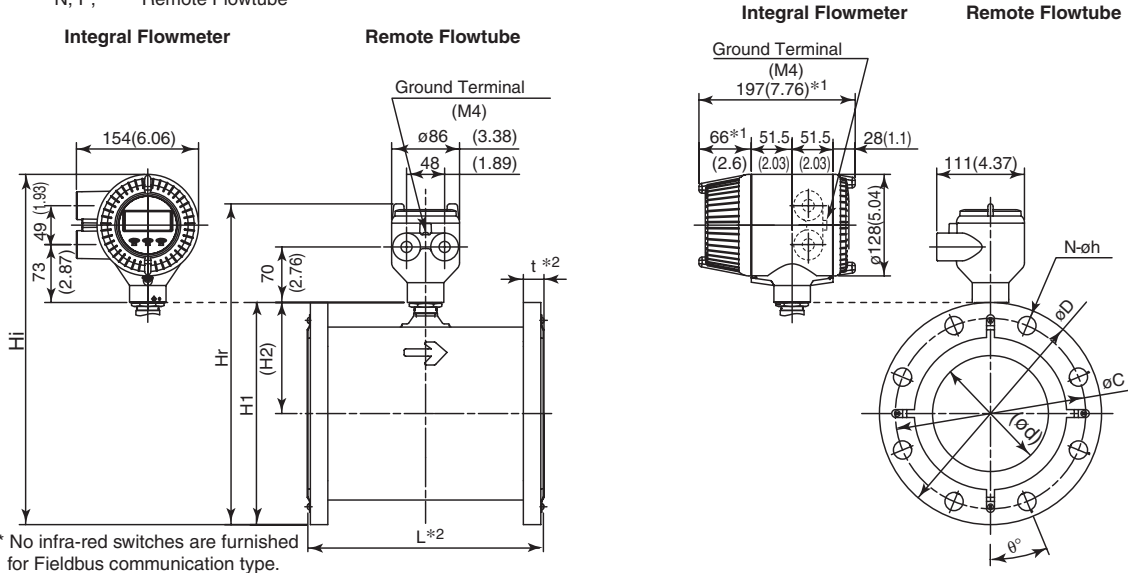

* No infra-red switches are furnished for Fieldbus communication type.

Model	Process Connection	BJ1/CJ1(JIS10K)		BJ2/CJ2(JIS20K)		BG1/CG1(JIS F12)		BA1/CA1(ANSI Class 150)		BA2/CA2(ANSI Class 300)		BD1/CD1(DIN PN10)		BD2/CD2(DIN PN16)	
	Size code	150	200	150	200	150	200	150	200	150	200	200	150	200	
	Size	150 (6)	200 (8)	150 (6)	200 (8)	150 (6)	200 (8)	150 (6)	200 (8)	150 (6)	200 (8)	200 (8)	150 (6)	200 (8)	
	Lining code	A,U D,G	A,U D,G	A,U D,G	A,U D,G	A,U D,G	A,U D,G	A,U D,G	A,U D,G	A,U D,G	A,U D,G	A,U D,G	A,U D,G	A,U D,G	
Remote flowtube	Face-to-face length	L ^{*2}	300 (11.81)	350 (13.78)	300 (11.81)	350 (13.78)	300 (11.81)	350 (13.78)	300 (11.81)	350 (13.78)	300 (11.81)	350 (13.78)	350 (13.78)	300 (11.81)	350 (13.78)
	Outside dia.	øD	280 (11.02)	330 (12.99)	305 (12.01)	350 (13.78)	290 (11.42)	342 (13.46)	279.4 (11.00)	342.9 (13.50)	317.5 (12.50)	381.0 (15.00)	340 (13.39)	285 (11.22)	340 (13.39)
	Thickness	t ^{*2}	27 (1.06)	27 (1.06)	33 (1.30)	35 (1.38)	27 (1.06)	29 (1.14)	30.4 (1.20)	33.4 (1.31)	43.5 (1.71)	46.1 (1.81)	29 (1.14)	27 (1.06)	29 (1.14)
	Inner diameter of Grounding ring	ød	146.1 (5.75)	193.6 (7.62)	146.1 (5.75)	193.6 (7.62)	146.1 (5.75)	193.6 (7.62)	146.1 (5.75)	193.6 (7.62)	146.1 (5.75)	193.6 (7.62)	193.6 (7.62)	146.1 (5.75)	193.6 (7.62)
	Pitch circle dia.	øC	240 (9.45)	290 (11.42)	260 (10.24)	305 (12.01)	247 (9.72)	299 (11.77)	241.3 (9.50)	298.5 (11.75)	269.7 (10.62)	330.2 (13.00)	295 (11.61)	240 (9.45)	295 (11.61)
Integral flowmeter	Bolt hole interval	θ°	22.5	15	15	15	30	22.5	22.5	22.5	15	15	22.5	22.5	15
	Hole dia.	øh	23 (0.91)	23 (0.91)	25 (0.98)	25 (0.98)	19 (0.75)	19 (0.75)	22.4 (0.88)	22.4 (0.88)	22.4 (0.88)	25.4 (1.00)	22 (0.87)	22 (0.87)	22 (0.87)
	Number of holes	N	8	12	12	12	6	8	8	8	12	12	8	8	12
Remote flowtube	Height	H1	281 (11.06)	331 (13.03)	294 (11.56)	341 (13.43)	286 (11.26)	337 (13.27)	281 (11.05)	337 (13.29)	300 (11.80)	357 (14.04)	336 (13.23)	284 (11.16)	336 (13.23)
	Height	H2	141 (5.55)	166 (6.54)	141 (5.55)	166 (6.54)	141 (5.55)	166 (6.54)	141 (5.55)	166 (6.54)	141 (5.55)	166 (6.54)	166 (6.54)	141 (5.55)	166 (6.54)
Integral flowmeter	Max. Height	Hr	405 (15.94)	455 (17.91)	418 (16.44)	465 (18.31)	410 (16.14)	461 (18.15)	405 (15.93)	461 (18.17)	424 (16.68)	481 (18.92)	460 (18.11)	408 (16.04)	460 (18.11)
	Weight kg (lb) ^{*3}		27.8 (61.3)	37.3 (82.2)	37.1 (81.8)	51.9 (114.4)	29.9 (65.9)	43.2 (95.3)	30.9 (68.0)	49.2 (108.4)	52.5 (115.7)	78.8 (173.7)	42.5 (93.7)	28.7 (63.2)	41.9 (92.5)

- *1: When indicator code N is selected, subtract 12 mm (0.47 inch) from the value in the figure. In case of explosion proof type with indicator, add 5 mm (0.2 inch) to it.
- *2: Depending on the selection of grounding ring code and optional code, add the following value to "L" (face-to-face length) and "t" (thickness of flange).

Option Code	Grounding Ring Code	L		t			
		S, L, H, V	P, T	N	N		
None	GA, GC, GD (Special Gaskets)	+0	+0	+32(1.26)	+16(0.63)	-2(0.08)	-1(0.04)
		+10(0.39)	+5(0.20)	+38(1.5)	+19(0.75)	-	-

*3: When submersible type or option code DHC is selected, waterproof glands and a 30m long cable are attached. Add 9.5kg(20.9lb) to the weight in the table.

● AXF Standard, AXF250-AXF400, JIS/ANSI/DIN Flange Type, PFA /Polyurethane Rubber /Natural Soft Rubber /EPDM Rubber Lining

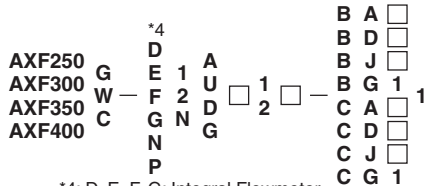

Unit : mm (approx. inch)

*4: D, E, F, G; Integral Flowmeter, N, P; Remote Flowtube

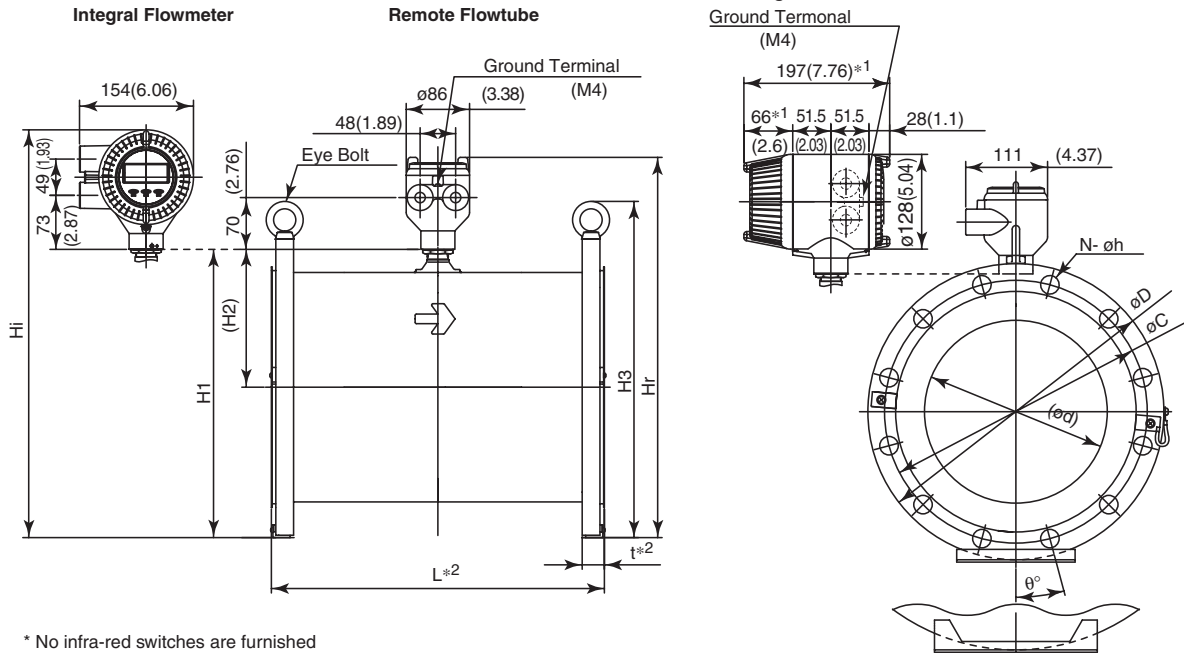

* No infra-red switches are furnished for Fieldbus communication type.

for AXF300, AXF350, AXF400

Model	Process Connection	BJ1/CJ1 (JIS10K)				BJ2/CJ2 (JIS20K)				BG1/CG1 (JIS F12)				BA1/CA1 (ANSI Class 150)				BA2/CA2 (ANSI Class 300)		BD1/CD1 (DIN PN10)				BD2/CD2 (DIN PN16)		
		250		300		350		400		250		300		350		400		250	300	250		300		250	300	
		A.U.	D.G.	A.U.	D.G.	A.U.	D.G.	A.U.	D.G.	A.U.	D.G.	A.U.	D.G.	A.U.	D.G.	A.U.	D.G.	A.U.	D.G.	A.U.	D.G.	A.U.	D.G.	A.U.	D.G.	
	Lining code	450	500	550	600	450	500	550	600	450	500	550	600	450	500	550	600	450	500	550	600	450	500	550	600	
Remote flowtube	Face-to-face length	L ₀₋₅ ^{#2}	(17.72)	(19.69)	(21.65)	(23.62)	(17.72)	(19.69)	(21.65)	(23.62)	(17.72)	(19.69)	(21.65)	(23.62)	(17.72)	(19.69)	(21.65)	(23.62)	(17.72)	(19.69)	(21.65)	(23.62)	(17.72)	(19.69)	(21.65)	(23.62)
	Outside dia.	øD	400	445	490	560	430	480	530	582	406.4	482.6	533.4	596.9	444.5	520.7	395	445	505	565	405	460	515	575	635	
	Thickness	t ^{#2}	32	34	36	38	42	44	46	48	32	34	36	38	42	44	46	48	52	54	56	60	62	64	68	72
	Inner diameter of Grounding ring	ød	243	291.3	323.4	373.5	243	291.3	323.4	373.5	243	291.3	323.4	373.5	243	291.3	323.4	373.5	243	291.3	323.4	373.5	243	291.3	323.4	373.5
Integral flowmeter	Pitch circle dia.	øC	355	400	445	510	380	430	480	530	414	472	524	582.0	431.8	476.3	539.8	387.4	450.9	350	400	460	515	575	635	700
	Bolt hole interval	ø*	15	11.25	11.25	15	11.25	22.5	18	18	15	15	15	15	11.25	11.25	11.25	15	15	11.25	11.25	15	15	11.25	11.25	
	Hole dia.	øH	25	25	25	27	27	23	23	25	25.4	25.4	28.4	28.4	28.4	31.8	22	22	22	26	26	26	26	26	26	
	Number of holes	N	12	16	16	16	12	16	8	10	10	12	12	12	12	16	16	16	12	12	16	16	12	12	12	
Remote flowtube	Max. Height	Hr	524	571	615	677	539	588	635	688	527	590	636	696	546	609	521	571	622	680	526	578	636	696	760	
	Weight kg (lb) ^{#3}		70.0	78.0	107.0	135.0	98.5	114.5	73.4	85.0	121.2	137.0	83.4	104.8	151.8	185.3	133.0	176.7	73.0	79.4	112.5	129.7	74.8	87.9	119.8	
			(154.3)	(172.0)	(235.9)	(297.6)	(217.2)	(252.4)	(161.7)	(187.4)	(267.2)	(301.9)	(183.8)	(231.0)	(334.7)	(408.5)	(293.1)	(389.5)	(161.0)	(174.9)	(248.0)	(285.9)	(164.9)	(193.8)	(426.6)	
			(22.13)	(23.98)	(25.71)	(28.15)	(22.72)	(24.65)	(22.32)	(24.33)	(26.50)	(28.58)	(22.24)	(24.72)	(26.54)	(28.90)	(22.99)	(25.47)	(22.01)	(23.98)	(25.98)	(28.27)	(22.20)	(24.25)	(26.50)	
Integral flowmeter	Max. Height	Hi	71.7	79.7	108.7	136.7	100.2	116.2	75.1	86.7	122.9	138.7	85.1	106.5	153.5	187.0	134.7	178.4	74.7	81.1	114.2	131.4	76.5	89.6	120.0	
	Weight kg (lb)		(158.1)	(175.7)	(239.6)	(301.4)	(220.9)	(256.2)	(165.5)	(191.2)	(270.9)	(305.7)	(187.6)	(234.8)	(338.4)	(412.3)	(296.9)	(393.3)	(164.7)	(178.7)	(251.7)	(289.6)	(168.7)	(197.6)	(426.6)	

*1: When indicator code N is selected, subtract 12 mm (0.47 inch) from the value in the figure.

In case of explosion proof type with indicator, add 5 mm (0.2 inch) to it.

*2: Depending on the selection of grounding ring code and optional code, add the following value to "L" (face-to-face length) and "t" (thickness of flange).

Nominal Size: 250 mm to 300 mm					Nominal Size: 350 mm to 400 mm				
	L	t	L	t		L	t	L	t
Grounding Ring Code	S, L, H, V		N			S, L, H, V		N	
Option Code is "None"	+0	+0	-6(0.24)	-3(0.12)		+0	+0	-10(0.39)	-5(0.20)

*3: When submersible type or option code DHC is selected, waterproof glands and a 30m long cable are attached. Add 9.5kg(20.9lb) to the weight in the table.

● AXF Standard, AXF015-AXF125, Sanitary for Clamp Connection, PFA Lining

Unit : mm (approx. inch)

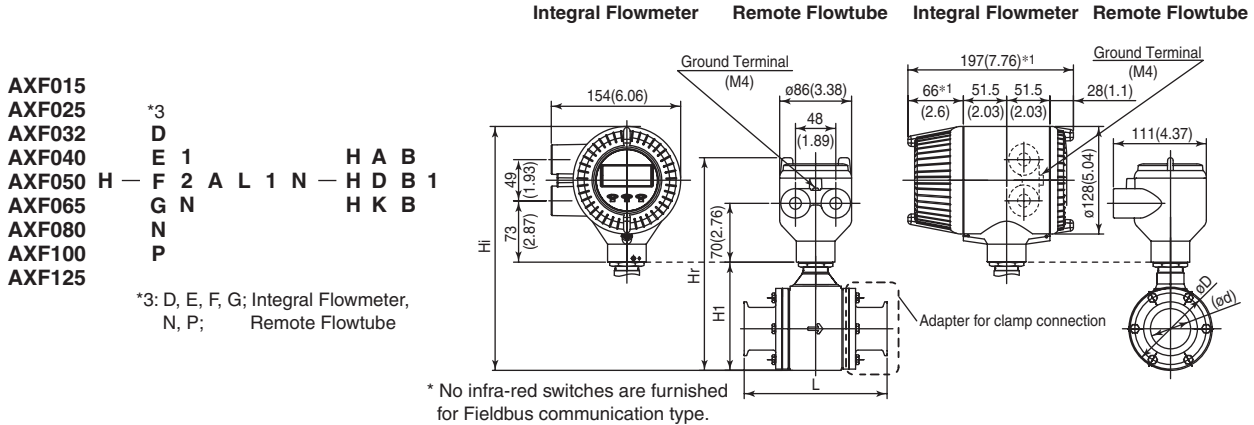

- AXF015
- AXF025 *3
- AXF032 D
- AXF040 E 1
- AXF050 H - F 2 A L 1 N - H A B
- AXF065 G N H D B 1
- AXF080 N H K B
- AXF100 P
- AXF125

*3: D, E, F, G; Integral Flowmeter, N, P; Remote Flowtube

* No infra-red switches are furnished for Fieldbus communication type.

Model	Process Connection		HAB / HDB / HKB										
	Size code		015	025	032	040	050	065	080	100	125		
	Size		15 (0.5)	25 (1)	32 (1.3)	40 (1.5)	50 (2)	65 (2.6)	80 (3)	100 (4)	125 (5)		
Lining code		A	A	A	A	A	A	A	A	A			
Remote Flowtube	Face-to-face length	L	166 (6.55)	166 (6.55)	166 (6.55)	166 (6.55)	176 (6.94)	196 (7.73)	216 (8.52)	246 (9.70)	316 (12.46)		
	Outside dia.	øD	73 (2.87)	73 (2.87)	73 (2.87)	86 (3.39)	99 (3.90)	117 (4.61)	129 (5.08)	155 (6.10)	183 (7.20)		
Integral Flowmeter	Inner dia.	ød	HAB	15.7 (0.62)	22.1 (0.87)	-	34.8 (1.37)	47.5 (1.87)	60.2 (2.37)	72.9 (2.87)	97.4 (3.83)	-	
			HDB	16 (0.63)	26 (1.02)	32 (1.26)	38 (1.50)	50 (1.97)	66 (2.60)	81 (3.19)	100 (3.94)	125 (4.92)	125 (4.92)
			HKB	15.2 (0.60)	22.6 (0.89)	31.3 (1.23)	35.6 (1.40)	48.6 (1.91)	60.3 (2.37)	72.9 (2.87)	97.6 (3.84)	135.7 (5.34)	
Height	H1	98 (3.86)	98 (3.86)	98 (3.86)	111 (4.37)	129 (5.08)	147 (5.79)	157 (6.18)	183 (7.20)	212 (8.35)			
Remote Flowtube	Max. Height	Hr	222 (8.74)	222 (8.74)	222 (8.74)	235 (9.25)	253 (9.96)	271 (10.67)	281 (11.06)	307 (12.09)	336 (13.23)		
	Weight kg (lb)*2	2.7 (6.0)	2.5 (5.5)	2.6 (5.7)	2.9 (6.4)	3.6 (7.9)	4.8 (10.6)	5.7 (12.6)	8.1 (17.9)	12.1 (26.7)			
Integral Flowmeter	Max. Height	Hi	260 (10.22)	260 (10.22)	260 (10.22)	273 (10.73)	291 (11.44)	309 (12.15)	319 (12.54)	345 (13.56)	374 (14.70)		
	Weight kg (lb)	4.4 (9.7)	4.2 (9.3)	4.3 (9.5)	4.6 (10.1)	5.3 (11.7)	6.5 (14.3)	7.4 (16.3)	9.8 (21.6)	13.8 (30.4)			

*1: When indicator code N is selected, subtract 12 mm (0.47 inch) from the value in the figure.

*2: When option code DHC is selected, waterproof glands and a 30m long cable are attached. Add 9.5kg(20.9lb) to the weight in the table.

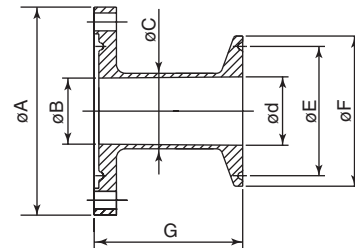

Adapter for clamp connection

Process Connection	HAB (Tri-Clamp)								HDB (DIN 32676 Clamp)								HKB (ISO2852 Clamp)									
	15	25	40	50	65	80	100		15	25	32	40	50	65	80	100	125	15	25	32	40	50	65	80	100	125
øA	70 (2.76)	70 (2.76)	83 (3.27)	96 (3.78)	114 (4.49)	126 (4.96)	152 (5.98)		70 (2.76)	70 (2.76)	70 (2.76)	83 (3.27)	96 (3.78)	114 (4.49)	126 (4.96)	152 (5.98)	180 (7.09)	70 (2.76)	70 (2.76)	70 (2.76)	83 (3.27)	96 (3.78)	114 (4.49)	126 (4.96)	152 (5.98)	180 (7.09)
øB	16 (0.63)	22.2 (0.87)	34.6 (1.36)	47.6 (1.87)	59.5 (2.34)	72.3 (2.85)	97 (3.82)		16 (0.63)	22.2 (0.87)	29.4 (1.16)	34.6 (1.36)	47.6 (1.87)	59.5 (2.34)	72.3 (2.85)	97 (3.82)	123 (4.84)	16 (0.63)	22.2 (0.87)	29.4 (1.16)	34.6 (1.36)	47.6 (1.87)	59.5 (2.34)	72.3 (2.85)	97 (3.82)	123 (4.84)
øC	19.2 (0.76)	25.4 (1.00)	38.1 (1.50)	50.8 (2.00)	63.5 (2.50)	76.2 (3.00)	101.6 (4.00)		20 (0.79)	30 (1.18)	36 (1.42)	42 (1.65)	54 (2.13)	70 (2.76)	85 (3.35)	104 (4.09)	129 (5.08)	18 (0.71)	25.6 (1.01)	34.3 (1.35)	38.6 (1.52)	51.6 (2.03)	64.1 (2.52)	76.7 (3.02)	102.5 (4.04)	141.2 (5.56)
ød	15.7 (0.62)	22.1 (0.87)	34.8 (1.37)	47.5 (1.87)	60.2 (2.37)	72.9 (2.87)	97.4 (3.83)		16 (0.63)	26 (1.02)	32 (1.26)	38 (1.50)	50 (1.97)	66 (2.60)	81 (3.19)	100 (3.94)	125 (4.92)	15.2 (0.60)	22.6 (0.89)	31.3 (1.23)	35.6 (1.40)	48.6 (1.91)	60.3 (2.37)	72.9 (2.87)	97.6 (3.84)	135.7 (5.34)
øE	-	43.6 (1.72)	43.6 (1.72)	56.3 (2.22)	70.6 (2.78)	83.3 (3.28)	110.3 (4.34)		27.5 (1.08)	43.5 (1.71)	43.5 (1.71)	43.5 (1.71)	56.5 (2.22)	83.5 (3.29)	97 (3.82)	110 (4.33)	146 (5.75)	27.5 (1.08)	43.5 (1.71)	43.5 (1.71)	56.5 (2.22)	83.5 (3.29)	97 (3.82)	110 (4.33)	146 (5.75)	110 (4.33)
øF	25 (0.98)	50.4 (1.98)	50.4 (1.98)	64 (2.52)	77.4 (3.05)	91 (3.58)	118.9 (4.68)		34 (1.34)	50.5 (1.99)	50.5 (1.99)	50.5 (1.99)	64 (2.52)	91 (3.58)	106 (4.17)	119 (4.69)	155 (6.10)	34 (1.34)	50.5 (1.99)	50.5 (1.99)	64 (2.52)	77.5 (3.05)	91 (3.58)	119 (4.69)	155 (6.10)	
G	50 (1.97)	50 (1.97)	50 (1.97)	50 (1.97)	50 (1.97)	50 (1.97)	50 (1.97)		50 (1.97)	50 (1.97)	50 (1.97)	50 (1.97)	50 (1.97)	50 (1.97)	50 (1.97)	50 (1.97)	50 (1.97)	50 (1.97)	50 (1.97)	50 (1.97)	50 (1.97)	50 (1.97)	50 (1.97)	50 (1.97)	50 (1.97)	50 (1.97)
Parts No.	F9811 HU	F9811 HV	F9811 HX	F9811 HY	F9811 HZ	F9811 JA	F9811 JB	F9811 JD	F9811 JE	F9811 JF	F9811 JG	F9811 JH	F9811 JI	F9811 JJ	F9811 JK	F9811 JL	F9811 JM	F9811 JN	F9811 JP	F9811 JQ	F9811 JR	F9811 JS	F9811 JT	F9811 JU	F9811 JV	F9811 JW

F34.EPS

● AXF Standard, AXF015-AXF125, Sanitary for Union Connection, PFA Lining

Unit : mm (approx. inch)

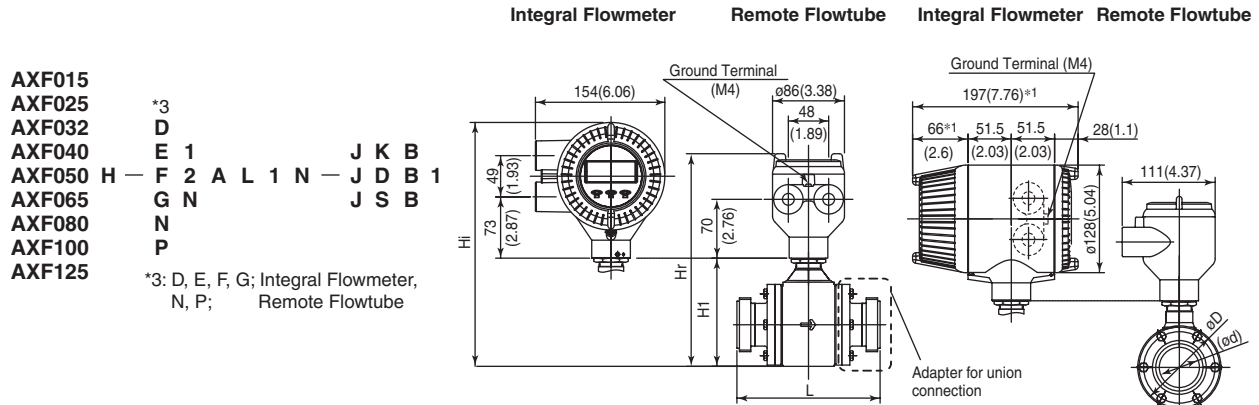

- AXF015
 - AXF025 *3
 - AXF032 D
 - AXF040 E 1 J K B
 - AXF050 H — F 2 A L 1 N — J D B 1
 - AXF065 G N J S B
 - AXF080 N
 - AXF100 P
 - AXF125
- *3: D, E, F, G; Integral Flowmeter, N, P; Remote Flowtube

* No infra-red switches are furnished for Fieldbus communication type.

Model	Process Connection		JKB / JDB / JSB										
	Size code		015	025	032	040	050	065	080	100	125		
	Size		15 (0.5)	25 (1)	32 (1.3)	40 (1.5)	50 (2)	65 (2.6)	80 (3)	100 (4)	125 (5)		
Lining code		A	A	A	A	A	A	A	A	A			
Remote Flowtube	Face-to-face length	L	JKB	166 (6.55)	166 (6.55)	166 (6.55)	166 (6.55)	176 (6.94)	196 (7.73)	216 (8.52)	246 (9.70)		
		JDB	166 (6.55)	166 (6.55)	166 (6.55)	166 (6.55)	176 (6.94)	196 (7.73)	236 (9.31)	266 (10.49)	326 (12.85)		
		JSB	—	166 (6.55)	166 (6.55)	166 (6.55)	176 (6.94)	196 (7.73)	216 (8.52)	276 (10.88)			
	Outside dia.	∅D	73 (2.87)	73 (2.87)	73 (2.87)	86 (3.39)	99 (3.90)	117 (4.61)	129 (5.08)	155 (6.10)	183 (7.20)		
Integral Flowmeter	Inside dia.	∅d	JKB	15.2 (0.60)	22.6 (0.89)	31.3 (1.23)	35.6 (1.40)	48.6 (1.91)	60.3 (2.37)	72.9 (2.87)	97.6 (3.84)		
		JDB	16 (0.63)	26 (1.02)	32 (1.26)	38 (1.50)	50 (1.97)	66 (2.60)	81 (3.19)	100 (3.94)	125 (4.92)		
		JSB	—	22.5 (0.89)	29.6 (1.17)	35.5 (1.40)	48.5 (1.91)	60.5 (2.38)	72.9 (2.87)	97.6 (3.84)			
Height	H1	98 (3.86)	98 (3.86)	98 (3.86)	111 (4.37)	129 (5.08)	147 (5.79)	157 (6.18)	183 (7.20)	212 (8.35)			
Remote Flowtube	Max. Height	Hr	222 (8.74)	222 (8.74)	222 (8.74)	235 (9.25)	253 (9.96)	271 (10.67)	281 (11.06)	307 (12.09)	336 (13.23)		
	Weight kg (lb)*2		2.6 (5.7)	2.6 (5.7)	2.7 (6.0)	3 (6.6)	3.8 (8.4)	4.9 (10.8)	5.9 (13.0)	8.2 (18.1)	13 (28.7)		
Integral Flowmeter	Max. Height	Hi	260 (10.24)	260 (10.24)	260 (10.24)	273 (10.73)	291 (11.44)	309 (12.17)	319 (12.54)	345 (13.56)	374 (14.70)		
	Weight kg (lb)		4.3 (9.5)	4.3 (9.5)	4.4 (9.7)	4.7 (10.4)	5.5 (12.1)	6.6 (14.6)	7.6 (16.8)	9.9 (21.8)	14.7 (32.4)		

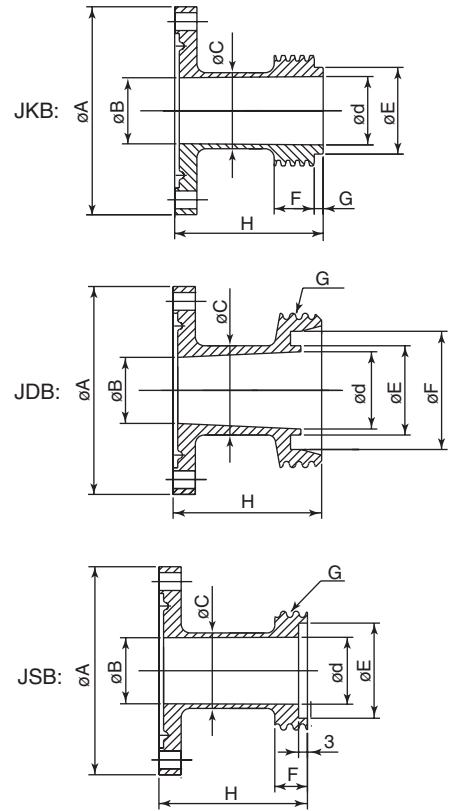

Adapters for union connection

*1: When indicator code N is selected, subtract 12 mm (0.47 inch) from the value in the figure.
 *2: When option code DHC is selected, waterproof glands and a 30m long cable are attached. Add 9.5kg (20.9lb) to the weight in the table.

Process Connection	JKB (ISO2853 Union)										JDB (DIN 11851 Union)										JSB (SMS1145 Union)							
	15	25	32	40	50	65	80	100	15	25	32	40	50	65	80	100	125	25	32	40	50	65	80	100				
∅A	70 (2.76)	70 (2.76)	70 (2.76)	83 (3.27)	96 (3.78)	114 (4.49)	126 (4.96)	152 (5.98)	70 (2.76)	70 (2.76)	70 (2.76)	83 (3.27)	96 (3.78)	114 (4.49)	126 (4.96)	152 (5.98)	180 (7.09)	70 (2.76)	70 (2.76)	83 (3.27)	96 (3.78)	114 (4.49)	126 (4.96)	152 (5.98)				
∅B	16 (0.63)	22.2 (0.87)	29.4 (1.16)	34.6 (1.36)	47.6 (1.87)	59.5 (2.34)	72.3 (2.85)	97 (3.82)	16 (0.63)	22.2 (0.87)	29.4 (1.16)	34.6 (1.36)	47.6 (1.87)	59.5 (2.34)	72.3 (2.85)	97 (3.82)	123 (4.84)	22.2 (0.87)	29.4 (1.16)	34.6 (1.36)	47.6 (1.87)	59.5 (2.34)	72.3 (2.85)	97 (3.82)				
∅C	18 (0.71)	25.6 (1.01)	34.3 (1.35)	38.6 (1.52)	51.6 (2.03)	64.1 (2.52)	76.7 (3.02)	102.5 (4.04)	20 (0.79)	30 (1.18)	36 (1.42)	42 (1.65)	54 (2.13)	71 (2.76)	85 (3.35)	104 (4.09)	129 (5.08)	25.4 (1.00)	32 (1.26)	38.1 (1.50)	51 (2.01)	63.5 (2.50)	76.2 (3.00)	102.5 (4.04)				
∅D	15.2 (0.60)	22.6 (0.89)	31.3 (1.23)	35.6 (1.40)	48.6 (1.91)	60.3 (2.37)	72.9 (2.87)	97.6 (3.84)	16 (0.63)	26 (1.02)	32 (1.26)	38 (1.50)	50 (1.97)	66 (2.60)	81 (3.19)	100 (3.94)	125 (4.92)	22.5 (0.89)	29.6 (1.17)	35.5 (1.40)	48.5 (1.91)	60.5 (2.38)	72.9 (2.87)	97.6 (3.84)				
∅E	21.2 (0.83)	29.2 (1.15)	38.2 (1.50)	42.7 (1.68)	56.2 (2.21)	69.9 (2.75)	82.6 (3.25)	108.7 (4.28)	18 (0.71)	30 (1.18)	36 (1.42)	42 (1.65)	54 (2.13)	71 (2.80)	85 (3.35)	104 (4.09)	130 (5.12)	32 (1.26)	40 (1.57)	48 (1.89)	61 (2.40)	73.5 (2.88)	86 (3.39)	120 (4.72)				
∅F	13.5 (0.53)	13.5 (0.53)	13.5 (0.53)	13.5 (0.53)	13.5 (0.53)	13.5 (0.53)	13.5 (0.53)	25.8 (1.02)	25.8 (1.02)	39.8 (1.57)	45.8 (1.80)	51.8 (2.04)	63.8 (2.51)	80.8 (3.18)	94.8 (3.73)	113.8 (4.48)	141.8 (5.58)	11 (0.43)	13 (0.51)	15 (0.59)	15 (0.59)	19 (0.75)	19 (0.75)	30 (1.18)				
G	3 (0.12)	3 (0.12)	3 (0.12)	3 (0.12)	3 (0.12)	3 (0.12)	3 (0.12)	RD34 ×1/8"	RD34 ×1/8"	RD58 ×1/6"	RD58 ×1/6"	RD65 ×1/6"	RD78 ×1/6"	RD95 ×1/6"	RD110 ×1/4"	RD130 ×1/4"	RD160 ×1/4"	RD40 ×1/6"	RD48 ×1/6"	RD60 ×1/6"	RD70 ×1/6"	RD85 ×1/6"	RD98 ×1/6"	RD132 ×1/6"				
H	50 (1.97)	50 (1.97)	50 (1.97)	50 (1.97)	50 (1.97)	50 (1.97)	50 (1.97)	50 (1.97)	50 (1.97)	50 (1.97)	50 (1.97)	50 (1.97)	50 (1.97)	50 (1.97)	60 (2.36)	60 (2.36)	65 (2.56)	50 (1.97)	50 (1.97)	50 (1.97)	50 (1.97)	50 (1.97)	50 (1.97)	65 (2.56)				
Parts No.	F9811 LA	F9811 LB	F9811 LC	F9811 LD	F9811 LE	F9811 LF	F9811 LG	F9811 LH	F9811 KR	F9811 KS	F9811 KT	F9811 KU	F9811 KV	F9811 KW	F9811 KX	F9811 KY	F9811 KZ	F9811 LK	F9811 LL	F9811 LM	F9811 LN	F9811 LO	F9811 LP	F9811 LR				

F35.EPS

● AXF Standard, AXF015-AXF125, Sanitary for Butt Weld, PFA Lining

Unit : mm (approx. inch)

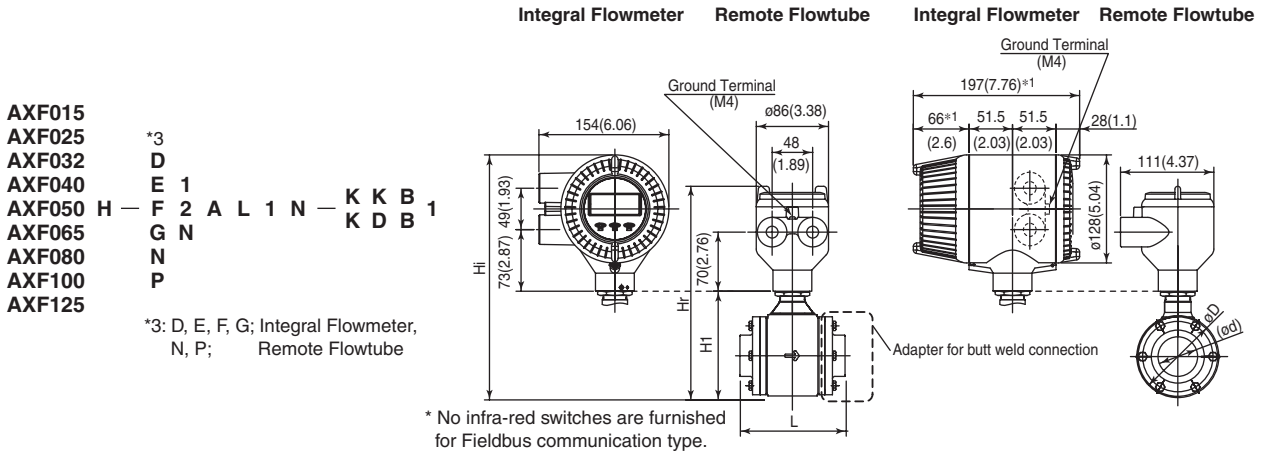

AXF015
 AXF025
 AXF032
 AXF040
 AXF050
 AXF065
 AXF080
 AXF100
 AXF125

*3
 D
 E 1
 F 2
 G N
 N
 P

H — F 2 A L 1 N — K K B 1
 K D B 1

*3: D, E, F, G; Integral Flowmeter,
 N, P; Remote Flowtube

* No infra-red switches are furnished for Fieldbus communication type.

Model	Process Connection		KKB / KDB									
	Size code		015	025	032	040	050	065	080	100	125	
	Size		15 (0.5)	25 (1)	32 (1.3)	40 (1.5)	50 (2)	65 (2.6)	80 (3)	100 (4)	125 (5)	
Lining code		A	A	A	A	A	A	A	A	A		
Remote Flowtube	Face-to-face length	L	126 (4.98)	126 (4.98)	126 (4.98)	126 (4.98)	136 (5.37)	156 (6.16)	176 (6.94)	206 (8.13)	276 (10.88)	
	Outside dia.	øD	73 (2.87)	73 (2.87)	73 (2.87)	86 (3.39)	99 (3.90)	117 (4.61)	129 (5.08)	155 (6.10)	183 (7.20)	
Integral Flowmeter	Inner dia.	ød	KKB	15.2 (0.60)	22.6 (0.89)	31.3 (1.23)	35.6 (1.40)	48.6 (1.91)	60.3 (2.37)	72.9 (2.87)	97.6 (3.84)	135.7 (5.34)
				KDB	16 (0.63)	26 (1.02)	32 (1.26)	38 (1.50)	50 (1.97)	66 (2.60)	81 (3.19)	100 (3.94)
Remote Flowtube	Height	H1	98 (3.86)	98 (3.86)	98 (3.86)	111 (4.37)	129 (5.08)	147 (5.79)	157 (6.18)	183 (7.20)	212 (8.35)	
	Max. Height	Hr	222 (8.74)	222 (8.74)	222 (8.74)	235 (9.25)	253 (9.96)	271 (10.67)	281 (11.06)	307 (12.09)	336 (13.23)	
Integral Flowmeter	Weight kg (lb)	^{*2}	2.6 (5.7)	2.3 (5.1)	2.5 (5.5)	2.8 (6.2)	3.4 (7.5)	4.5 (9.9)	5.3 (11.7)	7.1 (15.7)	11 (24.3)	
	Max. Height	Hi	260 (10.24)	260 (10.24)	260 (10.24)	273 (10.73)	291 (11.44)	309 (12.17)	319 (12.54)	345 (13.56)	374 (14.70)	
Integral Flowmeter	Weight kg (lb)		4.3 (9.5)	4 (8.8)	4.2 (9.3)	4.5 (9.9)	5.1 (11.2)	6.2 (13.7)	7 (15.4)	8.8 (19.4)	12.7 (28.0)	

*1: When indicator code N is selected, subtract 12 mm (0.47 inch) from the value in the figure.
 *2: When option code DHC is selected, waterproof glands and a 30m long cable are attached. Add 9.5kg (20.9lb) to the weight in the table.

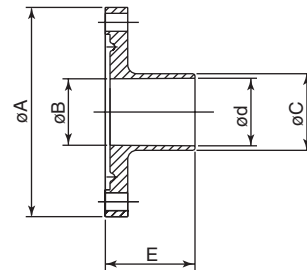

Adapter for butt weld connection

Process Connection	KKB (ISO2037 Butt Weld)								KDB (DIN 1185 Butt Weld)									
Nominal Size	15	25	32	40	50	65	80	100	125	15	25	32	40	50	65	80	100	125
øA	70 (2.76)	70 (2.76)	70 (2.76)	83 (3.27)	96 (3.78)	114 (4.49)	126 (4.96)	152 (5.98)	180 (7.09)	70 (2.76)	70 (2.76)	70 (2.76)	83 (3.27)	96 (3.78)	114 (4.49)	126 (4.96)	152 (5.98)	180 (7.09)
øB	16 (0.63)	22.2 (0.87)	29.4 (1.16)	34.6 (1.36)	47.6 (1.87)	59.5 (2.34)	72.3 (2.85)	97 (3.82)	123 (4.84)	16 (0.63)	22.2 (0.87)	29.4 (1.16)	34.6 (1.36)	47.6 (1.87)	59.5 (2.34)	72.3 (2.85)	97 (3.82)	123 (4.84)
øC	18 (0.71)	25.6 (1.01)	34.3 (1.35)	38.6 (1.52)	51.6 (2.03)	64.1 (2.52)	76.7 (3.02)	102.5 (4.04)	141.2 (5.56)	20 (0.79)	30 (1.18)	36 (1.42)	42 (1.65)	54 (2.13)	70 (2.76)	85 (3.35)	104 (4.09)	129 (5.08)
ød	15.2 (0.60)	22.6 (0.89)	31.3 (1.23)	35.6 (1.40)	48.6 (1.91)	60.3 (2.37)	72.9 (2.87)	97.6 (3.84)	135.7 (5.34)	16 (0.63)	26 (1.02)	32 (1.26)	38 (1.50)	50 (1.97)	66 (2.60)	81 (3.19)	100 (3.94)	125 (4.92)
E	30 (1.18)	30 (1.18)	30 (1.18)	30 (1.18)	30 (1.18)	30 (1.18)	30 (1.18)	30 (1.18)	40 (1.57)	30 (1.18)	30 (1.18)	30 (1.18)	30 (1.18)	30 (1.18)	30 (1.18)	30 (1.18)	30 (1.18)	40 (1.57)
Parts No.	F9811 NN	F9811 NP	F9811 NQ	F9811 NR	F9811 NS	F9811 NT	F9811 NU	F9811 NV	F9811 NW	F9811 ND	F9811 NE	F9811 NF	F9811 NG	F9811 NH	F9811 NJ	F9811 NK	F9811 NL	F9811 NM

F36.EPS

● Replacement model for Earlier ADMAG or ADMAG AE, AXF002-AXF015, Wafer Type, PFA Lining

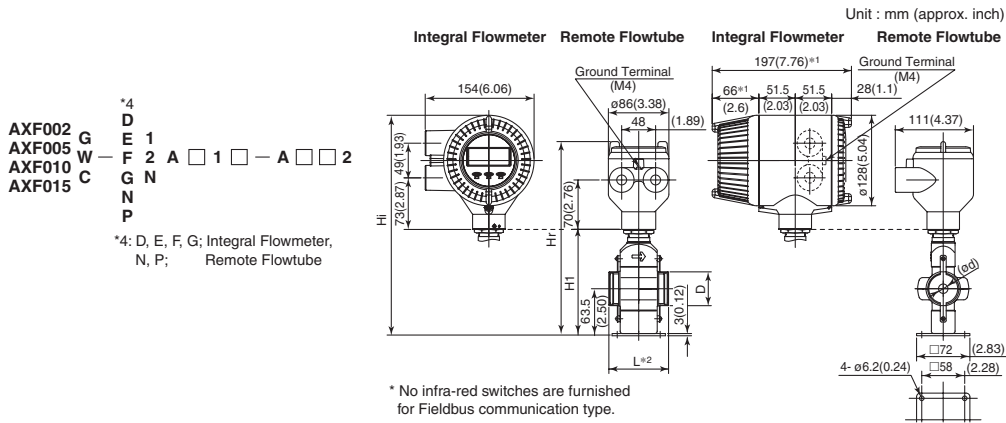

AXF002 G
 AXF005 W
 AXF010 C
 AXF015 C

*4 D E 1
 F 2 A □ 1 □ - A □ □ 2
 G N
 P

*4: D, E, F, G; Integral Flowmeter,
 N, P; Remote Flowtube

Model	Size code	002	005	010	015
	Size	2.5(0.1)	5(0.2)	10(0.4)	15(0.5)
	Lining code	A	A	A	A
Remote Flowtube	Face-to-face length	L*2	85(3.35)		
	Outside dia.	D	44(1.73)		
Integral Flowmeter	Inner diameter of Grounding ring	ød	15(0.59)		
	Height	H1	144(5.67)		
Remote Flowtube	Max. Height	Hr	268(10.55)		
	Weight kg (lb)*3		2.4(5.3)		
Integral Flowmeter	Max. Height	Hi	306(12.03)		
	Weight kg (lb)		4.1(9.0)		

*1: When indicator code N is selected, subtract 12 mm (0.47 inch) from the value in the figure.
 In case of explosion proof type with indicator, add 5 mm (0.2 inch) to it.

*2: Depending on the selection of grounding ring code and optional code, add the following value to L (face-to-face length).

Option Code	Grounding Ring Code	S, L, H, V	P, T	N
	None	+0	+22(0.87)	-6(0.24)
	GA, GC, GD (Special Gaskets)	+2(0.08)	+24(0.94)	-

*3: When submersible type or option code DHC is selected, waterproof glands and a 30m long cable are attached. Add 9.5kg(20.9lb) to the weight in the table.

F37.EPS

● Replacement model for Earlier ADMAG or ADMAG AE, AXF025-AXF100, Wafer Type, PFA /Polyurethane Rubber Lining

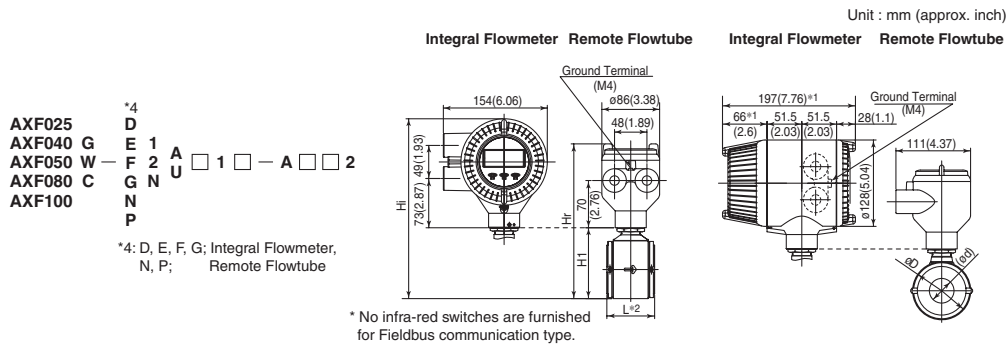

AXF025 G
 AXF040 W
 AXF050 C
 AXF080 C
 AXF100 C

*4 D E 1
 F 2 A □ 1 □ - A □ □ 2
 G N
 P

*4: D, E, F, G; Integral Flowmeter,
 N, P; Remote Flowtube

Model	Size code	025	040	050	080	100
	Size	25(1)	40(1.5)	50(2)	80(3)	100(4)
	Lining code	A,U	A,U	A,U	A,U	A,U
Remote Flowtube	Face-to-face length	L*2	93(3.66) 106(4.17) 120(4.72) 160(6.30) 180(7.09)			
	Outside dia.	øD	67.5(2.66) 86(3.39) 99(3.90) 129(5.08) 155(6.10)			
Integral Flowmeter	Inner diameter of Grounding ring	ød	27(1.06) 40(1.57) 52(2.05) 81(3.19) 98(3.86)			
	Height	H1	92(3.62) 111(4.37) 129(5.08) 157(6.18) 183(7.20)			
Remote Flowtube	Max. Height	Hr	216(8.50) 235(9.25) 253(9.96) 281(11.06) 307(12.09)			
	Weight kg (lb)*3		3.1(6.7) 3.5(7.7) 4.2(9.3) 6.4(14.1) 8.0(17.6)			
Integral Flowmeter	Max. Height	Hi	254(9.98) 273(10.73) 291(11.44) 319(12.54) 345(13.56)			
	Weight kg (lb)		4.8(10.5) 5.2(11.4) 5.9(13.1) 8.1(17.9) 9.7(21.3)			

*1: When indicator code N is selected, subtract 12 mm (0.47 inch) from the value in the figure.
 In case of explosion proof type with indicator, add 5 mm (0.2 inch) to it.

*2: Depending on the selection of grounding ring code and optional code, add the following value to L (face-to-face length).

Option Code	Grounding Ring Code	S, L, H, V	P, T	N
	None	+0	+22(0.87)	-6(0.24)
	GA, GC, GD (Special Gaskets)	+2(0.08)	+24(0.94)	-

*3: When submersible type or option code DHC is selected, waterproof glands and a 30m long cable are attached. Add 9.5kg(20.9lb) to the weight in the table.

F38.EPS

● Replacement model for Earlier ADMAG or ADMAG AE, AXF150, AXF200, Wafer Type, PFA /Polyurethane Rubber Lining

Unit : mm (approx. inch)

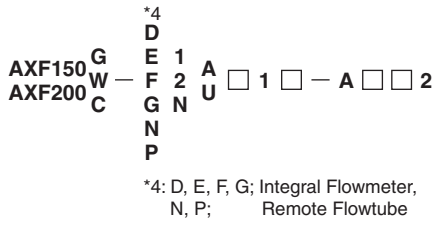
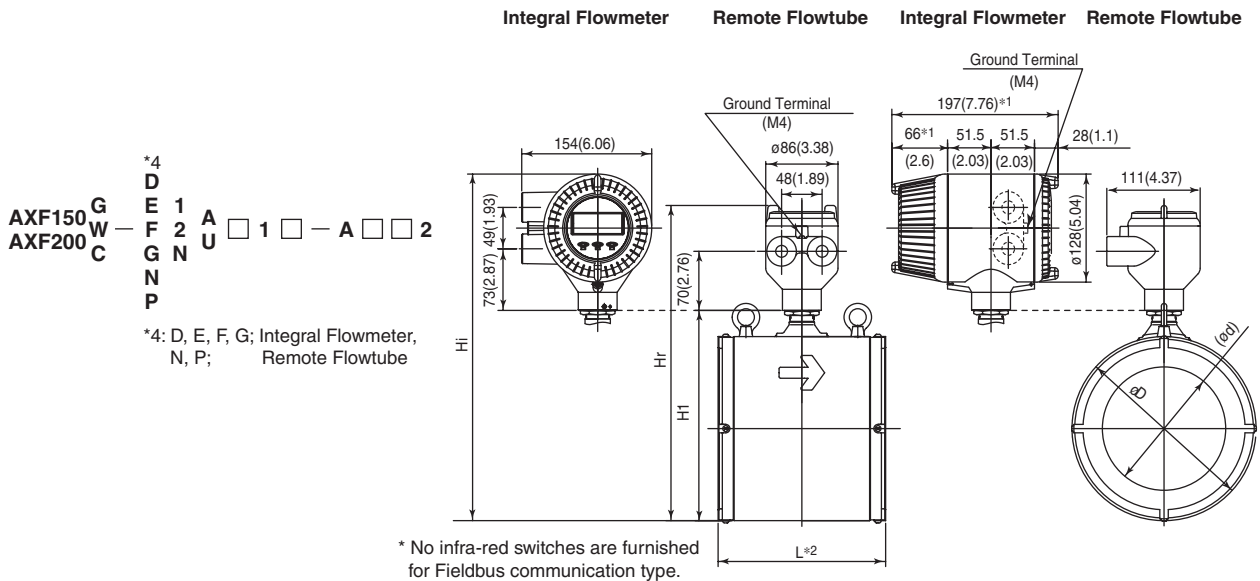

Model	Size code	150	200
	Size	150(6)	200(8)
	Lining code	A,U	A,U
Remote flowtube	Face-to-face length	L*2	230(9.06) 300(11.81)
	Outside dia.	∅D	202(7.95) 252(9.92)
Integral flowmeter	Inner diameter of Grounding ring	∅d	140.7(5.54) 188.9(7.44)
	Height	H1	243(9.57) 293(11.54)
Remote flowtube	Max. Height	Hr	367(14.45) 417(16.42)
	Weight kg (lb)*3		17.9(39.5) 26.8(59.1)
Integral flowmeter	Max. Height	Hi	405(15.93) 455(17.89)
	Weight kg (lb)		19.6(43.2) 28.5(62.8)

- *1: When indicator code N is selected, subtract 12 mm (0.47 inch) from the value in the figure.
In case of explosion proof type with indicator, add 5 mm (0.2 inch) to it.
 - *2: Depending on the selection of grounding ring code and optional code, add the following value to L (face-to-face length).
- | | | | | |
|-------------|------------------------------|------------|-----------|----------|
| Option Code | Grounding Ring Code | S, L, H, V | P, T | N |
| | None | +0 | +28(1.1) | -6(0.24) |
| | GA, GC, GD (Special Gaskets) | +2(0.08) | +30(1.18) | - |
- *3: When submersible type or option code DHC is selected, waterproof glands and a 30m long cable are attached. Add 9.5kg(20.9lb) to the weight in the table.

F39.EPS

● Replacement model for Earlier ADMAG or ADMAG AE, AXF150-AXF250, JIS/ANSI/DIN Flange Type, PFA /Polyurethane Rubber Lining

*4

D	1	C	A	□
E	2	C	D	□
F	2	C	J	□
G	N	C	G	1
N	P	C	G	1

AXF150 G — A U □ 1 □ — C C D □ 2
 AXF200 W — F 2 □ 2 □ — C C J □ 2
 AXF250 C — G N □ 2 □ — C C J □ 2
 C G 1

*4: D, E, F, G; Integral Flowmeter,
 N, P; Remote Flowtube

Unit : mm (approx. inch)

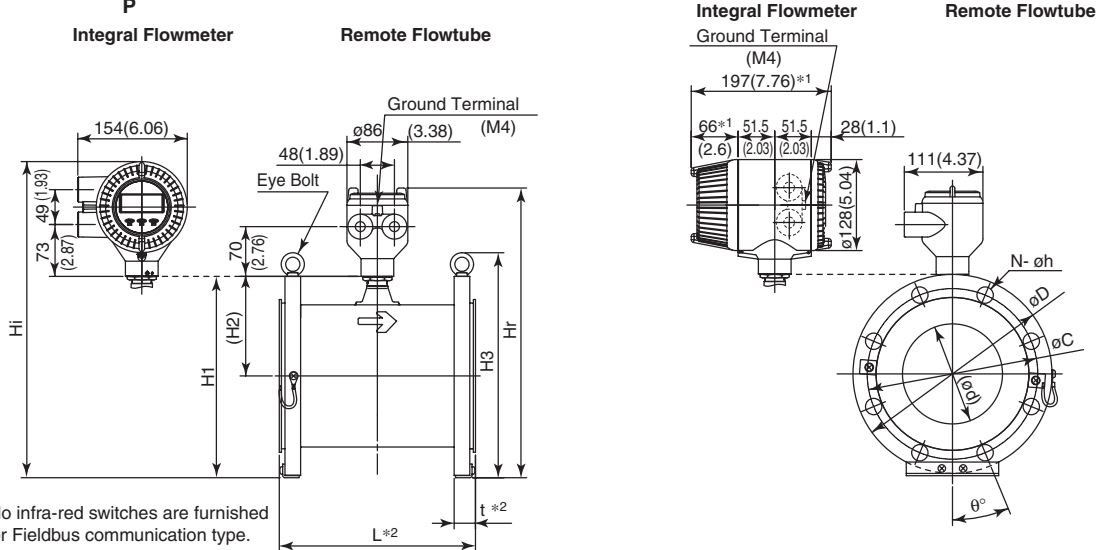

* No infra-red switches are furnished for Fieldbus communication type.

Model	Process Connection	CJ1(JIS10K)			CJ2(JIS20K)			CG1(JIS F12)			CA1(ANSI Class 150)			CA2(ANSI Class 300)			CD1(DIN PN10)			CD2(DIN PN16)					
		Size code	150	200	250	150	200	250	150	200	250	150	200	250	150	200	250	200	250	150	200	250			
	Size	150 (6)	200 (8)	250 (10)	150 (6)	200 (8)	250 (10)	150 (6)	200 (8)	250 (10)	150 (6)	200 (8)	250 (10)	150 (6)	200 (8)	250 (10)	200 (8)	250 (10)	150 (6)	200 (8)	250 (10)				
	Lining code	A,U	A,U	A,U	A,U	A,U	A,U	A,U	A,U	A,U	A,U	A,U	A,U	A,U	A,U	A,U	A,U	A,U	A,U	A,U	A,U				
Remote flowtube	Face-to-face length	L*2	270 (10.63)	340 (13.39)	430 (16.93)	270 (10.63)	340 (13.39)	430 (16.93)	270 (10.63)	340 (13.39)	430 (16.93)	270 (10.63)	340 (13.39)	430 (16.93)	270 (10.63)	340 (13.39)	430 (16.93)	270 (10.63)	340 (13.39)	430 (16.93)	270 (10.63)	340 (13.39)	430 (16.93)		
	Outside dia.	øD	280 (11.02)	330 (12.99)	400 (15.75)	305 (12.01)	350 (13.78)	430 (16.93)	290 (11.42)	342 (13.46)	410 (16.14)	279.4 (11.00)	342.9 (13.50)	406.4 (16.00)	317.5 (12.50)	381.0 (15.00)	444.5 (17.50)	340 (13.39)	395 (15.55)	285 (11.22)	340 (13.39)	405 (15.94)	340 (13.39)	405 (15.94)	
	Thickness	t*2	31 (1.22)	31 (1.22)	33 (1.30)	37 (1.46)	39 (1.54)	43 (1.69)	31 (1.22)	33 (1.30)	33 (1.30)	34.4 (1.35)	37.4 (1.47)	39.2 (1.54)	47.5 (1.87)	50.1 (1.97)	56.7 (2.23)	33 (1.30)	35 (1.38)	31 (1.22)	33 (1.30)	35 (1.38)	31 (1.22)	33 (1.30)	
	Inner diameter of Grounding ring	ød	140.7 (5.54)	188.9 (7.44)	243 (9.57)	140.7 (5.54)	188.9 (7.44)	243 (9.57)	140.7 (5.54)	188.9 (7.44)	243 (9.57)	140.7 (5.54)	188.9 (7.44)	243 (9.57)	140.7 (5.54)	188.9 (7.44)	243 (9.57)	140.7 (5.54)	188.9 (7.44)	243 (9.57)	140.7 (5.54)	188.9 (7.44)	243 (9.57)	140.7 (5.54)	
	Pitch circle dia.	øC	240 (9.45)	290 (11.42)	355 (13.98)	260 (10.24)	305 (12.01)	380 (14.96)	247 (9.72)	299 (11.77)	360 (14.17)	241.3 (9.50)	298.5 (11.75)	362.0 (14.25)	269.7 (10.62)	330.2 (13.00)	387.4 (15.25)	295 (11.61)	350 (13.78)	240 (9.45)	295 (11.61)	355 (13.98)	240 (9.45)	295 (11.61)	
	Bolt hole interval	θ°	22.5	15	15	15	15	30	22.5	22.5	22.5	22.5	22.5	15	15	15	11.25	22.5	15	22.5	15	22.5	15	15	
	Hole dia.	øh	23 (0.91)	23 (0.91)	25 (0.98)	25 (0.98)	25 (0.98)	27 (1.06)	19 (0.75)	19 (0.75)	23 (0.91)	22.4 (0.88)	22.4 (0.88)	25.4 (1.00)	22.4 (0.88)	25.4 (1.00)	28.4 (1.12)	22 (0.87)	22 (0.87)	22 (0.87)	22 (0.87)	22 (0.87)	22 (0.87)	22 (0.87)	26 (1.02)
	Number of holes	N	8	12	12	12	12	6	8	8	8	8	8	8	12	12	12	8	12	8	12	8	12	12	12
	Height	H1	284 (11.18)	334 (13.15)	400 (15.75)	297 (11.69)	344 (13.54)	415 (16.34)	289 (11.38)	340 (13.39)	405 (15.94)	284 (11.18)	340 (13.39)	403 (15.87)	303 (11.93)	360 (14.17)	422 (16.61)	339 (13.35)	397 (15.63)	287 (11.30)	339 (13.35)	402 (15.83)	287 (11.30)	339 (13.35)	402 (15.83)
		H2	141 (5.55)	166 (6.54)	197 (7.76)	141 (5.55)	166 (6.54)	197 (7.76)	141 (5.55)	166 (6.54)	197 (7.76)	141 (5.55)	166 (6.54)	197 (7.76)	141 (5.55)	166 (6.54)	197 (7.76)	141 (5.55)	166 (6.54)	197 (7.76)	141 (5.55)	166 (6.54)	197 (7.76)	141 (5.55)	166 (6.54)
H3		325 (12.80)	375 (14.76)	454 (17.87)	350 (13.78)	395 (15.55)	484 (19.06)	335 (13.19)	387 (15.24)	464 (18.27)	324 (12.76)	387 (15.24)	460 (18.11)	362 (14.25)	426 (16.77)	499 (19.65)	463 (18.23)	521 (20.51)	385 (15.16)	449 (17.68)	330 (12.99)	385 (15.16)	459 (18.07)	330 (12.99)	459 (18.07)
Remote flowtube	Max. Height	Hr	408 (16.06)	458 (18.03)	524 (20.63)	421 (16.57)	468 (18.43)	539 (21.22)	413 (16.26)	464 (18.27)	529 (20.83)	408 (16.06)	464 (18.27)	527 (20.75)	427 (16.81)	484 (19.06)	546 (21.50)	463 (18.23)	521 (20.51)	411 (16.18)	463 (18.23)	526 (20.71)	411 (16.18)	463 (18.23)	
	Weight kg (lb)*3		29 (63.9)	39 (86.0)	64 (141.1)	38.3 (84.4)	53.6 (118.2)	92.5 (203.9)	31.1 (68.6)	44.6 (98.3)	67.4 (148.6)	32.1 (70.7)	50.9 (112.2)	77.4 (170.6)	53.7 (118.4)	80.5 (177.5)	127.0 (279.9)	44.2 (97.5)	67.0 (147.7)	29.9 (65.8)	43.6 (96.2)	68.8 (151.7)	29.9 (65.8)	43.6 (96.2)	
Integral flowmeter	Max. Height	Hi	446 (17.56)	496 (19.53)	562 (22.13)	459 (18.07)	506 (19.92)	577 (22.72)	451 (17.76)	502 (19.76)	567 (22.32)	446 (17.56)	502 (19.76)	565 (22.24)	465 (18.31)	522 (20.55)	584 (22.99)	501 (19.72)	559 (22.01)	449 (17.68)	501 (19.72)	564 (22.20)	449 (17.68)	501 (19.72)	
	Weight kg (lb)		30.7 (67.7)	40.7 (89.7)	65.7 (144.8)	40.0 (88.2)	55.3 (121.9)	94.2 (207.7)	32.8 (72.3)	46.3 (102.1)	69.1 (152.3)	33.8 (74.4)	52.6 (115.9)	79.1 (174.4)	55.4 (122.1)	82.2 (181.2)	128.7 (283.6)	45.9 (101.2)	68.7 (151.5)	31.6 (69.6)	45.3 (100.0)	70.5 (155.5)	31.6 (69.6)	45.3 (100.0)	

*1: When indicator code N is selected, subtract 12 mm (0.47 inch) from the value in the figure.

In case of explosion proof type with indicator, add 5 mm (0.2 inch) to it.

*2: Depending on the selection of grounding ring code and optional code, add the following value to "L" (face-to-face length) and "t" (thickness of flange).

Nominal Size: 150, 200 mm							
Grounding Ring Code	L	t	L	t	L	t	
	S, L, H, V			P, T		N	
Option Code	None	+0	+0	+28(1.1)	+14(0.55)	-6(0.24)	-3(0.12)
	GA, GC, GD (Special Gaskets)	+2(0.08)	+1(0.04)	+30(1.81)	+15(0.59)	-	-

Nominal Size: 250 mm				
Grounding Ring Code	L	t	L	t
	S, L, H, V			N
Option Code is "None"	+0	+0	-6(0.24)	-3(0.12)

*3: When submersible type or option code DHC is selected, waterproof glands and a 30m long cable are attached. Add 9.5kg(20.9lb) to the weight in the table.

● Flameproof Packing Adapter for TIIS Flameproof Type (Optional code G12 or G11)

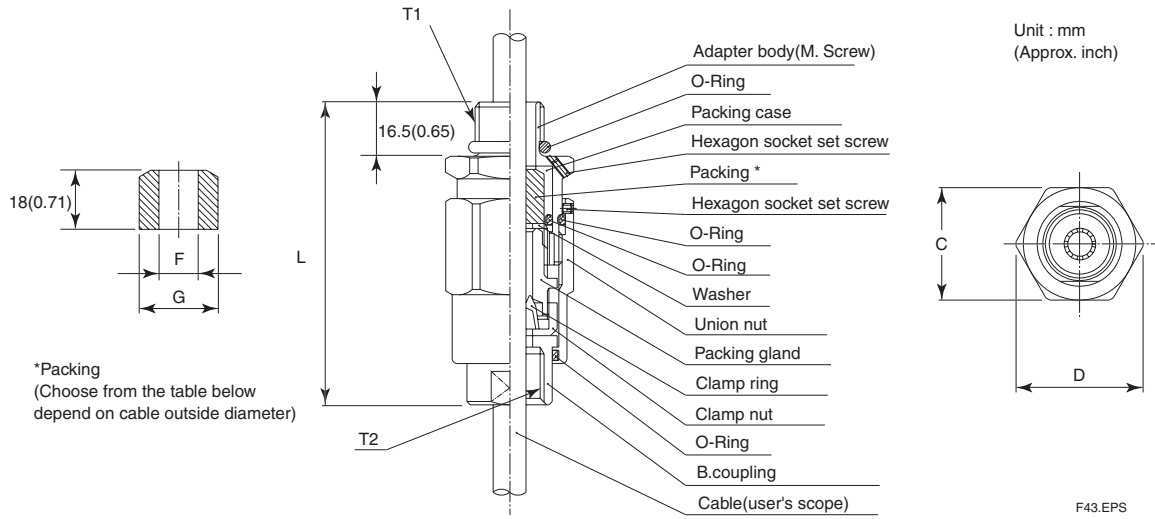

Nominal diameter		Dimension			Cable outer diameter	Packing diameter		Identification mark	Weight kg (lb)	Parts No.
T1	T2	C	D	L		F	G			
G 1/2	G 1/2	35 (1.38)	39 (1.54)	94.5 (3.72)	ø8.0 to ø10.0 (0.31 to 0.39)	ø10.0(0.39)	ø20.0	16 8-10	0.26 (0.57)	G9601AM*
					ø10.0 to ø12.0 (0.39 to 0.47)	ø12.0(0.47)	(0.79)	16 10-12		

*: G 11: 1 unit T31.EPS
G 12: 2 units

● Unless otherwise specified, difference in the dimensions are refer to the following table.

General tolerance in the dimensional outline drawing.

Unit : mm (approx.inch)

Category of basic dimension		Tolerance	Category of basic dimension		Tolerance
Above	Equal or below		Above	Equal or below	
	3 (0.12)	±0.7 (±0.03)	500 (19.69)	630 (24.80)	±5.5 (±0.22)
3 (0.12)	6 (0.24)	±0.9 (±0.04)	630 (24.80)	800 (31.50)	±6.25 (±0.25)
6 (0.24)	10 (0.39)	±1.1 (±0.04)	800 (31.50)	1000 (39.37)	±7.0 (±0.28)
10 (0.39)	18 (0.71)	±1.35 (±0.05)	1000 (39.37)	1250 (49.21)	±8.25 (±0.32)
18 (0.71)	30 (1.18)	±1.65 (±0.06)	1250 (49.21)	1600 (62.99)	±9.75 (±0.38)
30 (1.18)	50 (1.97)	±1.95 (±0.08)	1600 (62.99)	2000 (78.74)	±11.5 (±0.45)
50 (1.97)	80 (3.15)	±2.3 (±0.09)	2000 (78.74)	2500 (98.43)	±14.0 (±0.55)
80 (3.15)	120 (4.72)	±2.7 (±0.11)	2500 (98.43)	3150 (124.02)	±16.5 (±0.65)
120 (4.72)	180 (7.09)	±3.15 (±0.12)			
180 (7.09)	250 (9.84)	±3.6 (±0.14)			
250 (9.84)	315 (12.40)	±4.05 (±0.16)			
315 (12.40)	400 (15.75)	±4.45 (±0.18)			
400 (15.75)	500 (19.69)	±4.85 (±0.19)			

Remarks: The numeric is based on criteria of tolerance class IT18 in JIS B 0401.

■ SIZING DATA (Measurable flow velocity is from 0 m/s.)

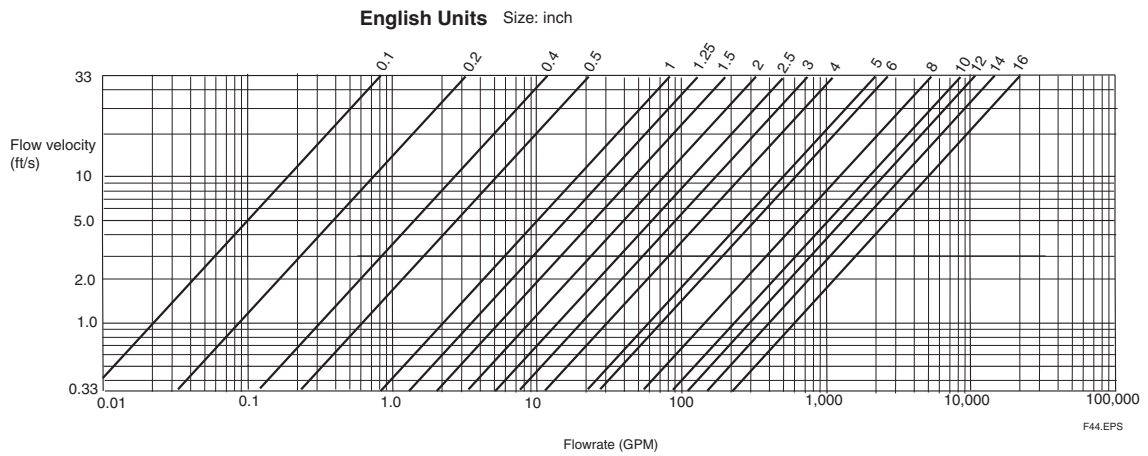
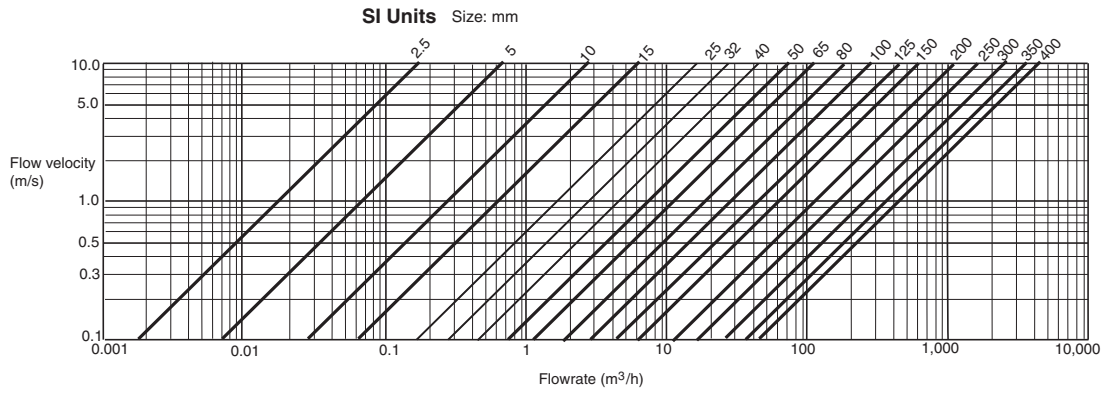

* Measurable flow velocity is from 0 m/s.

ORDERING INFORMATION “◇”

Note 1: When ordering, the span flow rate, unit, output pulse weight, and totalizer display pulse weight can be specified. These parameters will then be set before shipment.
 In the case of remote type, please specify combination information of flowtube and converter. These parameters will be set in the combined converter.
 When ordering of a flowtube alone or a converter alone, these parameters cannot specify. Custom configuration request is necessary for setting these parameters out of regular setting range.

Note 2: Some options, if ordered, require the relevant specifications to be input when ordering.

1. Model, specification and option codes.
2. Combined use (when ordering a remote flowtube)
 Model, suffix code, optional code, and tag number (if specified) of a converter for combined use.
 For detail, refer to GS 01E20C01-01E or GS 01E20C02-01E.
3. Tag number
 Each tag number can be specified in up to 16 characters in a combination of letters (capital or small letters), numbers, “-” and “.”.
 For HART protocol, up to 8 characters can be specified. If specified, the tag number is inscribed on the product’s name plate and tag plate (if optional code SCT is selected). If the product is an integral flowmeter, the tag number is also set into the memory of its converter. If the user wishes to change only the tag number to be set into a converter’s memory, specify the software tag. If a tag number is not specified, the tag number is set as a blank.
4. Span flow rates and units
 Span flow rate can be specified the numeric within the value of 0.0001 to 32000.
 And it can be up to five digits, to a maximum of 32000 ignoring the decimal point.
 And a fraction is limited to the fourth decimal place. Integral flowmeter are set to the first range in the forward direction. Remote flowtube are set to the first range in the forward direction of the converter (AXFA11 or AXFA14) with which they are to be combined.
 A span flow rate and its unit must be specified when the Mass Unit Setting (optional code MU) or Five-point Calibration in User-specified Span (optional code SC) is specified.
 If a span flow rate and its unit are not specified, the relevant product is delivered with the setting at 1 m/s (3.3 ft/s).

5. Output pulse weight
 If specified, a span flow rate must be set first, and then volume per pulse must be set.
 It can be specified numerically within the value from 0.0001 to 32000, and its unit must be specified in the same unit as the span flow rate.
 (Example: When “m³” is selected as “Span Flow Rate”, specify “10 m³/p” as pulse weight unit.)
 Unless specified, the relevant product is delivered with the setting at 0 pulse/second.
6. Totalizer display pulse weight
 If specified, a span flow rate must be set first, and then volume per totalization pulse count must be set.
 It can be specified numerically within the value from 0.0001 to 32000, and its unit must be specified in the same unit as the span flow rate.
 (Example: when “m³” is selected as “Span Flow Rate”, specify “10 m³/p” as pulse weight unit.)
 Unless specified, the relevant product is delivered with the setting at 0 pulse/second.
7. Fluid name

RELATED INSTRUMENTS

- Calibrator for Magnetic Flowmeter (AM012):
 GS 1E6K2-E
- BT200 BRAIN TERMINAL: GS 01C00A11-00EN
- AXFA11G Magnetic Flowmeter Remote Converter:
 GS 01E20C01-01E
- AXFA14G/C Magnetic Flowmeter Remote Converter:
 GS 01E20C02-01E
- AXF FOUNDATION Fieldbus Communication Type Magnetic Flowmeter: GS 01E20F02-01E
- AXF PROFIBUS PA Communication Type Magnetic Flowmeter: GS 01E20F12-01E
- FieldMate: GS 01R01A01-01E

REFERENCE

‘ADMAG’, ‘AXF’, ‘ADMAG AXF’, ‘BRAIN TERMINAL’ and ‘FieldMate’ are registered trademarks of Yokogawa Electric Corporation.
 Company names and product names used in this material are registered trademarks or trademarks of their respective owners.