

Scope of application

- Precise flow rate measurement of fluids and gases, multi-phase media and media with specific gas content using the Coriolis principle.
- Direct measurement of mass flow and density independent of the medium's physical properties, such as density, viscosity and homogeneity
- Concentration measurement of solutions, suspensions and emulsions
- Medium temperatures of $-70 - 350\text{ }^{\circ}\text{C}$ ($-94 - 662\text{ }^{\circ}\text{F}$)
- Process pressures up to 100 bar
- EN, ASME, JPI or JIS standard flange process connections up to three nominal diameters per meter size
- Connection to common process control systems, such as via HART7 or Modbus
- Hazardous area approvals: IECEx, ATEX, FM (USA/Canada), NEPSI, INMETRO, PESO
- Safety-related applications: PED per AD 2000 Code, SIL 2, secondary containment up to 120 bar
- Marine type approval: DNV GL

Advantages and benefits

- Inline measurement of several process variables, such as mass, density and temperature
- Adapterless installation due to multi-size flange concept
- No straight pipe runs at inlet or outlet required
- Fast and uncomplicated commissioning and operation of the flow meter
- Maintenance-free operation
- Functions that can be activated subsequently (feature on demand)
- Total health check: Self-monitoring of the entire flow meter, including accuracy
- Maximum accuracy due to calibration facility accredited according to ISO/IEC 17025 (for option K5)
- Self-draining installation
- Immune to vibrations thanks to the counterbalanced dual tube flow meter and box-in-box design

Table of contents

1 Introduction	5
1.1 Applicable documents.....	5
1.2 Product overview	6
2 Measuring principle and flow meter design	7
2.1 Measuring principle.....	7
2.2 Flow meter	9
3 Application and measuring ranges	13
3.1 Measured quantities	13
3.2 Measuring range overview.....	14
3.3 Mass flow	14
3.4 Volume flow	15
3.5 Pressure loss	15
3.6 Density.....	15
3.7 Temperature	15
4 Accuracy	16
4.1 Overview.....	16
4.2 Zero point stability of the mass flow.....	17
4.3 Mass flow accuracy	17
4.3.1 Sample calculation for liquids	18
4.3.2 Sample calculation for gases	19
4.4 Accuracy of density.....	20
4.4.1 For liquids	20
4.4.2 For gases	20
4.5 Accuracy of mass flow and density according to the MS code.....	21
4.5.1 For liquids	21
4.5.2 For gases	21
4.6 Volume flow accuracy.....	22
4.6.1 For liquids	22
4.6.2 For gases	22
4.7 Accuracy of temperature.....	22
4.8 Repeatability	23
4.9 Calibration conditions	24
4.9.1 Mass flow calibration and density adjustment.....	24
4.9.2 Density calibration.....	24
4.10 Process pressure effect.....	24
4.11 Process temperature effect.....	25
5 Operating conditions	27
5.1 Location and position of installation.....	27
5.1.1 Sensor installation position	27
5.2 Installation instructions	28
5.3 Process conditions.....	28
5.3.1 Medium temperature range.....	28
5.3.2 Density	29
5.3.3 Pressure.....	29

5.3.4	Mass flow	31
5.3.5	Effect of temperature on accuracy	32
5.3.6	Insulation and heat tracing	32
5.3.7	Secondary containment	33
5.4	Ambient conditions	33
5.4.1	Allowed ambient temperature for sensor	34
5.4.2	Temperature specification in hazardous areas	35
6	Mechanical specification	39
6.1	Design	39
6.2	Material	40
6.2.1	Material wetted parts	40
6.2.2	Non-wetted parts	40
6.3	Process connections, dimensions and weights of sensor	41
6.4	Transmitter dimensions and weights	53
7	Transmitter specification	55
7.1	Inputs and outputs	56
7.1.1	Output signals	57
7.1.2	Input signals	63
7.2	Power supply	64
7.3	Cable specification	64
8	Approvals and declarations of conformity	65
9	Ordering information	71
9.1	Overview MS code Supreme 34	71
9.2	Overview MS code Supreme 36	74
9.3	Overview MS code Supreme 38	77
9.4	Overview MS code Supreme 39	80
9.5	Overview options	83
9.6	MS code	88
9.6.1	Transmitter	88
9.6.2	Sensor	88
9.6.3	Meter size	89
9.6.4	Material wetted parts	89
9.6.5	Process connection size	89
9.6.6	Process connection type	90
9.6.7	Sensor housing material	90
9.6.8	Medium temperature range	91
9.6.9	Mass flow and density accuracy	91
9.6.10	Design and housing	92
9.6.11	Ex approval	93
9.6.12	Cable entries	93
9.6.13	Inputs and outputs	94
9.6.14	Display	96
9.7	Options	97
9.7.1	Connecting cable type and length	97
9.7.2	Additional nameplate information	98
9.7.3	Presetting of customer parameters	98

Table of contents

9.7.4	Concentration and petroleum measurement.....	98
9.7.5	Insulation and heat tracing.....	100
9.7.6	Certificates.....	101
9.7.7	Country-specific delivery.....	103
9.7.8	Rupture disc.....	103
9.7.9	Tube health check.....	103
9.7.10	Transmitter housing rotated 180°.....	104
9.7.11	Measurement of heat quantity.....	104
9.7.12	Marine Approval.....	105
9.7.13	Customer specific special product manufacture.....	105
9.8	Ordering Instructions.....	106

1 Introduction

1.1 Applicable documents

For Ex approval specification, refer to the following documents:

- Ex instruction manual ATEX IM 01U10X01-00_ _-R
- Ex instruction manual IECEx IM 01U10X02-00_ _-R
- Ex instruction manual FM IM 01U10X03-00_ _-R
- Ex instruction manual INMETRO IM 01U10X04-00_ _-R
- Ex instruction manual PESO IM 01U10X05-00_ _-R

Other applicable User's manuals:







- Protection of Environment (Use in China only) IM 01A01B01-00ZH-R

1.2 Product overview

Rotamass Coriolis flow meters are available in various product families distinguished by their applications. Each product family includes several product alternatives and additional device options that can be selected.

The following overview serves as a guide for selecting products.

Overview of Rotamass product families

<p>Rotamass Nano</p>		<p>For low flow rate applications Meter sizes: Nano 06, Nano 08, Nano 10, Nano 15, Nano 20 Connection sizes: <ul style="list-style-type: none"> ▪ DN15, DN25, DN40 ▪ 1/4", 1/2", 3/8", 3/4", 1", 1 1/2" Maximum mass flow: 1.5 t/h (55 lb/min)</p>
<p>Rotamass Prime</p>		<p>Versatility with low costs for the operator Meter sizes: Prime 25, Prime 40, Prime 50, Prime 80 Connection sizes: <ul style="list-style-type: none"> ▪ DN15, DN25, DN40, DN50, DN80 ▪ 3/8", 1/2", 3/4", 1", 1 1/2", 2", 2 1/2", 3" Maximum mass flow: 76 t/h (2800 lb/min)</p>
<p>Rotamass Supreme</p>		<p>Excellent performance under demanding conditions Meter sizes: Supreme 34, Supreme 36, Supreme 38, Supreme 39 Connection sizes: <ul style="list-style-type: none"> ▪ DN15, DN25, DN40, DN50, DN80, DN100, DN125 ▪ 3/8", 1/2", 3/4", 1", 1 1/2", 2", 2 1/2", 3", 4", 5" Maximum mass flow: 170 t/h (6200 lb/min)</p>
<p>Rotamass Intense</p>		<p>For high process pressure applications Meter sizes: Intense 34, Intense 36, Intense 38 Connection sizes: <ul style="list-style-type: none"> ▪ 1/2", 1", 2" Maximum mass flow: 50 t/h (1800 lb/min)</p>
<p>Rotamass Hygienic</p>		<p>For food, beverage and pharmaceutical applications Meter sizes: Hygienic 25, Hygienic 40, Hygienic 50, Hygienic 80 Connection sizes: <ul style="list-style-type: none"> ▪ DN25, DN40, DN50, DN65, DN80 ▪ 1", 1 1/2", 2", 2 1/2", 3" Maximum mass flow: 76 t/h (2800 lb/min)</p>
<p>Rotamass Giga</p>		<p>For high flow rate applications Meter sizes: Giga 1F, Giga 2H Connection sizes: <ul style="list-style-type: none"> ▪ DN100, DN125, DN150, DN200 ▪ 4", 5", 6", 8" Maximum mass flow: 600 t/h (22000 lb/min)</p>

2 Measuring principle and flow meter design

2.1 Measuring principle

The measuring principle is based on the generation of Coriolis forces. For this purpose, a driver system (E) excites the two measuring tubes (M1, M2) in their first resonance frequency. Both pipes vibrate inversely phased, similar to a resonating tuning fork.

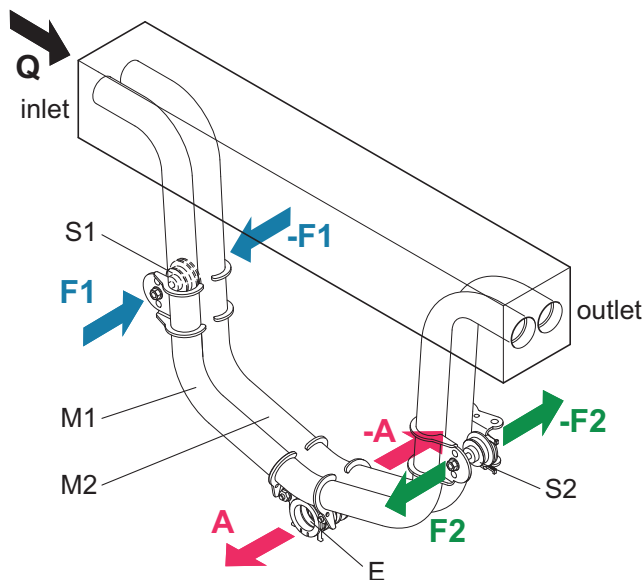

Fig. 1: Coriolis principle

M1, M2	Measuring tubes	E	Driver system
S1, S2	Pick-offs	A	Direction of measuring tube vibration
F1, F2	Coriolis forces	Q	Direction of medium flow

Mass flow

The medium flow through the vibrating measuring tubes generates Coriolis forces (F_1 , $-F_1$ and F_2 , $-F_2$) that produce positive or negative values for the tubes on the inflow or outflow side. These forces are directly proportional to the mass flow and result in deformation (torsion) of the measuring tubes.

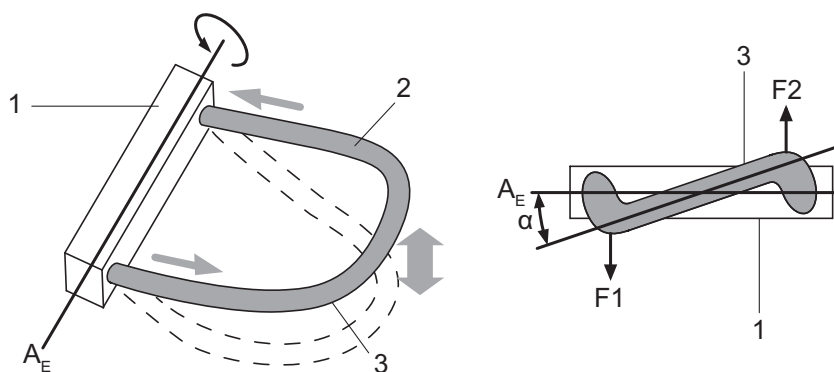

Fig. 2: Coriolis forces and measuring tube deformation

1	Measuring tube mount	A_E	Rotational axis
2	Medium	F_1, F_2	Coriolis forces
3	Measuring tube	α	Torsion angle

The small deformation overlying the fundamental vibration is recorded by means of pick-offs (S1, S2) attached at suitable measuring tube locations. The resulting phase shift $\Delta\phi$ between the output signals of pick-offs S1 and S2 is proportional to the mass flow. The output signals generated are further processed in a transmitter.

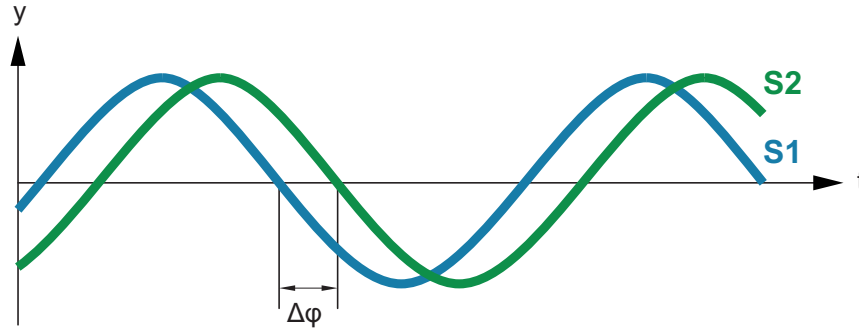

Fig. 3: Phase shift between output signals of S1 and S2 pick-offs

$$\Delta\phi \sim F_c \sim \frac{dm}{dt}$$

- $\Delta\phi$ Phase shift
- m Dynamic mass
- t Time
- dm/dt Mass flow
- F_c Coriolis force

Density measurement

Using a driver and an electronic regulator, the measuring tubes are operated in their resonance frequency f . This resonance frequency is a function of measuring tube geometry, material properties and the mass of the medium covibrating in the measuring tubes. Altering the density and the attendant mass will alter the resonance frequency. The transmitter measures the resonance frequency and calculates density from it according to the formula below. Device-dependent constants are determined individually during calibration.

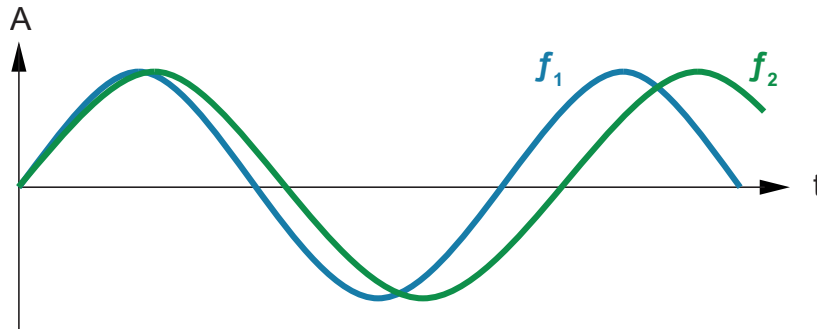

Fig. 4: Resonance frequency of measuring tubes

- A Measuring tube displacement
- f_1 Resonance frequency with medium 1
- f_2 Resonance frequency with medium 2

$$\rho = \frac{\alpha}{f^2} + \beta$$

- ρ Medium density
- f Resonance frequency of measuring tubes
- α, β Device-dependent constants

Temperature measurement

The measuring tube temperature is measured in order to compensate for the effects of temperature on the flow meter. This temperature approximately equals the medium temperature and is made available as a measured quantity at the transmitter as well.

2.2 Flow meter

The Rotamass Coriolis flow meter consists of:

- Sensor
- Transmitter

In the integral type, sensor and transmitter are firmly connected.

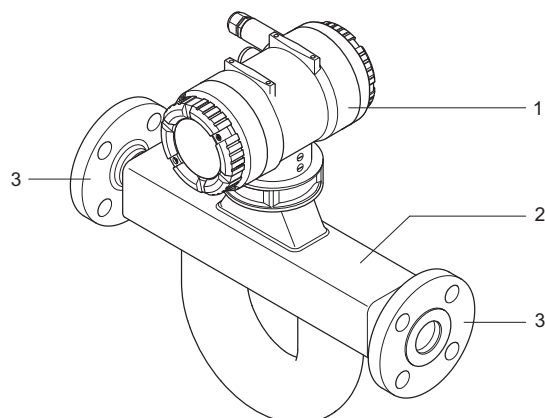

Fig. 5: Configuration of the Rotamass integral type

- | | |
|---|---------------------|
| 1 | Transmitter |
| 2 | Sensor |
| 3 | Process connections |

When the remote type is used, sensors and transmitters are linked via connecting cable. As a result, sensor and transmitter can be installed in different locations.

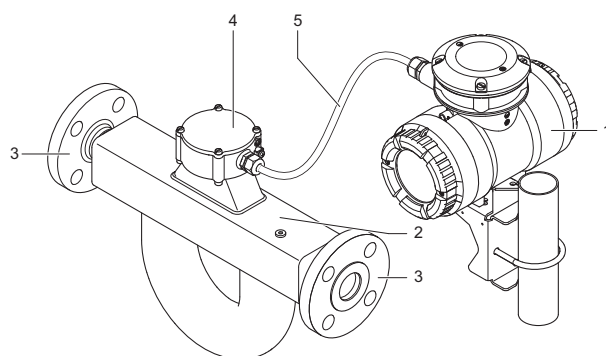

Fig. 6: Configuration of the Rotamass remote type

- | | | | |
|---|---------------------|---|---------------------|
| 1 | Transmitter | 4 | Sensor terminal box |
| 2 | Sensor | 5 | Connecting cable |
| 3 | Process connections | | |

When the remote type is used, sensors and transmitters are linked via connecting cable. As a result, sensor and transmitter can be installed in different locations.

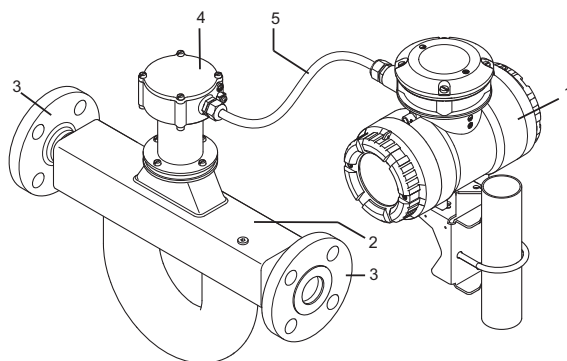

Fig. 7: Configuration of the Rotamass remote type - long neck

- | | | | |
|---|---------------------|---|---------------------|
| 1 | Transmitter | 4 | Sensor terminal box |
| 2 | Sensor | 5 | Connecting cable |
| 3 | Process connections | | |

General specifications

All available properties of the Rotamass Coriolis flow meter are specified by means of a model code (MS code).

One MS code position may include several characters depicted by means of dashed lines.

The positions of the MS code relevant for the respective properties are depicted and highlighted in blue. Any values that might occupy these MS code positions are subsequently explained.

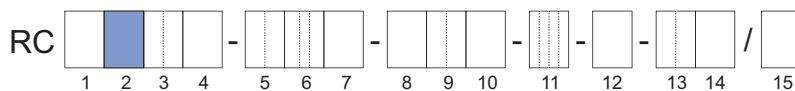

Fig. 8: Highlighted MS code positions

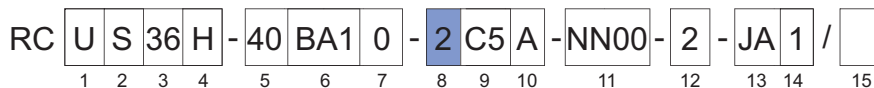
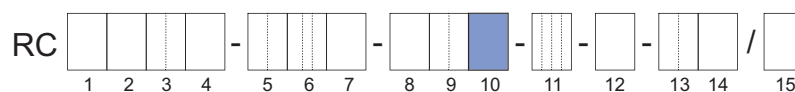

Fig. 9: Example of a completed MS code

A complete description of the MS code is included in the chapter entitled *Ordering information* [▶ 71].

Type of design



Position 10 of the MS code defines whether the integral type or the remote type is used. It specifies further flow meter properties, such as the transmitter coating, see *Design and housing* [▶ 92].

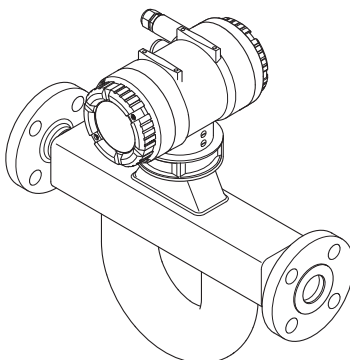
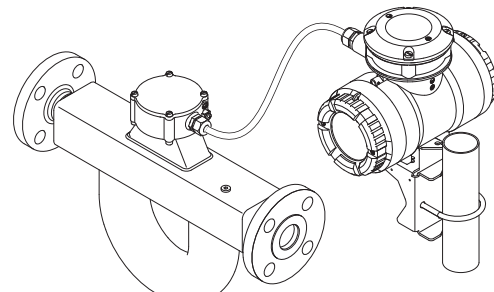
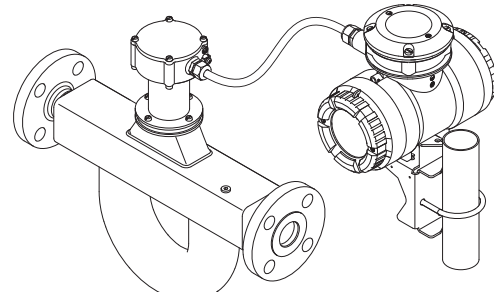

Flow meter	MS code Position 10
<p>Integral type</p> 	0, 2
<p>Remote type</p> 	A, E, J
<p>Remote type - long neck</p> 	B, F, K

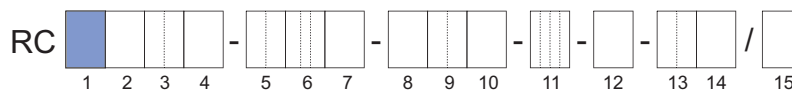
Transmitter overview Two different transmitters are available that differ in their functional scope.



Transmitter	Properties	MS code Position 1
<p>Essential</p> 	<ul style="list-style-type: none"> ▪ Down to 0.15 % mass flow accuracy for liquids ▪ Down to 0.75 % mass flow accuracy for gases ▪ Down to 4 g/l (0.25 lb/ft³) accuracy for density ▪ Diagnostic functions ▪ HART communication ▪ Modbus communication ▪ Data backup on microSD card 	E
<p>Ultimate</p> 	<ul style="list-style-type: none"> ▪ Down to 0.1 % mass flow accuracy for liquids ▪ Down to 0.5 % mass flow accuracy for gases ▪ Down to 0.5 g/l (0.03 lb/ft³) accuracy for density ▪ Diagnostic functions ▪ HART communication ▪ Modbus communication ▪ Special functions for special applications, such as dynamic pressure compensation ▪ Data backup on microSD card 	U

3 Application and measuring ranges

3.1 Measured quantities

The Rotamass Coriolis flow meter can be used to measure the following media:

- Liquids
- Gases
- Mixtures, such as emulsions, suspensions, slurries

Possible limitations applying to measurement of mixtures must be checked with the responsible Yokogawa sales organization.

The following variables can be measured using the Rotamass:

- Mass flow
- Density
- Temperature

Based on these measured quantities, the transmitter also calculates:

- Volume flow
- Partial component concentration of a two-component mixture
- Partial component flow rate of a mixture consisting of two components (net flow)

In this process, the net flow is calculated based on the known partial component concentration and the overall flow.

3.2 Measuring range overview

	Supreme 34	Supreme 36	Supreme 38	Supreme 39	
Mass flow range					
Typical connection size	DN15, ½"	DN25, 1"	DN40, 1½"	DN80, 3"	
Q _{nom}	3 t/h (110 lb/min)	10 t/h (370 lb/min)	32 t/h (1200 lb/min)	100 t/h (3700 lb/min)	[▶ 14]
Q _{max}	5 t/h (180 lb/min)	17 t/h (620 lb/min)	50 t/h (1800 lb/min)	170 t/h (6200 lb/min)	
Maximum volume flow					
(Water)	5 m³/h (42 barrel/h)	17 m³/h (140 barrel/h)	50 m³/h (420 barrel/h)	170 m³/h (1400 barrel/h)	[▶ 15]
Range of medium density					
	0 – 5 kg/l (0 – 310 lb/ft³)			0 – 2 kg/l (0 – 120 lb/ft³)	[▶ 15]
Medium temperature range					
Standard ¹⁾	-70 – 150 °C (-94 – 302 °F)				[▶ 28]
Mid-range	-70 – 230 °C (-94 – 446 °F)				
High	0 – 350 °C (32 – 662 °F)				

¹⁾ May vary depending on the design.

Q_{nom} - Nominal mass flow

Q_{max} - Maximum mass flow

The nominal mass flow Q_{nom} is defined as the mass flow of water (temperature: 20 °C) at 1 bar pressure loss along the flow meter.

3.3 Mass flow

For Rotamass Supreme the following meter sizes to be determined using the *MS code* [▶ 88] are available.

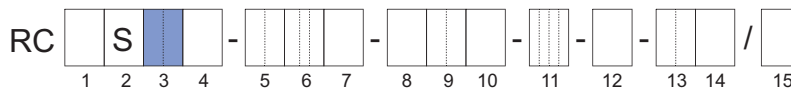

Mass flow of liquids

Meter size	Typical connection size	Q _{nom} in t/h (lb/min)	Q _{max} in t/h (lb/min)	MS code Position 3
Supreme 34	DN15, ½"	3 (110)	5 (180)	34
Supreme 36	DN25, 1"	10 (370)	17 (620)	36
Supreme 38	DN40, 1½"	32 (1200)	50 (1800)	38
Supreme 39	DN80, 3"	100 (3700)	170 (6200)	39

Mass flow of gases

When using the Rotamass for measuring the flow of gases, the mass flow is usually limited by the pressure loss generated and the maximum flow velocity. Since these depend heavily on the application, please contact the local Yokogawa sales organization.

3.4 Volume flow

Volume flow of liquids (water at 20 °C)

Meter size	Volume flow (at 1 bar pressure loss) in m ³ /h (barrel/h)	Maximum volume flow in m ³ /h (barrel/h)
Supreme 34	3 (25)	5 (42)
Supreme 36	10 (84)	17 (140)
Supreme 38	32 (270)	50 (420)
Supreme 39	100 (840)	170 (1400)

Volume flow of gases

When using the Rotamass for measuring the flow of gases, the flow rate is usually limited by the pressure loss generated and the maximum flow velocity. Since these depend heavily on the application, please contact the local Yokogawa sales organization.

3.5 Pressure loss

The pressure loss along the flow meter is heavily dependent on the application. The pressure loss of 1 bar at nominal mass flow Q_{nom} also applies to water and is considered the reference value.

3.6 Density

Meter size	Measuring range of density
Supreme 34	0 – 5 kg/l (0 – 310 lb/ft ³)
Supreme 36	
Supreme 38	
Supreme 39	0 – 2 kg/l (0 – 120 lb/ft ³)

Rather than being measured directly, density of gas is usually calculated using its reference density, process temperature and process pressure.

3.7 Temperature

The temperature measuring range is limited by the allowed process temperature, see *Medium temperature range* [28].

Maximum measuring range: -70 – 350 °C (-94 – 662 °F)

4 Accuracy

In this chapter, maximum deviations are indicated as absolute values.



All accuracy data are given in \pm values.

4.1 Overview

Achievable accuracies for liquids

The value D_{flat} specified for accuracy of mass flow applies for flow rates exceeding the mass flow limit Q_{flat} . If the flow rate is less than Q_{flat} , other effects have to be considered.

The following values are achieved at calibration conditions when the device is delivered, see *Calibration conditions* [▶ 24]. Depending on the product version selected, specifications may not be as accurate, see *Mass flow and density accuracy* [▶ 91].

Measured quantity		Accuracy for transmitters	
		Essential	Ultimate
Mass flow ¹⁾	Accuracy ²⁾ D_{flat}	0.15 % of measured value	0.1 % of measured value
	Repeatability	0.08 % of measured value	0.05 % of measured value
Volume flow (water) ¹⁾	Accuracy ²⁾ D_v	0.43 % of measured value	0.12 % of measured value
	Repeatability	0.22 % of measured value	0.06 % of measured value
Density	Accuracy ²⁾	4 g/l (0.25 lb/ft ³)	0.5 g/l (0.03 lb/ft ³)
	Repeatability	2 g/l (0.13 lb/ft ³)	0.3 g/l (0.02 lb/ft ³)
Temperature	Accuracy ²⁾	0.5 °C (0.9 °F)	0.5 °C (0.9 °F)

¹⁾ Based on the measured values of the pulse output. Includes the combined effects of repeatability, linearity and hysteresis.

²⁾ Best accuracy per transmitter type

The connecting cable may influence the accuracy. The values specified are valid for connecting cables \leq 30 m (98.4 ft) long.

Achievable accuracies for gases

Measured quantity		Accuracy for transmitters	
		Essential	Ultimate
Mass flow / standard volume flow ¹⁾	Accuracy ²⁾ D_{flat}	0.75 % of measured value	0.5 % of measured value
	Repeatability	0.6 % of measured value	0.4 % of measured value
Temperature	Accuracy ²⁾	0.5 °C (0.9 °F)	0.5 °C (0.9 °F)

¹⁾ Based on the measured values of the pulse output. Includes the combined effects of repeatability, linearity and hysteresis.

²⁾ Best mass flow accuracy per transmitter type

In the event of medium temperature jumps, a delay is to be expected in the temperature being displayed due to low heat capacity and heat conductivity of gases.

The connecting cable may influence the accuracy. The values specified are valid for connecting cables \leq 30 m (98.4 ft) long.

4.2 Zero point stability of the mass flow

In case of no flow, the maximum measured flow rate is called *Zero point stability*. Zero point values are shown in the table below.

Meter size	Zero point stability Z in kg/h (lb/min)
Supreme 34	0.15 (0.0055)
Supreme 36	0.5 (0.018)
Supreme 38	1.6 (0.059)
Supreme 39	5 (0.18)

4.3 Mass flow accuracy

Above mass flow Q_{flat} , maximum deviation is constant and referred to as D_{flat} . It depends on the product version and can be found in the tables in chapter *Accuracy of mass flow and density according to the MS code* [21].

Use the following formulas to calculate the maximum deviation D :

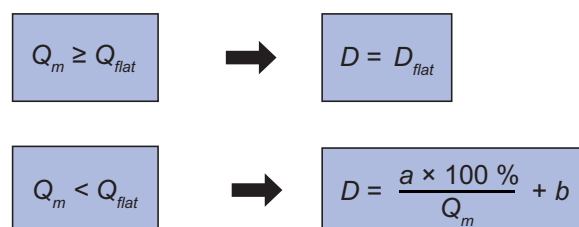

D Maximum deviation in %

Q_m Mass flow in kg/h

D_{flat} Maximum deviation for high flow rates in %

Q_{flat} Mass flow value above which D_{flat} applies, in kg/h

a, b Constants

Meter size	MS code Position 9	D_{flat} in %	Q_{flat} in kg/h	a in kg/h	b in %
Supreme 34	E7	0.2	150	0.38	-0.05
	D7	0.15	200	0.21	0.043
	C2, C3, C6	0.1	300	0.17	0.044
	70	0.75	150	0.25	0.583
	50	0.5	300	0.17	0.444
Supreme 36	E7	0.2	500	1.3	-0.05
	D7	0.15	667	0.71	0.043
	C2, C3, C5	0.1	1000	0.56	0.044
	70	0.75	500	0.83	0.583
	50	0.5	1000	0.56	0.444
Supreme 38	E7	0.2	1600	4	-0.05
	D7	0.15	2130	2.3	0.043
	C2, C3, C5	0.1	3200	1.8	0.044
	70	0.75	1600	2.7	0.583
	50	0.5	3200	1.8	0.444

Meter size	MS code Position 9	D_{flat} in %	Q_{flat} in kg/h	a in kg/h	b in %
Supreme 39	E7	0.2	5000	13	-0.05
	D7	0.15	6670	7.1	0.043
	C2, C3, C5	0.1	10000	5.6	0.044
	70	0.75	5000	8.3	0.583
	50	0.5	10000	5.6	0.444

4.3.1 Sample calculation for liquids

Accuracy using water at 20 °C as an example

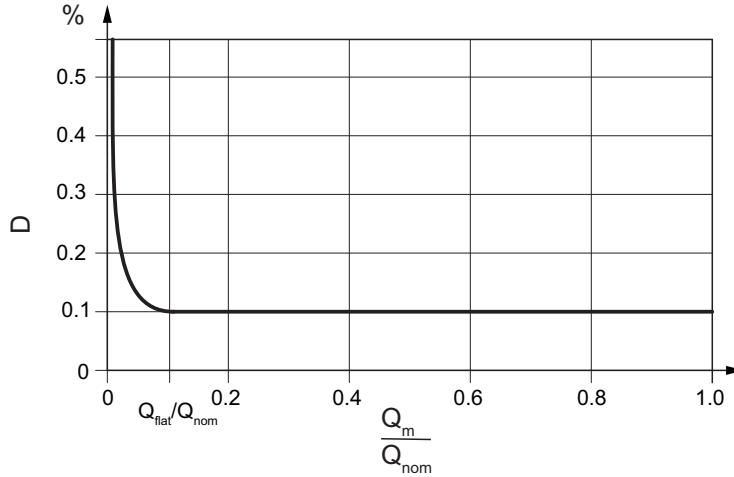

Fig. 10: Schematic dependency of the maximum deviation on the mass flow

D Maximum deviation in % Q_m Mass flow in kg/h
 Q_{nom} Nominal mass flow in kg/h Q_{flat} Mass flow above which D_{flat} applies, in kg/h

Turn down $Q_m:Q_{nom}$	Maximum deviation D	Water pressure loss
1:100	0.6 %	≈ 0 mbar (0 psi)
1:40	0.3 %	0.7 mbar (0.01 psi)
1:10	0.1 %	10 mbar (0.15 psi)
1:2	0.1 %	250 mbar (3.62 psi)
1:1	0.1 %	1000 mbar (14.50 psi)

Example

RC

U	S	36	H
1	2	3	4

 -

25	BA1	0
5	6	7

 -

0	C5	A
8	9	10

 -

NN00
11

 -

2
12

 -

JA	1
13	14

 /

15

Medium:	Liquid
Maximum deviation D_{flat} :	0.1 %
Q_{flat} :	1000 kg/h
Constant a :	0.56 kg/h
Constant b :	0.044 %
Value of mass flow Q_m :	500 kg/h

Calculation of the flow rate condition:

$$Q_m \geq Q_{\text{flat}}$$

Check whether $Q_m \geq Q_{\text{flat}}$:

$$Q_m = 500 \text{ kg/h} < Q_{\text{flat}} = 1000 \text{ kg/h}$$

As a result, the accuracy is calculated using the following formula:

$$D = \frac{a \times 100 \%}{Q_m} + b$$

Calculation of accuracy:

$$D = 0.56 \times 100 \% / 500 \text{ kg/h} + 0.044 \%$$

$$D = 0.156 \%$$

4.3.2 Sample calculation for gases

The maximum deviation in the case of gases depends on the product version selected, see also *Mass flow and density accuracy* [91].

Example

RC

U	S	36	H
1	2	3	4

 -

25	BA1	0
5	6	7

 -

0	50	A
8	9	10

 -

NN00
11

 -

2
12

 -

JA	1
13	14

 /

15

Medium:	Gas
Maximum deviation D_{flat} :	0.5 %
Q_{flat} :	1000 kg/h
Constant a :	0.56 kg/h
Constant b :	0.444 %
Value of mass flow Q_m :	200 kg/h

Calculation of the flow rate condition:

$$Q_m \geq Q_{\text{flat}}$$

Check whether $Q_m \geq Q_{\text{flat}}$:

$$Q_m = 200 \text{ kg/h} < Q_{\text{flat}} = 1000 \text{ kg/h}$$

As a result, the accuracy is calculated using the following formula:

$$D = \frac{a \times 100 \%}{Q_m} + b$$

Calculation of accuracy:

$$D = 0.56 \text{ kg/h} \times 100 \% / 200 \text{ kg/h} + 0.444 \%$$

$$D = 0.72 \%$$

4.4 Accuracy of density

4.4.1 For liquids

Meter size	Transmitter	Maximum deviation of density ¹⁾ in g/l (lb/ft ³)
Supreme 34	Essential	Down to 4 (0.25)
Supreme 36		
Supreme 38		
Supreme 39		
Supreme 34	Ultimate	Down to 0.5 (0.03)
Supreme 36		
Supreme 38		
Supreme 39		

¹⁾ Deviations possible depending on product version (meter size, type of calibration)

The maximum deviation depends on the product version selected, see also *Accuracy of mass flow and density according to the MS code* [▶ 21].

4.4.2 For gases

In most applications, density at standard conditions is fed into the transmitter and used to calculate the standard volume flow based on mass flow.

If gas pressure is a known value, after entering a reference density, the transmitter is able to calculate gas density from temperature and pressure as well (while assuming an ideal gas).

Alternatively, there is an option for measuring gas density. In order to do so, it is necessary to adapt the lower density limit value in the transmitter.

For most applications the direct measurement of the gas density will have insufficient accuracy.

4.5 Accuracy of mass flow and density according to the MS code

Accuracy for flow rate as well as density is selected via MS code position 9. Here a distinction is made between devices for measuring liquids and devices for measuring gases. No accuracy for density measurement is specified for gas measurement devices.

4.5.1 For liquids

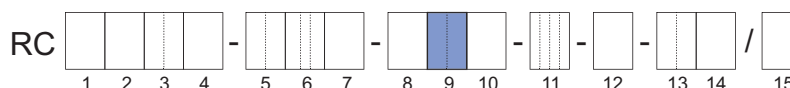

Essential

MS code Position 9	Maximum deviation of density ¹⁾ in g/l	Applicable measuring range of accuracy ²⁾ in kg/l	Maximum deviation D_{flat} for mass flow in %			
			Supreme 34	Supreme 36	Supreme 38	Supreme 39
E7	4	0.3 – 5	0.2	0.2	0.2	0.2
D7	4	0.3 – 5	0.15	0.15	0.15	0.15

¹⁾ Specified maximum deviation is achieved within the applicable measuring range for density.

²⁾ For Supreme 39, the density range deviates and is 0.3 - 2 kg/l.

Ultimate

MS code Position 9	Maximum deviation of density ¹⁾ in g/l	Applicable measuring range of accuracy ²⁾ in kg/l	Maximum deviation D_{flat} for mass flow in %			
			Supreme 34	Supreme 36	Supreme 38	Supreme 39
D7	4	0.3 – 5	0.15	0.15	0.15	0.15
C6	3	0.3 – 5	0.1	–	–	–
C5	2	0.3 – 5	–	0.1	0.1	0.1
C3	1	0.3 – 5	0.1	0.1	0.1	0.1
C2	0.5	0.3 – 2.5	0.1	0.1	0.1	0.1

¹⁾ Specified maximum deviation is achieved within the applicable measuring range for density.

²⁾ For Supreme 39, the density range deviates and is 0.3 - 2 kg/l.

4.5.2 For gases

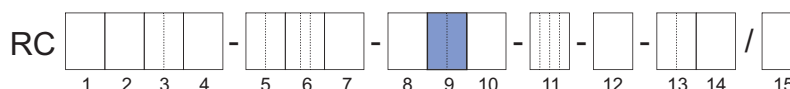

Essential

Maximum deviation D_{flat} of mass flow in %	MS code Position 9
0.75	70

Ultimate

Maximum deviation D_{flat} of mass flow in %	MS code Position 9
0.5	50

4.6 Volume flow accuracy

4.6.1 For liquids

The following formula can be used to calculate the accuracy of liquid volume flow:

$$D_V = \sqrt{D^2 + \left(\frac{\Delta\rho}{\rho} \times 100\%\right)^2}$$

D_V	Maximum deviation of volume flow in %	D	Maximum deviation of mass flow in %
$\Delta\rho$	Maximum deviation of density in kg/l	ρ	Density in kg/l

4.6.2 For gases

Accuracy of standard volume flow for gas with a fixed composition equals the maximum deviation D of the mass flow.

$$D_V = D$$



In order to determine the standard volume flow for gas, it is necessary to input a reference density in the transmitter. The accuracy specified is achieved only for fixed gas composites. Major deviations may appear if the gas composition changes.

4.7 Accuracy of temperature

Various medium temperature ranges are specified for Rotamass Supreme:

- *Standard:*
 - Integral type: -50 – 150 °C (-58 – 302 °F)
 - Remote type: -70 – 150 °C (-94 – 302 °F)
- *Mid-range:*
 - Remote type: -70 – 230 °C (-94 – 446 °F)
- *High:*
 - Remote type: 0 – 350 °C (32 – 662 °F)

Accuracy of temperature depends on the sensor temperature range selected (see *Medium temperature range* [▶ 28]) and can be calculated as follows:

Formula for temperature specifications *Standard* and *Mid-range*

$$\Delta T = 0.5 \text{ °C} + 0.005 \times |T_{pro} - 20 \text{ °C}|$$

ΔT	Maximum deviation of temperature
T_{pro}	Temperature of medium in °C

Formula for temperature specification *High*

$$\Delta T = 1.0 \text{ °C} + 0.008 \times |T_{pro} - 20 \text{ °C}|$$

ΔT	Maximum deviation of temperature
T_{pro}	Temperature of medium in °C

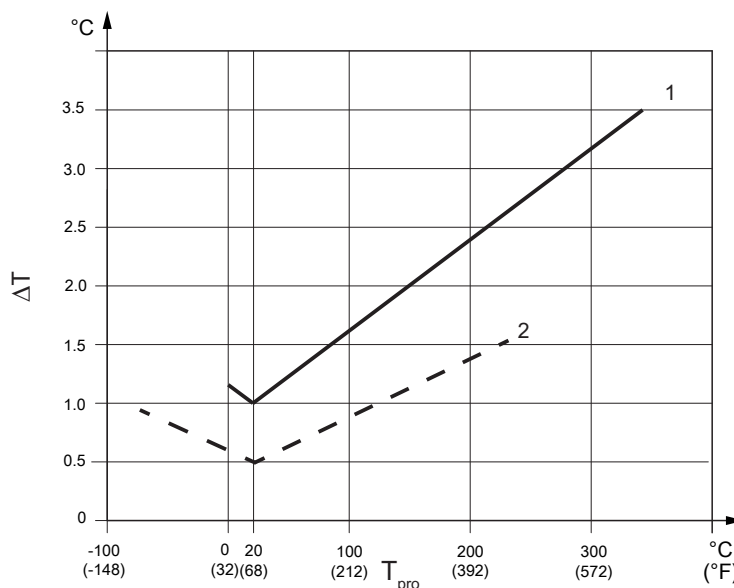

Fig. 11: Temperature accuracy

- 1 Temperature specification High
- 2 Temperature specifications Standard and Mid-range

Example

RC

U	S	36	H	-	40	BA1	0	-	2	C5	A	-	NN00	-	2	-	JA	1	/	
1	2	3	4		5	6	7		8	9	10		11		12		13	14		15

The sample MS code specifies the mid-temperature range.

Temperature of medium T_{pro}: 50 °C

Calculation of accuracy:

$$\Delta T = 0.5 \text{ °C} + 0.005 \times |50 \text{ °C} - 20 \text{ °C}|$$

$$\Delta T = 0.65 \text{ °C}$$

4.8 Repeatability

For liquids

When using default damping times, the specified repeatability of mass flow, density and temperature measurements equals half of the respective maximum deviation.

$$R = \frac{D}{2}$$

- R Repeatability
- D Maximum deviation

For gases

In deviation hereto, the following applies to mass and standard volume flow of gases:

$$R = \frac{D}{1.25}$$

4.9 Calibration conditions

4.9.1 Mass flow calibration and density adjustment

All Rotamass are calibrated in accordance with the state of the art at Rota Yokogawa. Optionally, the calibration can be performed according to a method accredited by DAkkS in accordance with DIN EN ISO/IEC 17025 (Option K5, see *Certificates* [▶ 101]).

Each Rotamass device comes with a standard calibration certificate.

Calibration takes place at reference conditions. Specific values are listed in the standard calibration certificate.

	Reference conditions
Medium	Water
Density	0.9 – 1.1 kg/l (56 – 69 lb/ft ³)
Medium temperature	10 – 35 °C (50 – 95 °F) Average temperature: 22.5 °C (72.5 °F)
Ambient temperature	10 – 35 °C (50 – 95 °F)
Process pressure (absolute)	1 – 2 bar (15 – 29 psi)

The accuracy specified is achieved at as-delivered calibration conditions stated.

4.9.2 Density calibration

Density calibration is performed for maximum deviation of 0.5 g/l (0.03 lb/ft³) (MS code position 9 _2).

Density calibration includes:

- Determination of calibration constants for medium densities at 0.7 kg/l (44 lb/ft³), 1 kg/l (62 lb/ft³) and 1.65 kg/l (103 lb/ft³) at 20 °C (68 °F) medium temperature
- Determination of temperature compensation coefficients at 20 – 80 °C (68 – 176 °F)
- Check of results for medium densities at 0.7 kg/l (44 lb/ft³), 1 kg/l (62 lb/ft³) and 1.65 kg/l (103 lb/ft³) at 20 °C (68 °F) medium temperature
- Special flow meter configuration:
 - Specific insulation of temperature sensors
 - Preaging for long-term stability
- Creation of density calibration certificate

4.10 Process pressure effect

Process pressure effect is defined as the change in sensor flow and density deviation due to process pressure change away from the calibration pressure. This effect can be corrected by dynamic pressure input or a fixed process pressure.

Tab. 1: Process pressure effect for Rotamass Supreme models wetted parts Stainless steel 1.4404/316L

Meter size	Deviation of Flow		Deviation of Density	
	% of rate per bar	% of rate per psi	g/l per bar	g/l per psi
Supreme 34	-0.0005	-0.00003	-0.066	-0.0046
Supreme 36	-0.0024	-0.00017	-0.193	-0.0133
Supreme 38	-0.0034	-0.00023	-0.378	-0.0261
Supreme 39	-0.0084	-0.00058	-0.377	-0.0260

Tab. 2: Process pressure effect for Rotamass Supreme models wetted parts Ni alloy C-22/ 2.4602

Meter size	Deviation of Flow		Deviation of Density	
	% of rate per bar	% of rate per psi	g/l per bar	g/l per psi
Supreme 34	-0.0005	-0.00003	-0.076	-0.0052
Supreme 36	-0.0023	-0.00016	-0.192	-0.0132
Supreme 38	-0.0035	-0.00024	-0.381	-0.0263
Supreme 39	-0.0074	-0.00051	-0.350	-0.0241

4.11 Process temperature effect

For mass flow and density measurement, process temperature effect is defined as the change in sensor flow and density accuracy due to process temperature change away from the calibration temperature. For temperature ranges, see *Medium temperature range* [p. 28].

Temperature effect on Zero

Temperature effect on Zero of mass flow can be corrected by zeroing at the process temperature.

Temperature effect on mass flow

The process temperature is measured and the temperature effect compensated. However due to uncertainties in the compensation coefficients and in the temperature measurement an uncertainty of this compensation is left. The typical rest error of Rotamass TI temperature effect on mass flow is:

Tab. 3: All models

Temperature range	Uncertainty of flow
Standard, Mid-range	±0.001 % of rate / °C (±0.00056 % of rate / °F)
High	±0.0011 % of rate / °C (±0.0006 % of rate / °F)

The temperature used for calculation of the uncertainty is the difference between process temperature and the temperature at calibration condition. For temperature ranges, see *Medium temperature range* [p. 28].

Temperature effect on density measurement (liquids)

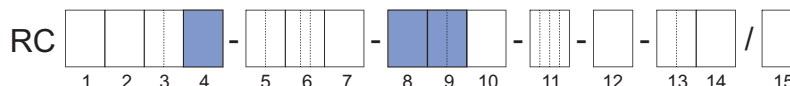

Process temperature influence:

Formula for metric values

$$D'_{\rho} = \pm k \times \text{abs}(T_{\text{pro}} - 20 \text{ }^{\circ}\text{C})$$

Formula for imperial values

$$D'_{\rho} = \pm k \times \text{abs}(T_{\text{pro}} - 68 \text{ }^{\circ}\text{F})$$

D'_{ρ} Additional density deviation due to the effect of medium temperature in kg/l (lb/ft³)

T_{pro} Temperature of medium in °C (°F)

k Constant for temperature effect on density measurement in g/l × 1/°C (lb/ft³ × 1/°F)

Tab. 4: Constants for particular meter size and MS code Position (see also *Medium temperature range* [28] and *Mass flow and density accuracy* [91])

Meter size	MS code Position 4	MS code Position 8	MS code Position 9	k in g/l × 1/°C (lb/ft ³ × 1/°F)
Supreme 34	S	0, 2	C3, C6, D7, E7	0.150 (0.0052)
		3		0.400 (0.0139)
		0	C2	0.060 (0.0021)
		3		0.210 (0.0073)
	H	0, 2	C3, C6, D7, E7	0.160 (0.0055)
		3		0.350 (0.0121)
		0	C2	0.022 (0.0008)
		3		0.110 (0.0038)
Supreme 36	S	0, 2	C3, C5, D7, E7	0.100 (0.0035)
		3		0.270 (0.0094)
		0	C2	0.029 (0.0010)
		3		0.125 (0.0043)
	H	0, 2	C3, C5, D7, E7	0.090 (0.0031)
		3		0.240 (0.0083)
		0	C2	0.015 (0.0005)
		3		0.075 (0.0026)
Supreme 38	S	0, 2	C3, C5, D7, E7	0.070 (0.0024)
		3		0.190 (0.0066)
		0	C2	0.024 (0.0008)
		3		0.100 (0.0035)
	H	0, 2	C3, C5, D7, E7	0.060 (0.0021)
		3		0.140 (0.0049)
		0	C2	0.015 (0.0005)
		3		0.065 (0.0023)
Supreme 39	S	0, 2	C3, C5, D7, E7	0.070 (0.0024)
		3		0.170 (0.0059)
		0	C2	0.024 (0.0008)
		3		0.090 (0.0031)
	H	0, 2	C3, C5, D7, E7	0.060 (0.0021)
		3		0.160 (0.0055)
		0	C2	0.011 (0.0004)
		3		0.055 (0.0019)

5 Operating conditions

5.1 Location and position of installation

Rotamass Coriolis flow meters can be mounted horizontally, vertically and at an incline. The measuring tubes should be completely filled with the medium during flow measurement as accumulations of air or formation of gas bubbles in the measuring tube may result in errors in measurement. Straight pipe runs at inlet or outlet are usually not required.

Avoid the following installation locations and positions:

- Measuring tubes as highest point in piping when measuring liquids
- Measuring tubes as lowest point in piping when measuring gases
- Immediately in front of a free pipe outlet in a downpipe
- Lateral positions

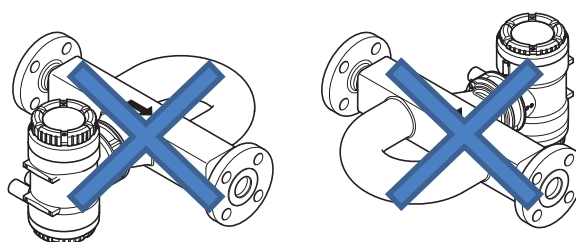
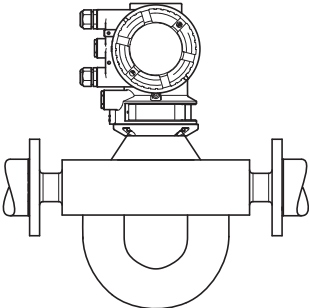
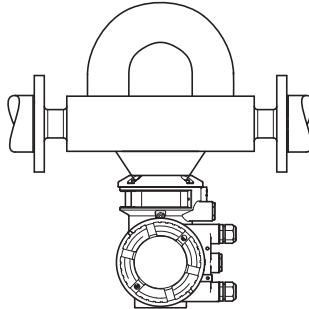
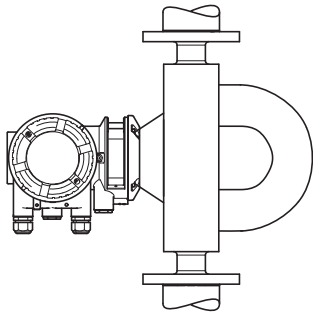

Fig. 12: Installation position to be avoided: Flow meter in sideways position

5.1.1 Sensor installation position

Sensor installation position as a function of the medium

Installation position	Medium	Description
Horizontal, measuring tubes at bottom 	Liquid	The measuring tubes are oriented toward the bottom. Accumulation of gas bubbles is avoided.
Horizontal, measuring tubes at top 	Gas	The measuring tubes are oriented toward the top. Accumulation of liquid, such as condensate is avoided.

Installation position	Medium	Description
Vertical, direction of flow towards the top 	Liquid/gas	The sensor is installed on a pipe with the direction of flow towards the top. Accumulation of gas bubbles or solids is avoided. This position allows for complete self-draining of the measuring tubes.

5.2 Installation instructions

The following instructions for installation must be observed:

1. Protect the flow meter from direct sun irradiation in order to avoid exceeding the maximum allowed internal temperature of the transmitter.
2. In case of installing two sensors of the same kind back-to-back redundantly, use a customized design and contact the responsible Yokogawa sales organization.
3. Avoid installation locations susceptible to cavitation, such as immediately behind a control valve.
4. In case that the medium temperatures deviate approx. 80 °C from the ambient temperature, insulating the sensor is recommended in order to avoid injuries as well as to maintain utmost accuracy, see *Insulation and heat tracing* [▶ 32].
5. Avoid installation directly behind rotary and gear pumps to prevent fluctuations in pressure from interfering with the resonance frequency of the Rotamass measuring tubes.
6. In case of remote installation: When installing the connection cable between sensor and transmitter, keep the cable temperature above -10 °C (14 °F) to prevent cable damage from the installation stresses.

5.3 Process conditions



The pressure and temperature ratings presented in this section represent the design values for the devices. For individual applications (e.g. marine applications with option MC_) further limitations may apply according to the respective applicable regulations. For details see chapter *Marine Approval* [▶ 105]

5.3.1 Medium temperature range



The Rotamass specification for use in Ex areas is different, see Ex instruction manual (IM 01U10X_--00EN).

For Rotamass Supreme the following medium temperature ranges are available:

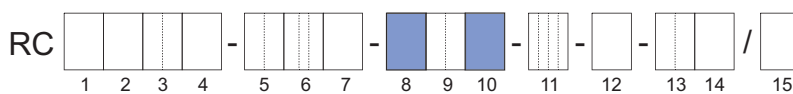

Temperature range	MS code Position 8	Medium temperature in °C (°F)	Design	MS code Position 10
Standard	0	-50 – 150 (-58 – 302)	Integral type	0, 2
		-70 – 150 (-94 – 302)	Remote type	A, B, E, F, J, K
Mid-range	2	-70 – 230 (-94 – 446)		B, F, K
High	3	0 – 350 (32 – 662)		B, F, K

5.3.2 Density

Meter size	Measuring range of density
Supreme 34	0 – 5 kg/l (0 – 310 lb/ft³)
Supreme 36	
Supreme 38	
Supreme 39	0 – 2 kg/l (0 – 120 lb/ft³)

Rather than being measured directly, density of gas is usually calculated using its reference density, process temperature and process pressure.

5.3.3 Pressure

The maximum allowed process pressure depends on the process connection temperature and the process connections selected.

The following diagrams show the process pressure as a function of process connection temperature as well as the process connection used (type and size of process connection).

ASME class 150
JPI class 150

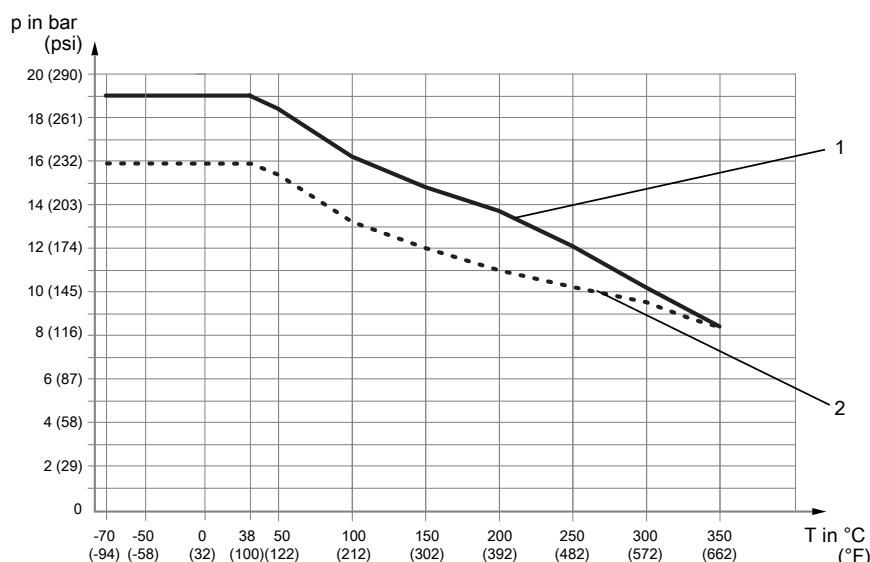

Fig. 13: Allowed process pressure as a function of process connection temperature

- 1 Flange suitable for ASME B16.5 class 150
- 2 Flange suitable for JPI class 150

ASME class 300
EN PN40
JPI class 300

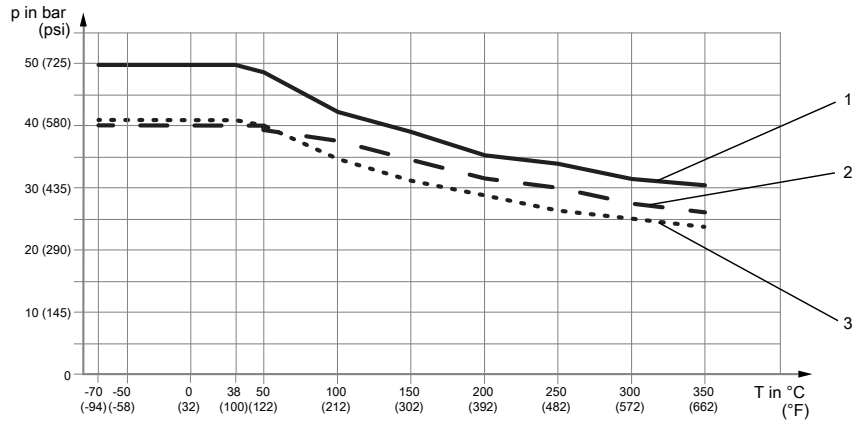

Fig. 14: Allowed process pressure as a function of process connection temperature

- 1 Process connection suitable for ASME B16.5 class 300
- 2 Process connection suitable for EN 1092-1 PN40
- 3 Process connection suitable for JPI class 300

ASME class 600
EN PN63
JPI class 600

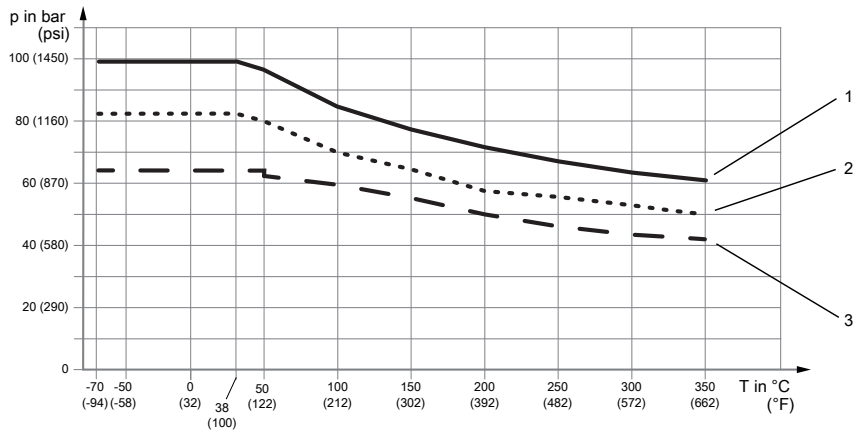

Fig. 15: Allowed process pressure as a function of process connection temperature

- 1 Flange suitable for ASME B16.5 class 600
- 2 Flange suitable for JPI class 600
- 3 Flange suitable for EN 1092-1 PN63

EN PN100

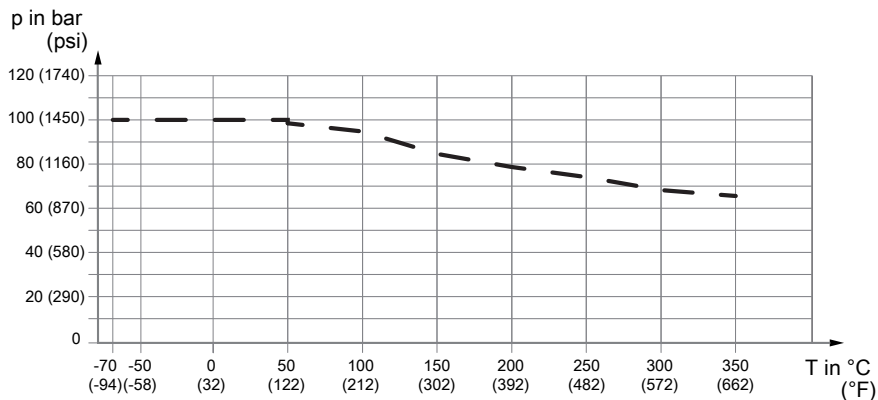

Fig. 16: Allowed process pressure as a function of process connection temperature, suitable for flange EN 1092-1 PN100

JIS 10K
JIS 20K

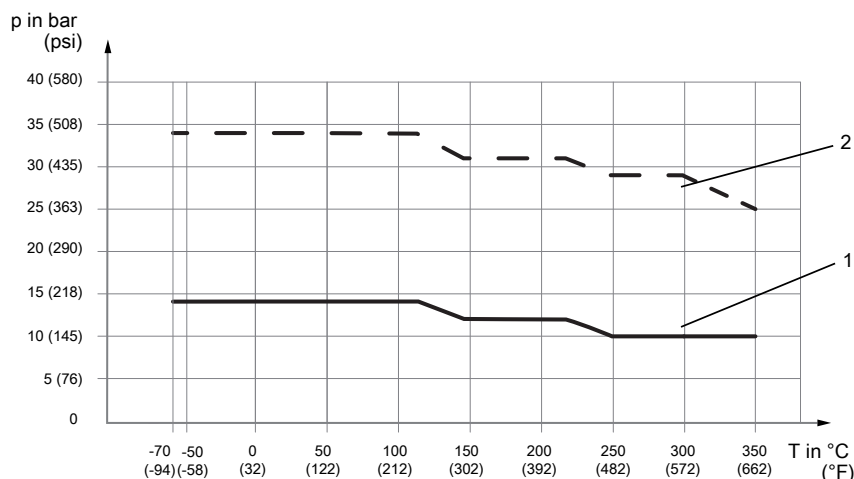

Fig. 17: Allowed process pressure as a function of process connection temperature

- 1 Flange suitable for JIS B 2220 10K
- 2 Flange suitable for JIS B 2220 20K

Process connections with internal thread

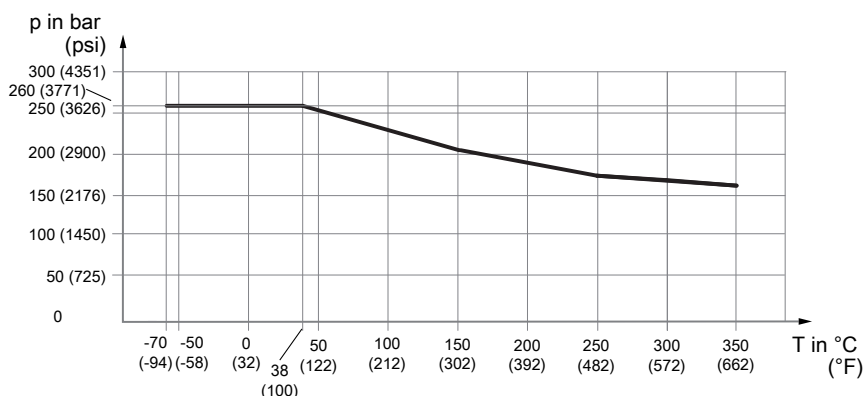

Fig. 18: Allowed process pressure as a function of temperature, suitable for process connection temperature, suitable for process connections with internal thread G and NPT

Rupture disc

The rupture disc is located on the sensor housing. It is available as an option, see *rupture disc* [▶ 103]. The rupture disc's bursting pressure is 20 bar. In the case of big nominal diameters and high pressures, it is not possible to ensure that the entire process pressure is released across the rupture disc. In the event this is necessary, it is possible to request a customized design from the responsible Yokogawa sales organization. In the event of a burst pipe, the rupture disc provides an acoustic signal in applications with gases.

5.3.4 Mass flow

For **liquids**, in general, 20 % - 50 % of maximum mass flow Q_{max} is a reasonable measuring range, see *Mass flow* [▶ 14].

For **gases**, as a result of low gas density, the maximum mass flow Q_{max} is usually not reached in gas measurements. In general, the maximum flow velocity should not exceed 33 % of the sonic velocity of the medium.

5.3.5 Effect of temperature on accuracy

Effect of medium temperature

The specified accuracy of the density measurement (see *Mass flow and density accuracy* [▶ 91]) applies at calibration conditions and may deteriorate if medium temperatures deviate from those conditions. The effect of temperature is minimal for the product version with MS code position 9, value C2.

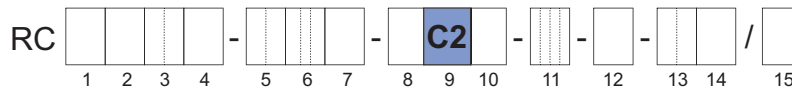

The effect of temperature is calculated as follows:

Formula for metric values

$$D'_{\rho} = \pm k \times \text{abs}(T_{\text{pro}} - 20\text{ }^{\circ}\text{C})$$

Formula for imperial values

$$D'_{\rho} = \pm k \times \text{abs}(T_{\text{pro}} - 68\text{ }^{\circ}\text{F})$$

- D'_{ρ} Additional density deviation due to the effect of medium temperature in kg/l (lb/ft³)
- T_{pro} Temperature of medium in °C (°F)
- k Constant for temperature effect on density measurement in g/l × 1/°C (lb/ft³ × 1/°F)

5.3.6 Insulation and heat tracing



In case that the medium temperature deviates more than 80 °C (176 °F) from the ambient temperature, insulating the sensor is recommended to avoid negative effects from temperature fluctuations on accuracy.

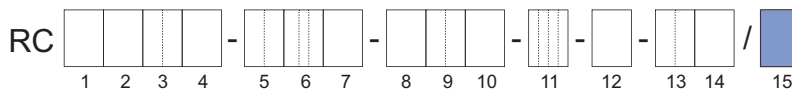

Overview of device options for insulation and heat tracing for remote type

Description	Options
▪ Insulation	T10
▪ Insulation ▪ Heat tracing without ventilation	T21, T22, T26
▪ Insulation ▪ Heat tracing with ventilation	T31, T32, T36

For details about the device options see chapter under the same heading *Insulation and heat tracing* [▶ 100] in the MS code description.

If the sensor is insulated subsequently, the following must be noted:

- Do not insulate transmitter as well.
- In case of remote type, do not insulate the terminal box of the sensor.
- Do not expose transmitters to ambient temperatures exceeding 60 °C (140 °F).
- The preferred insulation is 80 mm (3.15 inch) thick with a heat transfer coefficient of 0.4 W/m² K (0,07 Btu/ ft² °F).

Electrical heating can be provided subsequently. Electromagnetic insulation is required in case the heating device is controlled by phase-fired control or pulse train.



In hazardous areas, subsequent application of insulation, heating jacket or heating strips is not permitted.

5.3.7 Secondary containment

Some applications or environment conditions require secondary containment retaining the process pressure for increased safety. All Rotamass TI have a secondary containment filled with inert gas. The typical rupture pressure values of the secondary housing are defined in the below table.

Typical Rupture pressure

Supreme 34	Supreme 36	Supreme 38	Supreme 39
Rupture pressure in bar (psi)	Rupture pressure in bar (psi)	Rupture pressure in bar (psi)	Rupture pressure in bar (psi)
120 (1740)	120 (1740)	120 (1740)	80 (1160)

5.4 Ambient conditions

Rotamass can be used at demanding ambient conditions.

In doing so, the following specifications must be taken into account:

Ambient temperature	<ul style="list-style-type: none"> ▪ Sensor: see [▶ 34] ▪ Transmitter: -40 – 60 °C (-40 – 140 °F) ▪ Cable: <ul style="list-style-type: none"> standard (option L_{...}): -50 °C – 80 °C (-58 °F – 176 °F) fire retardant (option Y_{...}): -35 °C – 80 °C (-31 °F – 176 °F) ▪ Transmitter display has limited legibility below -20 °C (-4 °F)
Storage temperature	<ul style="list-style-type: none"> ▪ Sensor: -50 – 80 °C (-58 – 176 °F) ▪ Transmitter: -40 – 60 °C (-40 – 140 °F) ▪ Cable: <ul style="list-style-type: none"> standard (option L_{...}): -50 °C – 80 °C (-58 °F – 176 °F) fire retardant (option Y_{...}): -35 °C – 80 °C (-31 °F – 176 °F)
Relative humidity	0 – 95 %
IP code	IP66/67 for transmitters and sensors when using the appropriate cable glands
Allowable pollution degree in surrounding area according to EN 61010-1	4 (in operation)
Resistance to vibration according to IEC 60068-2-6 (without option T _{...})	Transmitter: 10 – 500 Hz, 1g Sensor: 25 – 100 Hz, 4g
Electromagnetic compatibility (EMC) according to IEC/EN 61326-1, Class A, Table 2, IEC/EN 61326-2-3, IEC/EN 61000-3-2, IEC/EN 61000-3-3 as well as NAMUR recommendation NE 21 and environmental tests according to DNVGL-CG-0339	Requirement during immunity tests: The output signal fluctuation is specified within ±1 % of the output span.
Maximum altitude	2000 m (6600 ft) above mean sea level (MSL)
Overvoltage category according to IEC/EN 61010-1	II

5.4.1 Allowed ambient temperature for sensor

The allowed ambient temperature depends on the following product properties:

- Temperature specification, see *Medium temperature range* [▶ 28]
- Housing design
 - Integral type
 - Remote type
- Medium temperature
- Connecting cable type (Options L₋₋₋ and Y₋₋₋)

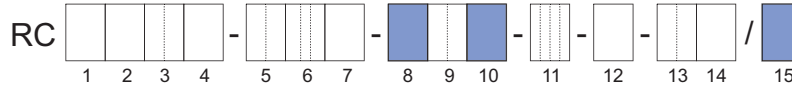

The allowed combinations of medium and ambient temperature for the sensor are illustrated as gray areas in the diagrams below.



The Rotamass specification for use in Ex areas is different, see Ex instruction manual (IM 01U10X₋₋₋-00EN).



The minimum allowed ambient temperature for remote fire retardant connecting cable type Y₋₋₋ is -35 °C. In case of process temperatures below -35 °C, the minimum allowed ambient temperature has to be reconsidered.

Temperature specification Standard, integral type

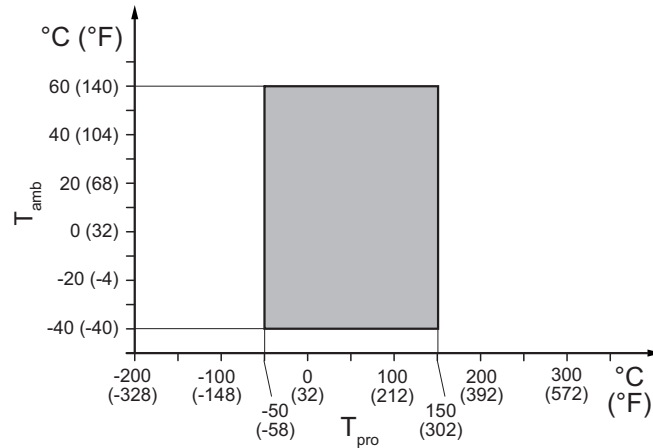

Fig. 19: Allowed medium and ambient temperatures, integral type

T_{amb} Ambient temperature
 T_{pro} Medium temperature

Temperature specification Standard, remote type

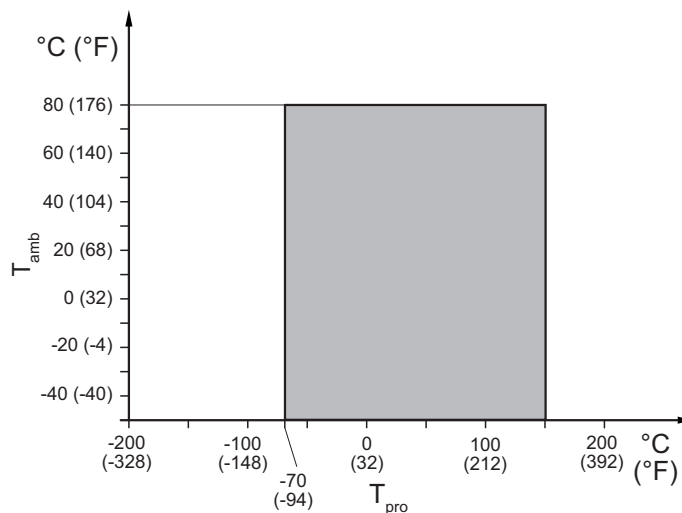

Fig. 20: Allowed medium and ambient temperatures, remote type

Temperature specification Mid-range

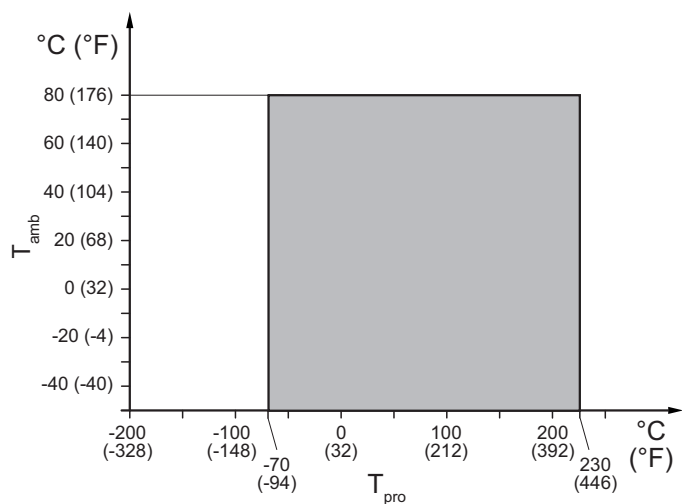

Fig. 21: Allowed medium and ambient temperatures

Temperature specification High

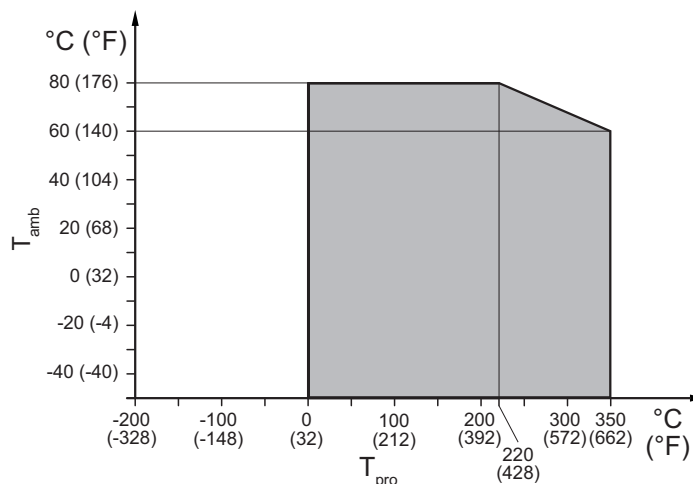

Fig. 22: Allowed medium and ambient temperatures

5.4.2 Temperature specification in hazardous areas

Maximum ambient and process temperatures depending on explosion groups and temperature classes can be determined via the MS code or via the MS code together with the Ex code (see the corresponding Ex instruction manual).

MS code:
 Pos. 2: S
 Pos. 8: 0
 Pos. 10: 0, 2
 Pos. 11: _F21, FF11
 Ex code:
 6.85.86.87.54.10

The following figure shows the relevant positions of the MS code:

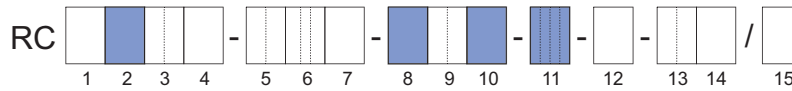

Tab. 5: Temperature classification

Temperature class	Maximum ambient temperature in °C (°F)	Maximum medium temperature in °C (°F)
T6	43 (109)	66 (150)
T5	58 (136)	82 (179)
T4	60 (140)	118 (244)
T3	60 (140)	150 (302)
T2	60 (140)	150 (302)
T1	60 (140)	150 (302)

MS code:
 Pos. 2: S
 Pos. 8: 0
 Pos. 10: 0, 2
 Pos. 11: _F22, FF12
 Ex code:
 2.78.79.81.54.10

The following figure shows the relevant positions of the MS code:

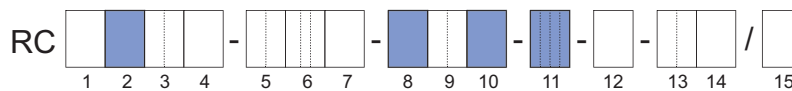

Tab. 6: Temperature classification

Temperature class	Maximum ambient temperature in °C (°F)	Maximum medium temperature in °C (°F)
T6	59 (138)	59 (138)
T5	60 (140)	75 (167)
T4	60 (140)	112 (233)
T3	60 (140)	150 (302)
T2	60 (140)	150 (302)
T1	60 (140)	150 (302)

MS code:
 Pos. 2: S
 Pos. 8: 0
 Pos. 10: A, E, J
 Pos. 11: _F21, FF11
 Ex code:
 6.85.86.87.54.10

The following figure shows the relevant positions of the MS code:

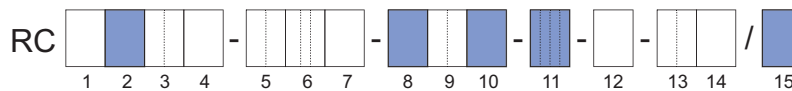

Tab. 7: Temperature classification

Temperature class	Maximum ambient temperature in °C (°F)		Maximum medium temperature in °C (°F)
	Option L_ _ _	Option Y_ _ _ ¹⁾	
T6	41 (105)	41 (105)	66 (150)
T5	56 (132)	56 (132)	82 (179)
T4	80 (176)	62 (143)	118 (244)
T3	78 (172)	49 (120)	150 (302)
T2	78 (172)	49 (120)	150 (302)
T1	78 (172)	49 (120)	150 (302)

¹⁾ not with MS code Pos. 11: FF11

MS code:
Pos. 2: S
Pos. 8: 0
Pos. 10: A, E, J
Pos. 11: _F22, FF12
Ex code:
2.78.79.81.54.10

The following figure shows the relevant positions of the MS code:

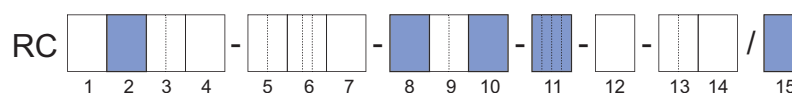

Tab. 8: Temperature classification

Temperature class	Maximum ambient temperature in °C (°F)		Maximum medium temperature in °C (°F)
	Option L_ _ _ _	Option Y_ _ _ _ ¹⁾	
T6	59 (138)	59 (138)	59 (138)
T5	75 (167)	75 (167)	75 (167)
T4	80 (176)	65 (149)	112 (233)
T3	78 (172)	49 (120)	150 (302)
T2	78 (172)	49 (120)	150 (302)
T1	78 (172)	49 (120)	150 (302)

¹⁾ not with MS code Pos. 11: FF12

MS code:
Pos. 2: S
Pos. 8: 0
Pos. 10: B, F, K
Pos. 11: _F21, FF11
Ex code:
6.85.86.87.54.10

The following figure shows the relevant positions of the MS code:

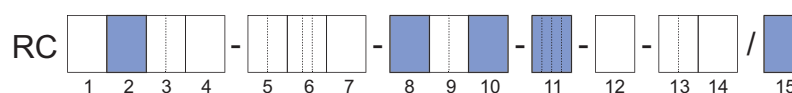

Tab. 9: Temperature classification

Temperature class	Maximum ambient temperature in °C (°F)		Maximum medium temperature in °C (°F)
	Option L_ _ _ _	Option Y_ _ _ _ ¹⁾	
T6	47 (116)	47 (116)	66 (150)
T5	62 (143)	62 (143)	82 (179)
T4	80 (176)	74 (165)	118 (244)
T3	80 (176)	70 (158)	150 (302)
T2	80 (176)	70 (158)	150 (302)
T1	80 (176)	70 (158)	150 (302)

¹⁾ not with MS code Pos. 11: FF11

MS code:
Pos. 2: S
Pos. 8: 0
Pos. 10: B, F, K
Pos. 11: _F22, FF12
Ex code:
2.78.79.81.54.10

The following figure shows the relevant positions of the MS code:

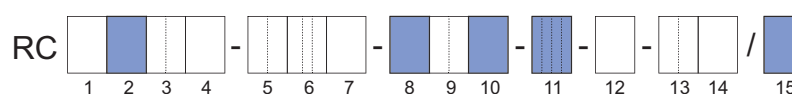

Tab. 10: Temperature classification

Temperature class	Maximum ambient temperature in °C (°F)		Maximum medium temperature in °C (°F)
	Option L_ _ _ _	Option Y_ _ _ _ ¹⁾	
T6	59 (138)	59 (138)	59 (138)
T5	75 (167)	75 (167)	75 (167)
T4	80 (176)	74 (165)	112 (233)
T3	80 (176)	70 (158)	150 (302)
T2	80 (176)	70 (158)	150 (302)
T1	80 (176)	70 (158)	150 (302)

¹⁾ not with MS code Pos. 11: FF12

MS code:
 Pos. 2: S
 Pos. 8: 2
 Pos. 10: B, F, K
 Pos. 11: _F21, FF11
 Ex code:
 6.85.86.87.89.80

The following figure shows the relevant positions of the MS code:

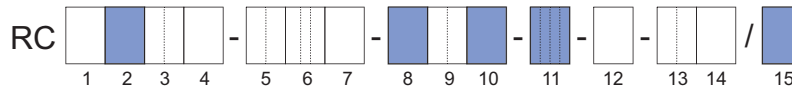

Tab. 11: Temperature classification

Temperature class	Maximum ambient temperature in °C (°F)		Maximum medium temperature in °C (°F)
	Option L_ _ _ _	Option Y_ _ _ _ ¹⁾	
T6	47 (116)	47 (116)	66 (150)
T5	62 (143)	62 (143)	82 (179)
T4	80 (176)	74 (165)	118 (244)
T3	80 (176)	64 (147)	185 (365)
T2	80 (176)	59 (138)	220 (428)
T1	80 (176)	59 (138)	220 (428)

¹⁾ not with MS code Pos. 11: FF11

MS code:
 Pos. 2: S
 Pos. 8: 2
 Pos. 10: B, F, K
 Pos. 11: _F22, FF12
 Ex code:
 2.78.79.81.85.80

The following figure shows the relevant positions of the MS code:

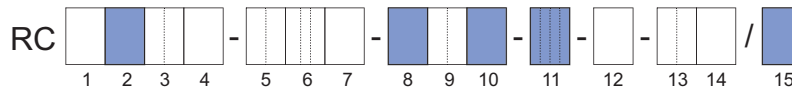

Tab. 12: Temperature classification

Temperature class	Maximum ambient temperature in °C (°F)		Maximum medium temperature in °C (°F)
	Option L_ _ _ _	Option Y_ _ _ _ ¹⁾	
T6	59 (138)	59 (138)	59 (138)
T5	75 (167)	75 (167)	75 (167)
T4	80 (176)	74 (165)	112 (233)
T3	80 (176)	64 (147)	181 (357)
T2	80 (176)	59 (138)	220 (428)
T1	80 (176)	59 (138)	220 (428)

¹⁾ not with MS code Pos. 11: FF12

MS code:
 Pos. 2: S
 Pos. 8: 3
 Pos. 10: B, F, K
 Pos. 11: _F21, _F22, FF11, FF12
 Ex code:

The following figure shows the relevant positions of the MS code:

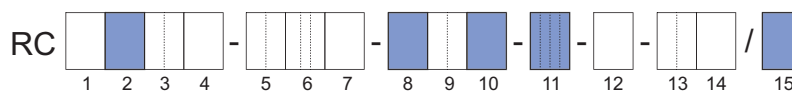

Tab. 13: Temperature classification

Temperature class	Maximum ambient temperature in °C (°F)		Maximum medium temperature in °C (°F)
	Option L_ _ _ _	Option Y_ _ _ _ ¹⁾	
T6	62 (143)	62 (143)	65 (149)
T5	77 (170)	77 (170)	80 (176)
T4	80 (176)	74 (165)	115 (239)
T3	80 (176)	65 (149)	180 (356)
T2	73 (163)	50 (122)	275 (527)
T1	60 (140)	40 (104)	350 (662)

¹⁾ not with MS code Pos. 11: FF11 and FF12

6 Mechanical specification

6.1 Design

The Rotamass flow meter is available with two versions:

- Integral type, sensor and transmitter are firmly connected
- Remote type
 - Standard terminal box
 - Long neck

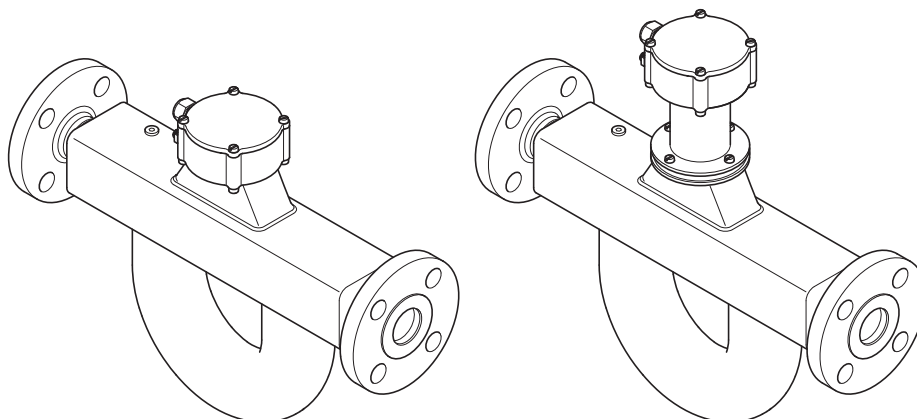
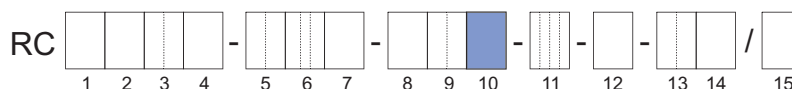

Fig. 23: Standard terminal box and long neck



Design	Design	Available temperature specifications	MS code Position 10
Integral type	Direct connection	Standard	0, 2
Remote type	Standard terminal box	Standard	A, E, J
	Long neck	Standard Mid-range High	B, F, K



If insulation (e.g. device option / T_ _) is planned, it is mandatory to use the remote type with long neck.



The design influences the temperature specification for Ex-approved Rotamass, see Ex instruction manual (IM 01U10X_ _-00EN-R).

6.2 Material

6.2.1 Material wetted parts

The wetted parts of Rotamass Supreme are available in two material versions.

For corrosive media, use of a corrosion-resistant nickel alloy (nickel alloy C-22/2.4602) is recommended for wetted parts.

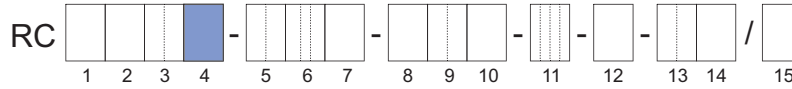

Material	MS code Position 4
Stainless steel 1.4404/316L	S
Nickel alloy C-22/2.4602	H

6.2.2 Non-wetted parts

Housing material of sensor and transmitter are specified via MS code position 7 and position 10.

Sensor housing material

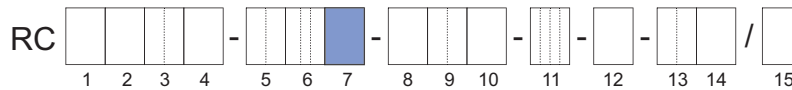

Housing material	MS code Position 7
Stainless steel 1.4301/304, 1.4404/316L	0
Stainless steel 1.4404/316L	1

Transmitter housing material, coating and bracket

The transmitter housing is available with different coatings:

- Standard coating
Urethane-cured polyester powder coating
- Corrosion protection coating
Three-layer coating with high mechanical and chemical resistance (polyurethane coating on two layers of epoxy coating)

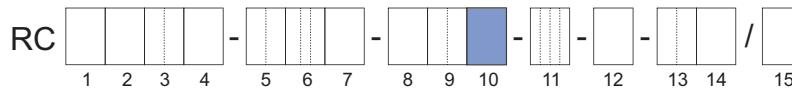

Housing material	Coating	Design	MS code Position 10	Bracket material
Aluminum Al-Si10Mg(Fe)	Standard coating	Integral type	0	–
		Remote type	A, B	Stainless steel 1.4301/304
	Corrosion protection coating	Integral type	2	–
		Remote type	E, F	Stainless steel 1.4301/304
Stainless steel CF8M	–	Remote type	J, K	Stainless steel 1.4404/316L
	–			

See also *Design and housing* [▶ 92].

Nameplate

For stainless steel transmitter the nameplates are made of stainless steel 1.4404/316L. In case of sensor housing material stainless steel 1.4404/316L (MS code position 7, value 1), nameplates of sensor are made of stainless steel 1.4404/316L.

6.3 Process connections, dimensions and weights of sensor

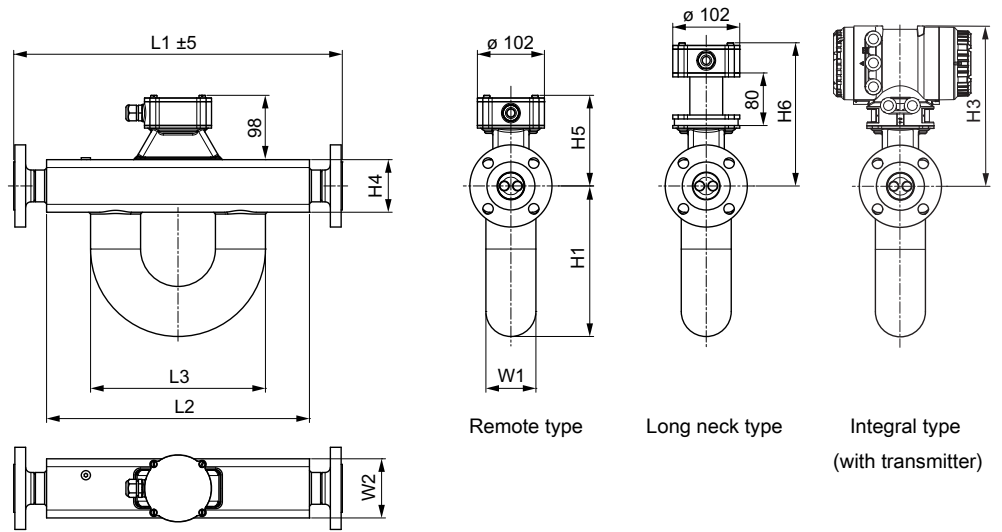

Fig. 24: Dimensions in mm

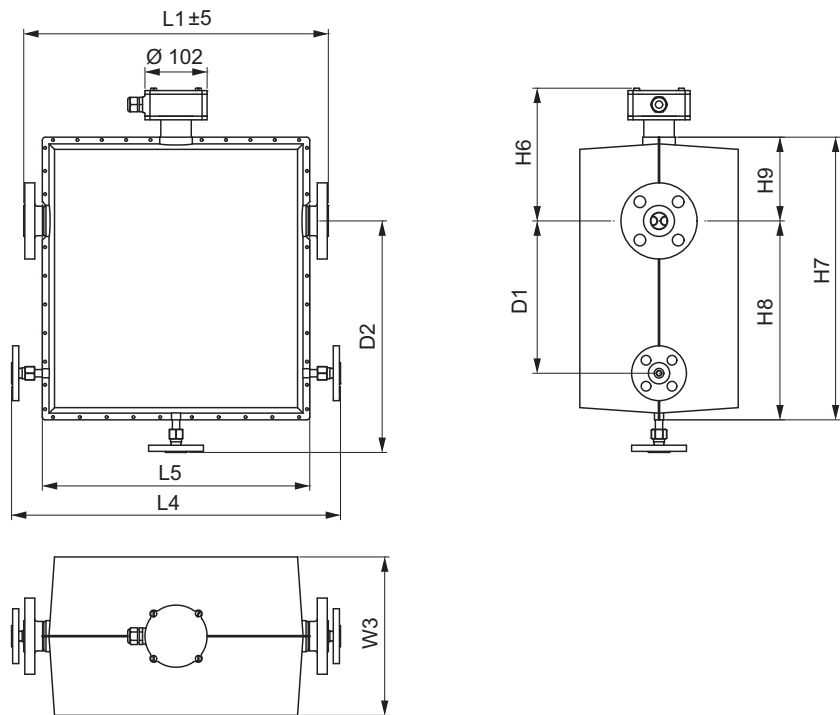

Fig. 25: Dimensions in mm: version with insulation housing

Tab. 14: Dimensions without length L1

Meter size	L2	L3	L4	L5	W1	W2	W3	D1	D2
	in mm (inch)								
Supreme 34	272 (10.7)	212 (8.3)	420 (16.5)	310 (12.2)	60 (2.4)	80 (3.1)	240 (9.4)	200 (7.9)	330 (13)
Supreme 36	400 (15.7)	266 (10.5)	540 (21.3)	439 (17.3)	76 (3)	90 (3.5)	260 (10.2)	250 (9.8)	380 (15)
Supreme 38	490 (19.3)	267 (10.5)	640 (25.2)	530 (20.9)	89 (3.5)	110 (4.3)	260 (10.2)	250 (9.8)	430 (16.9)
Supreme 39	850 (33.5)	379 (14.9)	1000 (39.4)	894 (35.2)	129 (5.1)	160 (6.3)	302 (11.9)	350 (13.8)	545 (21.5)

Tab. 15: Dimensions without length L1

Meter size	H1	H3	H4	H5	H6	H7	H8	H9
	in mm (inch)							
Supreme 34	177 (7)	279 (11)	80 (3.1)	138 (5.4)	218 (8.6)	411 (16.2)	273 (10.7)	138 (5.4)
Supreme 36	230 (9.1)	279 (11)	80 (3.1)	138 (5.4)	218 (8.6)	464 (18.3)	326 (12.8)	138 (5.4)
Supreme 38	268 (10.6)	289 (11.4)	100 (3.9)	148 (5.8)	228 (9)	524 (20.6)	376 (14.8)	148 (5.8)
Supreme 39	370 (14.6)	306 (12)	135 (5.3)	165 (6.5)	246 (9.7)	668 (26.3)	503 (19.8)	165 (6.5)

Overall length L1 and weight

The overall length of the sensor depends on the selected process connection (type and size of flange). The following tables list the overall length and weight (without insulation or heating) as functions of the individual process connection.

The weights in the tables are for the remote type with standard neck. Additional weight for the remote type with long neck: 1 kg (2.2 lb). Additional weight for the integral type: 3.5 kg (7.7 lb).

Process connections suitable for ASME B16.5

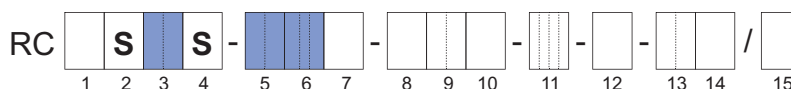

Tab. 16: Overall length L1 and weight of sensor (process connections: ASME, wetted parts: stainless steel)

Process connections	MS code pos.		Supreme 34		Supreme 36		Supreme 38		Supreme 39	
	5	6	L1 in mm (inch)	Weight in kg (lb)	L1 in mm (inch)	Weight in kg (lb)	L1 in mm (inch)	Weight in kg (lb)	L1 in mm (inch)	Weight in kg (lb)
ASME 1/2" class 150	15	BA1	370 (14.6)	10 (22)	-	-	-	-	-	-
ASME 1/2" class 300		BA2	370 (14.6)	10.4 (23)	-	-	-	-	-	-
ASME 1/2" class 600		BA4	380 (15)	10.6 (23)	-	-	-	-	-	-
ASME 1/2" class 600, ring joint		CA4	380 (15)	10.6 (23)	-	-	-	-	-	-

Process connections	MS code pos.		Supreme 34		Supreme 36		Supreme 38		Supreme 39	
	5	6	L1 in mm (inch)	Weight in kg (lb)	L1 in mm (inch)	Weight in kg (lb)	L1 in mm (inch)	Weight in kg (lb)	L1 in mm (inch)	Weight in kg (lb)
ASME 1" class 150	25	BA1	370 (14.6)	11 (24)	500 (19.7)	14.8 (33)	–	–	–	–
ASME 1" class 300		BA2	370 (14.6)	11.8 (26)	500 (19.7)	15.8 (35)	–	–	–	–
ASME 1" class 600		BA4	390 (15.4)	12.2 (27)	520 (20.5)	16.2 (36)	–	–	–	–
ASME 1" class 600, ring joint		CA4	390 (15.4)	12.4 (27)	520 (20.5)	16.2 (36)	–	–	–	–
ASME 1½" class 150	40	BA1	380 (15)	11.8 (26)	500 (19.7)	15.8 (35)	600 (23.6)	25 (55)	–	–
ASME 1½" class 300		BA2	380 (15)	14.2 (31)	510 (20.1)	18.2 (40)	600 (23.6)	27 (60)	–	–
ASME 1½" class 600		BA4	400 (15.7)	15.2 (34)	530 (20.9)	19.2 (42)	620 (24.4)	28.2 (62)	–	–
ASME 1½" class 600, ring joint		CA4	400 (15.7)	15.4 (34)	530 (20.9)	19.4 (43)	620 (24.4)	28.2 (62)	–	–
ASME 2" class 150	50	BA1	–	–	510 (20.1)	17.4 (38)	600 (23.6)	26.4 (58)	–	–
ASME 2" class 300		BA2	–	–	510 (20.1)	19 (42)	600 (23.6)	28 (62)	–	–
ASME 2" class 600		BA4	–	–	540 (21.3)	20.8 (46)	630 (24.8)	29.6 (65)	–	–
ASME 2" class 600, ring joint		CA4	–	–	540 (21.3)	20.8 (46)	630 (46)	29.8 (46)	–	–
ASME 2½" class 150	65	BA1	–	–	–	–	610 (24)	29.6 (65)	–	–
ASME 2½" class 300		BA2	–	–	–	–	610 (24)	31 (68)	–	–
ASME 2½" class 600		BA4	–	–	–	–	640 (25.2)	33.2 (73)	–	–
ASME 2½" class 600, ring joint		CA4	–	–	–	–	640 (25.2)	33.4 (74)	–	–
ASME 3" class 150	80	BA1	–	–	–	–	610 (24)	30.6 (67)	1000 (39.4)	60.2 (133)
ASME 3" class 300		BA2	–	–	–	–	620 (24.4)	34.2 (75)	1000 (39.4)	63.4 (140)
ASME 3" class 600		BA4	–	–	–	–	640 (25.2)	37.2 (82)	1000 (39.4)	65.4 (144)
ASME 3" class 600, ring joint		CA4	–	–	–	–	640 (25.2)	37.6 (83)	1000 (39.4)	65.8 (145)
ASME 4" class 150	1H	BA1	–	–	–	–	–	–	1000 (39.4)	63.8 (141)
ASME 4" class 300		BA2	–	–	–	–	–	–	1000 (39.4)	71.4 (157)
ASME 4" class 600		BA4	–	–	–	–	–	–	1030 (40.6)	82 (181)
ASME 4" class 600, ring joint		CA4	–	–	–	–	–	–	1030 (40.6)	82.4 (182)

Process connections	MS code pos.		Supreme 34		Supreme 36		Supreme 38		Supreme 39	
	5	6	L1 in mm (inch)	Weight in kg (lb)	L1 in mm (inch)	Weight in kg (lb)	L1 in mm (inch)	Weight in kg (lb)	L1 in mm (inch)	Weight in kg (lb)
ASME 5" class 150	1Q	BA1	–	–	–	–	–	–	1000 (39.4)	65.2 (144)
ASME 5" class 300		BA2	–	–	–	–	–	–	1000 (39.4)	77.2 (170)
ASME 5" class 600		BA4	–	–	–	–	–	–	1040 (40.9)	102.8 (227)
ASME 5" class 600, ring joint		CA4	–	–	–	–	–	–	1040 (40.9)	103.6 (228)

Meaning of "–": not available

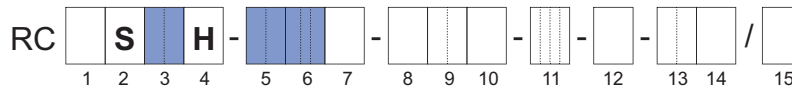

Tab. 17: Overall length L1 and weight of sensor (process connections: ASME, wetted parts: Ni alloy C-22/2.4602)

Process connections	MS code pos.		Supreme 34		Supreme 36		Supreme 38		Supreme 39	
	5	6	L1 in mm (inch)	Weight in kg (lb)	L1 in mm (inch)	Weight in kg (lb)	L1 in mm (inch)	Weight in kg (lb)	L1 in mm (inch)	Weight in kg (lb)
ASME 1" class 150	25	BA1	390 (15.4)	11.2 (25)	–	–	–	–	–	–
ASME 1" class 300		BA2	390 (15.4)	12.4 (27)	–	–	–	–	–	–
ASME 1" class 600		BA4	390 (15.4)	12.4 (27)	–	–	–	–	–	–
ASME 1½" class 150	40	BA1	390 (15.4)	12.6 (28)	520 (20.5)	16.5 (36)	–	–	–	–
ASME 1½" class 300		BA2	390 (15.4)	15.2 (33)	520 (20.5)	19.1 (42)	–	–	–	–
ASME 1½" class 600		BA4	400 (15.7)	15.6 (34)	530 (20.9)	19.6 (43)	–	–	–	–
ASME 2" class 150	50	BA1	390 (15.4)	14.8 (33)	520 (20.5)	18.5 (41)	620 (24.4)	27.3 (60)	–	–
ASME 2" class 300		BA2	390 (15.4)	16.2 (36)	520 (20.5)	20.1 (44)	620 (24.4)	28.9 (64)	–	–
ASME 2" class 600		BA4	410 (16.1)	17.6 (39)	540 (21.3)	21.6 (44)	630 (24.8)	29.7 (66)	–	–
ASME 2½" class 150	65	BA1	–	–	–	–	620 (24.4)	30.9 (68)	–	–
ASME 2½" class 300		BA2	–	–	–	–	620 (24.4)	32.5 (72)	–	–
ASME 2½" class 600		BA4	–	–	–	–	640 (25.2)	33.9 (75)	–	–
ASME 3" class 150	80	BA1	–	–	–	–	620 (24.4)	32.8 (72)	1020 (40.2)	61.1 (135)
ASME 3" class 300		BA2	–	–	–	–	620 (24.4)	36.6 (81)	1020 (40.2)	64.5 (142)
ASME 3" class 600		BA4	–	–	–	–	640 (25.2)	38.7 (85)	1020 (40.2)	65.9 (145)

Process connections	MS code pos.		Supreme 34		Supreme 36		Supreme 38		Supreme 39	
	5	6	L1 in mm (inch)	Weight in kg (lb)	L1 in mm (inch)	Weight in kg (lb)	L1 in mm (inch)	Weight in kg (lb)	L1 in mm (inch)	Weight in kg (lb)
ASME 4" class 150	1H	BA1	-	-	-	-	-	-	1020 (40.2)	66.2 (146)
ASME 4" class 300		BA2	-	-	-	-	-	-	1020 (40.2)	74.8 (165)
ASME 4" class 600		BA4	-	-	-	-	-	-	1030 (40.6)	84.1 (185)
ASME 5" class 150	1Q	BA1	-	-	-	-	-	-	1020 (40.2)	70.1 (155)
ASME 5" class 300		BA2	-	-	-	-	-	-	1020 (40.2)	83.3 (184)
ASME 5" class 600		BA4	-	-	-	-	-	-	1040 (40.9)	108.2 (238)

Meaning of "-": not available

Process connections suitable for EN 1092-1

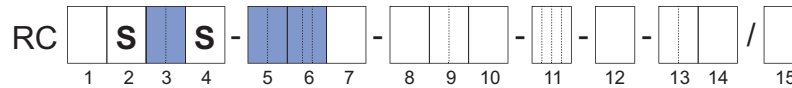

Tab. 18: Overall length L1 and weight of sensor (process connections: EN, wetted parts: stainless steel)

Process connections	MS code pos.		Supreme 34		Supreme 36		Supreme 38		Supreme 39	
	5	6	L1 in mm (inch)	Weight in kg (lb)	L1 in mm (inch)	Weight in kg (lb)	L1 in mm (inch)	Weight in kg (lb)	L1 in mm (inch)	Weight in kg (lb)
EN DN15 PN40, profile B1	15	BD4	370 (14.6)	10.6 (23)	-	-	-	-	-	-
EN DN15 PN40, profile D, with safety groove		GD4	370 (14.6)	10.4 (23)	-	-	-	-	-	-
EN DN15 PN40, profile E, with spigot		ED4	370 (14.6)	10.4 (23)	-	-	-	-	-	-
EN DN15 PN40, profile F, with recess		FD4	370 (14.6)	10.4 (23)	-	-	-	-	-	-
EN DN15 PN100, profile B1		BD6	380 (15)	11.4 (25)	-	-	-	-	-	-
EN DN15 PN100, profile D, with safety groove		GD6	380 (15)	17.4 (38)	-	-	-	-	-	-
EN DN15 PN100, profile E, with spigot		ED6	380 (15)	11.2 (25)	-	-	-	-	-	-
EN DN15 PN100, profile F, with recess		FD6	380 (15)	11.4 (25)	-	-	-	-	-	-

Mechanical specification

Process connections	MS code pos.		Supreme 34		Supreme 36		Supreme 38		Supreme 39	
	5	6	L1 in mm (inch)	Weight in kg (lb)	L1 in mm (inch)	Weight in kg (lb)	L1 in mm (inch)	Weight in kg (lb)	L1 in mm (inch)	Weight in kg (lb)
EN DN25 PN40, profile B1	25	BD4	370 (14.6)	11.6 (26)	500 (19.7)	15.6 (34)	–	–	–	–
EN DN25 PN40, profile D, with safety groove		GD4	370 (14.6)	11.4 (25)	500 (19.7)	15.4 (34)	–	–	–	–
EN DN25 PN40, profile E, with spigot		ED4	370 (14.6)	11.2 (25)	500 (19.7)	15.2 (34)	–	–	–	–
EN DN25 PN40, profile F, with recess		FD4	370 (14.6)	11.4 (25)	500 (19.7)	15.4 (34)	–	–	–	–
EN DN25 PN100, profile B1		BD6	390 (15.4)	14 (31)	520 (20.5)	18.2 (40)	–	–	–	–
EN DN25 PN100, profile D, with safety groove		GD6	390 (15.4)	14 (31)	520 (20.5)	18 (40)	–	–	–	–
EN DN25 PN100, profile E, with spigot		ED6	390 (15.4)	13.6 (30)	520 (20.5)	17.6 (39)	–	–	–	–
EN DN25 PN100, profile F, with recess		FD6	390 (15.4)	14 (31)	520 (20.5)	18 (40)	–	–	–	–
EN DN40 PN40, profile B1	40	BD4	370 (14.6)	13 (29)	500 (19.7)	17 (37)	600 (23.6)	26.2 (58)	–	–
EN DN40 PN40, profile D, with safety groove		GD4	370 (14.6)	13 (29)	500 (19.7)	17 (37)	600 (23.6)	26 (57)	–	–
EN DN40 PN40, profile E, with spigot		ED4	370 (14.6)	12.6 (28)	500 (19.7)	16.6 (37)	600 (23.6)	25.8 (57)	–	–
EN DN40 PN40, profile F, with recess		FD4	370 (14.6)	12.8 (28)	500 (19.7)	16.8 (37)	600 (23.6)	26 (57)	–	–
EN DN40 PN100, profile B1		BD6	450 (17.7)	17.6 (39)	560 (22)	21.2 (47)	620 (24.4)	29.8 (66)	–	–
EN DN40 PN100, profile D, with safety groove		GD6	450 (17.7)	17.4 (38)	560 (22)	21.2 (47)	620 (24.4)	29.6 (65)	–	–
EN DN40 PN100, profile E, with spigot		ED6	450 (17.7)	17 (37)	560 (22)	20.8 (46)	620 (24.4)	29.2 (64)	–	–
EN DN40 PN100, profile F, with recess		FD6	450 (17.7)	17.4 (38)	560 (22)	21 (46)	620 (24.4)	29.6 (65)	–	–

Process connections	MS code pos.		Supreme 34		Supreme 36		Supreme 38		Supreme 39	
	5	6	L1 in mm (inch)	Weight in kg (lb)	L1 in mm (inch)	Weight in kg (lb)	L1 in mm (inch)	Weight in kg (lb)	L1 in mm (inch)	Weight in kg (lb)
EN DN50 PN40, profile B1	50	BD4	–	–	500 (19.7)	18.4 (41)	600 (23.6)	27.4 (60)	–	–
EN DN50 PN40, profile D, with safety groove		GD4	–	–	500 (19.7)	18.2 (40)	600 (23.6)	27.4 (60)	–	–
EN DN50 PN40, profile E, with spigot		ED4	–	–	500 (19.7)	18 (40)	600 (23.6)	27 (60)	–	–
EN DN50 PN40, profile F, with recess		FD4	–	–	500 (19.7)	18.2 (40)	600 (23.6)	27.2 (60)	–	–
EN DN50 PN63, profile B1		BD5	–	–	520 (20.5)	21.6 (48)	620 (24.4)	30.6 (67)	–	–
EN DN50 PN63, profile D, with safety groove		GD5	–	–	520 (20.5)	21.4 (47)	620 (24.4)	30.4 (67)	–	–
EN DN50 PN63, profile E, with spigot		ED5	–	–	520 (20.5)	21 (46)	620 (24.4)	30 (66)	–	–
EN DN50 PN63, profile F, with recess		FD5	–	–	520 (20.5)	21.2 (47)	620 (24.4)	30.2 (67)	–	–
EN DN50 PN100, profile B1		BD6	–	–	590 (23.2)	25.2 (56)	660 (26)	33.6 (74)	–	–
EN DN50 PN100, profile D, with safety groove		GD6	–	–	590 (23.2)	25 (55)	660 (26)	33.4 (74)	–	–
EN DN50 PN100, profile E, with spigot		ED6	–	–	590 (23.2)	24.4 (54)	660 (26)	33 (73)	–	–
EN DN50 PN100, profile F, with recess		FD6	–	–	590 (23.2)	24.8 (55)	660 (26)	33.4 (74)	–	–
EN DN80 PN40, profile B1	80	BD4	–	–	–	–	610 (24)	31 (68)	1000 (39.4)	60.4 (133)
EN DN80 PN40, profile D, with safety groove		GD4	–	–	–	–	610 (24)	30.8 (68)	1000 (39.4)	60.2 (133)
EN DN80 PN40, profile E, with spigot		ED4	–	–	–	–	610 (24)	30.4 (67)	1000 (39.4)	59.8 (132)
EN DN80 PN40, profile F, with recess		FD4	–	–	–	–	610 (24)	30.6 (67)	1000 (39.4)	60 (132)
EN DN80 PN63, profile B1		BD5	–	–	–	–	620 (24.4)	34.4 (76)	1000 (39.4)	63.4 (140)
EN DN80 PN63, profile D, with safety groove		GD5	–	–	–	–	620 (24.4)	34.2 (75)	1000 (39.4)	63.2 (139)
EN DN80 PN63, profile E, with spigot		ED5	–	–	–	–	620 (24.4)	33.6 (74)	1000 (39.4)	62.8 (138)
EN DN80 PN63, profile F, with recess		FD5	–	–	–	–	620 (24.4)	33.8 (75)	1000 (39.4)	63 (139)
EN DN80 PN100, profile B1		BD6	–	–	–	–	730 (28.7)	41.8 (92)	1000 (39.4)	67.2 (148)
EN DN80 PN100, profile D, with safety groove		GD6	–	–	–	–	730 (28.7)	41.6 (92)	1000 (39.4)	67 (148)
EN DN80 PN100, profile E, with spigot		ED6	–	–	–	–	730 (28.7)	41 (90)	1000 (39.4)	66.4 (146)
EN DN80 PN100, profile F, with recess		FD6	–	–	–	–	730 (28.7)	41.4 (91)	1000 (39.4)	66.6 (147)

Process connections	MS code pos.		Supreme 34		Supreme 36		Supreme 38		Supreme 39	
	5	6	L1 in mm (inch)	Weight in kg (lb)	L1 in mm (inch)	Weight in kg (lb)	L1 in mm (inch)	Weight in kg (lb)	L1 in mm (inch)	Weight in kg (lb)
EN DN100 PN40, profile B1	1H	BD4	–	–	–	–	–	–	1000 (39.4)	63.6 (140)
EN DN100 PN40, profile D, with safety groove		GD4	–	–	–	–	–	–	1000 (39.4)	63.2 (139)
EN DN100 PN40, profile E, with spigot		ED4	–	–	–	–	–	–	1000 (39.4)	62.4 (138)
EN DN100 PN40, profile F, with recess		FD4	–	–	–	–	–	–	1000 (39.4)	62.6 (138)
EN DN100 PN63, profile B1		BD5	–	–	–	–	–	–	1000 (39.4)	68 (150)
EN DN100 PN63, profile D, with safety groove		GD5	–	–	–	–	–	–	1000 (39.4)	67.8 (149)
EN DN100 PN63, profile E, with spigot		ED5	–	–	–	–	–	–	1000 (39.4)	67 (148)
EN DN100 PN63, profile F, with recess		FD5	–	–	–	–	–	–	1000 (39.4)	67.4 (149)
EN DN100 PN100, profile B1		BD6	–	–	–	–	–	–	1050 (41.3)	76.6 (169)
EN DN100 PN100, profile D, with safety groove		GD6	–	–	–	–	–	–	1050 (41.3)	76.2 (168)
EN DN100 PN100, profile E, with spigot		ED6	–	–	–	–	–	–	1050 (41.3)	75.4 (166)
EN DN100 PN100, profile F, with recess		FD6	–	–	–	–	–	–	1050 (41.3)	75.8 (167)
EN DN125 PN40, profile B1	1Q	BD4	–	–	–	–	–	–	1000 (39.4)	67.6 (149)
EN DN125 PN40, profile D, with safety groove		GD4	–	–	–	–	–	–	1000 (39.4)	67.2 (148)
EN DN125 PN40, profile E, with spigot		ED4	–	–	–	–	–	–	1000 (39.4)	66.4 (146)
EN DN125 PN40, profile F, with recess		FD4	–	–	–	–	–	–	1000 (39.4)	66.6 (147)
EN DN125 PN63, profile B1		BD5	–	–	–	–	–	–	1000 (39.4)	77.8 (172)
EN DN125 PN63, profile D, with safety groove		GD5	–	–	–	–	–	–	1000 (39.4)	77.4 (171)
EN DN125 PN63, profile E, with spigot		ED5	–	–	–	–	–	–	1000 (39.4)	76.4 (168)
EN DN125 PN63, profile F, with recess		FD5	–	–	–	–	–	–	1000 (39.4)	76.8 (169)
EN DN125 PN100, profile B1		BD6	–	–	–	–	–	–	1100 (43.3)	93.2 (205)
EN DN125 PN100, profile D, with safety groove		GD6	–	–	–	–	–	–	1100 (43.3)	92.8 (205)
EN DN125 PN100, profile E, with spigot		ED6	–	–	–	–	–	–	1100 (43.3)	91.4 (202)
EN DN125 PN100, profile F, with recess		FD6	–	–	–	–	–	–	1100 (43.3)	92.4 (204)

Meaning of "–": not available

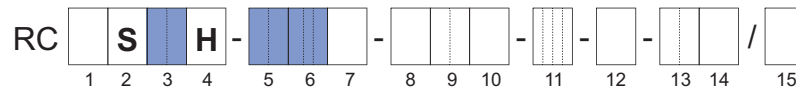

Tab. 19: Overall length L1 and weight of sensor (process connections: EN, wetted parts: Ni alloy C-22/2.4602)

Process connections	MS code pos.		Supreme 34		Supreme 36		Supreme 38		Supreme 39	
	5	6	L1 in mm (inch)	Weight in kg (lb)	L1 in mm (inch)	Weight in kg (lb)	L1 in mm (inch)	Weight in kg (lb)	L1 in mm (inch)	Weight in kg (lb)
EN DN25 PN40, profile B1	25	BD4	390 (15.4)	11.7 (26)	520 (20.5)	15.7 (35)	-	-	-	-
EN DN40 PN40, profile B1	40		390 (15.4)	13.7 (30)	520 (20.5)	17.5 (39)	-	-	-	-
EN DN50 PN40, profile B1	50		-	-	520 (20.5)	19.3 (43)	620 (24.4)	28 (62)	-	-
EN DN80 PN40, profile B1	80		-	-	-	-	620 (24.4)	32.6 (72)	1020 (40.2)	60.8 (134)
EN DN100 PN40, profile B1	1H		-	-	-	-	-	-	1020 (40.2)	65.1 (144)
EN DN125 PN40, profile B1	1Q		-	-	-	-	-	-	1020 (40.2)	71.4 (157)

Meaning of "-": not available

Process connections suitable for JIS B 2220

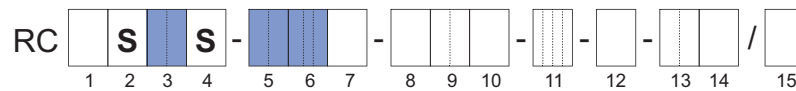

Tab. 20: Overall length L1 and weight of sensor (process connections: JIS, wetted parts: stainless steel)

Process connections	MS code pos.		Supreme 34		Supreme 36		Supreme 38		Supreme 39	
	5	6	L1 in mm (inch)	Weight in kg (lb)	L1 in mm (inch)	Weight in kg (lb)	L1 in mm (inch)	Weight in kg (lb)	L1 in mm (inch)	Weight in kg (lb)
JIS DN15 10K	15	BJ1	370 (14.6)	10.4 (23)	-	-	-	-	-	-
JIS DN15 20K		BJ2	370 (14.6)	10.4 (23)	-	-	-	-	-	-
JIS DN25 10K	25	BJ1	370 (14.6)	11.4 (25)	500 (19.7)	15.6 (34)	-	-	-	-
JIS DN25 20K		BJ2	370 (14.6)	11.8 (26)	500 (19.7)	15.8 (35)	-	-	-	-
JIS DN40 10K	40	BJ1	370 (14.6)	12.2 (27)	500 (19.7)	16.2 (36)	600 (23.6)	25.4 (56)	-	-
JIS DN40 20K		BJ2	370 (14.6)	12.6 (28)	500 (19.7)	16.6 (37)	600 (23.6)	25.8 (57)	-	-
JIS DN50 10K	50	BJ1	-	-	500 (19.7)	17 (37)	600 (23.6)	26 (57)	-	-
JIS DN50 20K		BJ2	-	-	500 (19.7)	17.2 (38)	600 (23.6)	26.2 (58)	-	-
JIS DN80 10K	80	BJ1	-	-	-	-	600 (23.6)	27.8 (61)	1000 (39.4)	57.8 (127)
JIS DN80 20K		BJ2	-	-	-	-	610 (24)	30.4 (67)	1000 (39.4)	60 (132)
JIS DN100 10K	1H	BJ1	-	-	-	-	-	-	1000 (39.4)	59 (130)
JIS DN100 20K		BJ2	-	-	-	-	-	-	1000 (39.4)	63 (139)

Process connections	MS code pos.		Supreme 34		Supreme 36		Supreme 38		Supreme 39	
	5	6	L1 in mm (inch)	Weight in kg (lb)	L1 in mm (inch)	Weight in kg (lb)	L1 in mm (inch)	Weight in kg (lb)	L1 in mm (inch)	Weight in kg (lb)
JIS DN125 10K	1Q	BJ1	–	–	–	–	–	–	1000 (39.4)	62.8 (138)
JIS DN125 20K		BJ2	–	–	–	–	–	–	1000 (39.4)	69 (152)

Meaning of "–": not available

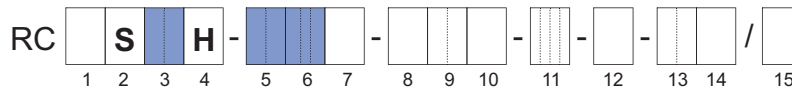

Tab. 21: Overall length L1 and weight of sensor (process connections: JIS, wetted parts: Ni alloy C-22/2.4602)

Process connections	MS code pos.		Supreme 34		Supreme 36		Supreme 38		Supreme 39	
	5	6	L1 in mm (inch)	Weight in kg (lb)	L1 in mm (inch)	Weight in kg (lb)	L1 in mm (inch)	Weight in kg (lb)	L1 in mm (inch)	Weight in kg (lb)
JIS DN25 10K	25	BJ1	390 (15.4)	12.1 (27)	–	–	–	–	–	–
JIS DN25 20K		BJ2	390 (15.4)	12.5 (28)	–	–	–	–	–	–
JIS DN40 10K	40	BJ1	390 (15.4)	13.6 (30)	520 (20.5)	17.4 (38)	–	–	–	–
JIS DN40 20K		BJ2	390 (15.4)	14 (31)	520 (20.5)	17.6 (39)	–	–	–	–
JIS DN50 10K	50	BJ1	–	–	520 (20.5)	18.6 (41)	620 (24.4)	27.3 (60)	–	–
JIS DN50 20K		BJ2	–	–	520 (20.5)	18.8 (41)	620 (24.4)	27.3 (60)	–	–
JIS DN80 10K	80	BJ1	–	–	–	–	620 (24.4)	30.8 (68)	1020 (40.2)	58.8 (130)
JIS DN80 20K		BJ2	–	–	–	–	620 (24.4)	33.3 (73)	1020 (40.2)	61.3 (135)
JIS DN100 10K	1H	BJ1	–	–	–	–	–	–	1020 (40.2)	62.5 (138)
JIS DN100 20K		BJ2	–	–	–	–	–	–	1020 (40.2)	66.7 (147)
JIS DN125 10K	1Q	BJ1	–	–	–	–	–	–	1020 (40.2)	69.6 (153)
JIS DN125 20K		BJ2	–	–	–	–	–	–	1020 (40.2)	76.5 (169)

Meaning of "–": not available

Process connections suitable for JPI

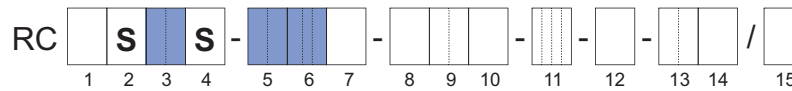

Tab. 22: Overall length L1 and weight of sensor (process connections: JPI, wetted parts: stainless steel)

Process connections	MS code pos.		Supreme 34		Supreme 36		Supreme 38		Supreme 39	
	5	6	L1 in mm (inch)	Weight in kg (lb)	L1 in mm (inch)	Weight in kg (lb)	L1 in mm (inch)	Weight in kg (lb)	L1 in mm (inch)	Weight in kg (lb)
JPI ½" class 150	15	BP1	370 (14.6)	10 (22)	-	-	-	-	-	-
JPI ½" class 300		BP2	370 (14.6)	10.4 (23)	-	-	-	-	-	-
JPI ½" class 600		BP4	380 (15)	10.6 (23)	-	-	-	-	-	-
JPI 1" class 150	25	BP1	370 (14.6)	10.8 (24)	500 (19.7)	14.8 (33)	-	-	-	-
JPI 1" class 300		BP2	370 (14.6)	11.8 (26)	500 (19.7)	15.8 (35)	-	-	-	-
JPI 1" class 600		BP4	390 (15.4)	12.2 (27)	520 (20.5)	16.2 (36)	-	-	-	-
JPI 1½" class 150	40	BP1	380 (15)	12 (26)	500 (19.7)	16 (35)	600 (23.6)	25 (55)	-	-
JPI 1½" class 300		BP2	380 (15)	14 (31)	510 (20.1)	18.2 (40)	600 (23.6)	27 (60)	-	-
JPI 1½" class 600		BP4	400 (15.7)	15.2 (34)	530 (20.9)	19.2 (42)	620 (24.4)	28.2 (62)	-	-
JPI 2" class 150	50	BP1	-	-	510 (20.1)	17.4 (38)	600 (23.6)	26.6 (59)	-	-
JPI 2" class 300		BP2	-	-	510 (20.1)	19.4 (43)	600 (23.6)	28 (62)	-	-
JPI 2" class 600		BP4	-	-	540 (21.3)	20.6 (45)	630 (24.8)	29.6 (65)	-	-
JPI 2½" class 150	65	BP1	-	-	-	-	610 (24)	29.2 (64)	-	-
JPI 2½" class 300		BP2	-	-	-	-	610 (24)	30.8 (68)	-	-
JPI 2½" class 600		BP4	-	-	-	-	640 (25.2)	33 (73)	-	-
JPI 3" class 150	80	BP1	-	-	-	-	610 (24)	30.6 (67)	1000 (39.4)	60 (132)
JPI 3" class 300		BP2	-	-	-	-	620 (24.4)	34.2 (75)	1000 (39.4)	63.4 (140)
JPI 3" class 600		BP4	-	-	-	-	640 (25.2)	37.2 (82)	1000 (39.4)	65.4 (144)
JPI 4" class 150	1H	BP1	-	-	-	-	-	-	1000 (39.4)	63.6 (140)
JPI 4" class 300		BP2	-	-	-	-	-	-	1000 (39.4)	71.2 (157)
JPI 4" class 600		BP4	-	-	-	-	-	-	1030 (40.6)	81.2 (179)
JPI 5" class 150	1Q	BP1	-	-	-	-	-	-	1000 (39.4)	65.2 (144)
JPI 5" class 300		BP2	-	-	-	-	-	-	1000 (39.4)	77 (170)

Meaning of "-": not available

Process connections with internal thread

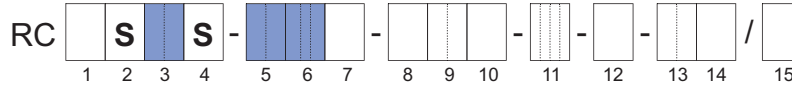

Tab. 23: Overall length L1 and weight of sensor (process connections: G thread, wetted parts: stainless steel)

Internal thread	MS code pos.		Supreme 34		Supreme 36		Supreme 38		Supreme 39	
	5	6	L1 in mm (inch)	Weight in kg (lb)	L1 in mm (inch)	Weight in kg (lb)	L1 in mm (inch)	Weight in kg (lb)	L1 in mm (inch)	Weight in kg (lb)
G 3/8"	08	TG9	390 (15.4)	9.4 (21)	-	-	-	-	-	-
G 1/2"	15		390 (15.4)	9.4 (21)	-	-	-	-	-	-
G 3/4"	20		390 (15.4)	9.4 (21)	-	-	-	-	-	-

Meaning of "-": not available

Process connections with internal thread

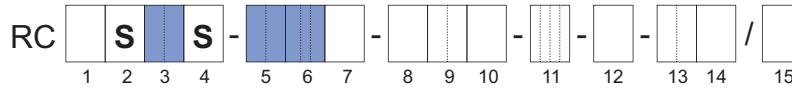

Tab. 24: Overall length L1 and weight of sensor (process connections: NPT thread, wetted parts: stainless steel)

Internal thread	MS code pos.		Supreme 34		Supreme 36		Supreme 38		Supreme 39	
	5	6	L1 in mm (inch)	Weight in kg (lb)	L1 in mm (inch)	Weight in kg (lb)	L1 in mm (inch)	Weight in kg (lb)	L1 in mm (inch)	Weight in kg (lb)
NPT 3/8"	08	TT9	390 (15.4)	9.4 (21)	-	-	-	-	-	-
NPT 1/2"	15		390 (15.4)	9.4 (21)	-	-	-	-	-	-
NPT 3/4"	20		390 (15.4)	9.4 (21)	-	-	-	-	-	-

Meaning of "-": not available

6.4 Transmitter dimensions and weights

Transmitter dimensions

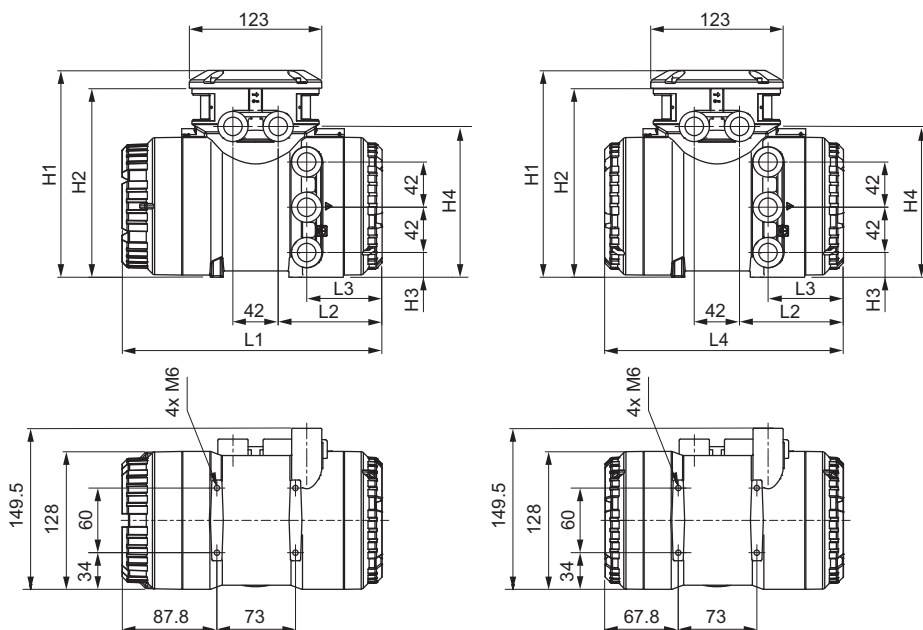

Fig. 26: Dimensions of transmitter in mm (left: transmitter with display, right: transmitter without display)

Material	L1 in mm (inch)	L2 in mm (inch)	L3 in mm (inch)	L4 in mm (inch)	H1 in mm (inch)	H2 in mm (inch)	H3 in mm (inch)	H4 in mm (inch)
Stainless steel	255.5 (10.06)	110.5 (4.35)	69 (2.72)	235 (9.25)	201 (7.91)	184 (7.24)	24 (0.94)	150.5 (5.93)
Aluminum	241.5 (9.51)	96.5 (3.8)	70 (2.76)	221 (8.7)	192 (7.56)	175 (6.89)	23 (0.91)	140 (5.51)

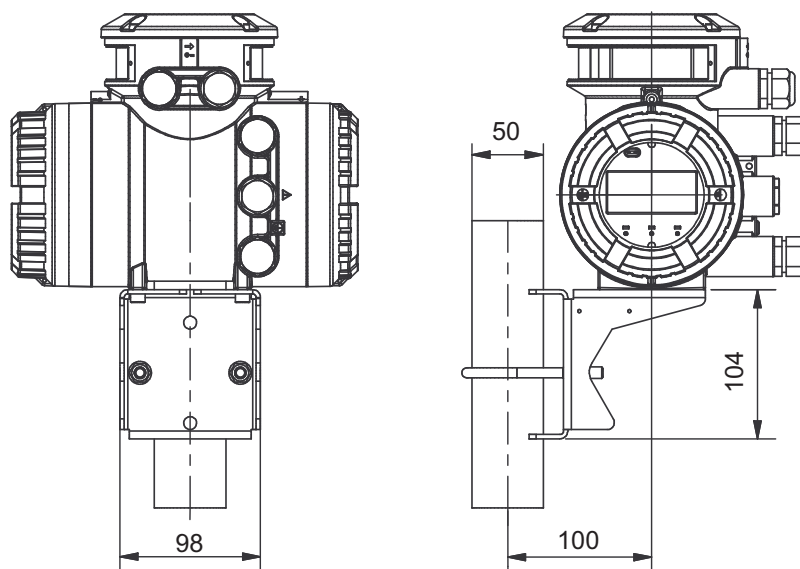
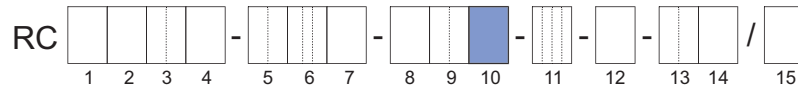

Fig. 27: Dimensions of transmitter in mm, attached by sheet metal console (bracket)



Transmitter weights

MS code (Position 10)	Design	Housing material of transmitter	Weight in kg (lb)
A, B, E, F	Remote	Aluminum	4.2 (9.3)
J, K		Stainless steel	12.5 (27.6)

7 Transmitter specification

Overview of functional scope of the Rotamass transmitter

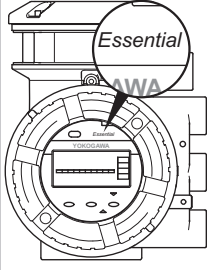
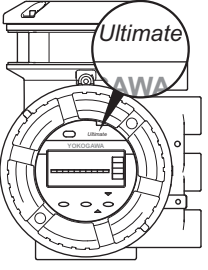
Functional scope	Transmitter	
	Essential	Ultimate
		
MS code (Position 1)	E	U
4-line Dot-Matrix display	•	•
Universal power supply (V_{DC} and V_{AC})	•	•
Installation		
Integral type	•	•
Remote type	•	•
Special functions		
Wizard	•	•
Event management	•	•
microSD card	•	•
Total-Health-Check	•	•
Special functions for applications		
Dynamic pressure compensation ¹⁾	–	•
Inline concentration measurement	–	•
Measurement of heat quantity ¹⁾	–	•
Inputs and outputs		
Analog output	•	•
Pulse/frequency output	•	•
Status output	•	•
Analog input	–	•
Status input	•	•
Communication		
HART	•	•
Modbus	•	•

¹⁾ Only in combination with an analog input

7.1 Inputs and outputs

Depending on the flow meter specification, there are different configurations of the connection terminal. Following are configuration examples of the connection terminal (value JK and M7 on MS code position 13 - see *Inputs and outputs* [p. 94] for details):

HART

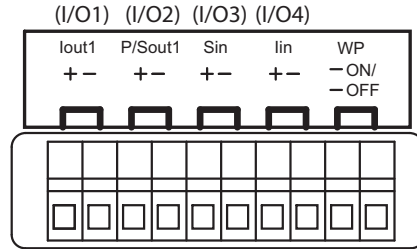

- I/O1: Current output (active/passive)
Iout1
- I/O2: P/ Pulse or status output (passive)
Sout1
- I/O3: Status input
Sin
- I/O4: Iin Current input (active/passive)
- WP Write-protect bridge

Modbus

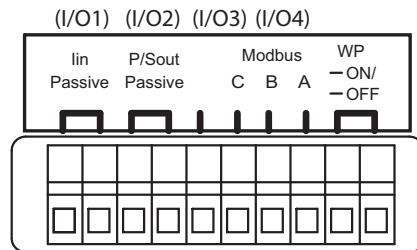

- I/O1: Iin Current input (passive)
- I/O2: P/ Pulse or status output (passive)
Sout
- I/O3-I/ RS485 input/output
O4:
- Modbus
- WP Write-protect bridge

7.1.1 Output signals

Galvanic isolation

All circuits for inputs, outputs and power supply are galvanically isolated from each other.

Active current output *lout*

One or two current outputs are available depending on MS code position 13.

Depending on the measured value, the active current output delivers 4 - 20 mA.

It may be used for output of the following measured values:

- Flow rate (mass, volume, net partial component flow of a mixture)
- Density
- Temperature
- Pressure
- Concentration

For HART communication devices, it is supplied on the current output *lout1*. The current output may be operated in compliance with the NAMUR NE43 standard.

	Value
Nominal output current	4 – 20 mA
Maximum output current range	2.4 – 21.6 mA
Load resistance	≤ 750 Ω
Load resistance for secure HART communication	230 – 600 Ω
Additive maximum deviation	8 μA
Additive output deviation for deviation from 20 °C ambient temperature	0.8 μA/°C

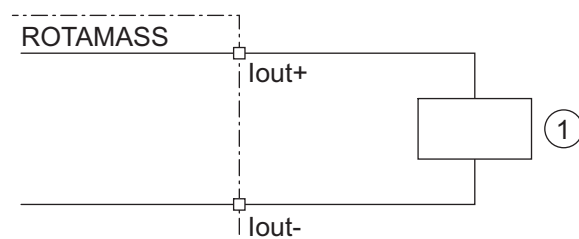

Fig. 28: Active current output connection *lout* HART

① Receiver

Passive current output *I_{out}*

	Value
Nominal output current	4 – 20 mA
Maximum output current range	2.4 – 21.6 mA
External power supply	10.5 – 32 V _{DC}
Load resistance for secure HART communication	230 – 600 Ω
Load resistance at current output	≤ 911 Ω
Additive maximum deviation	8 μA
Additive output deviation for deviation from 20 °C ambient temperature	0.8 μA/°C

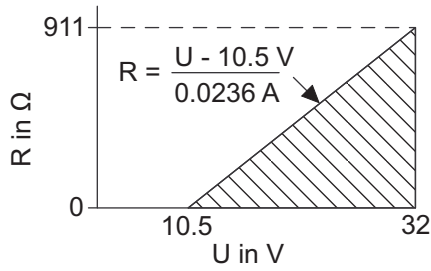

Fig. 29: Maximum load resistance as a function of an external power supply voltage

- R Load resistance
- U External power supply voltage

The diagram shows the maximum load resistance R as a function of voltage U of the connected voltage source. Higher load resistances are allowed with higher power supply values. The usable zone for passive power output operation is indicated by the hatched area.

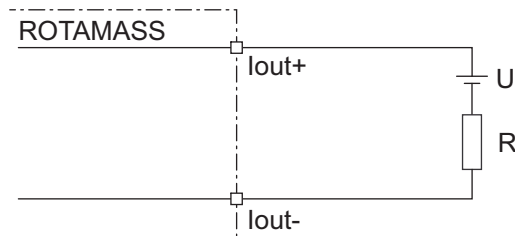

Fig. 30: Passive current output connection *I_{out}*

Active pulse output
P/Sout

Connection of an electronic counter

Maximum voltage and correct polarity must be observed for wiring.

	Value
Load resistance	> 1 kΩ
Internal power supply	24 V _{DC} ±20 %
Maximum pulse rate	10000 pulses/s
Frequency range	0 – 12.5 kHz

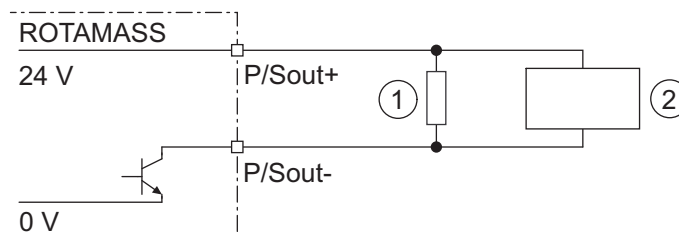

Fig. 31: Active pulse output connection *P/Sout*

- ① Load resistance
- ② Electronic counter

Connection of an electromechanical counter

	Value
Maximum current	150 mA
Average current	≤ 30 mA
Internal power supply	24 V _{DC} ±20 %
Maximum pulse rate	2 pulses/s
Pulse width	20, 33, 50, 100 ms

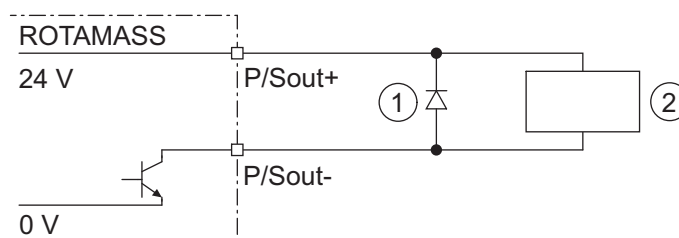

Fig. 32: Active pulse output *P/Sout* connection with electromechanical counter

- ① Protective diode
- ② Electromechanical counter

Active pulse output P/Sout with internal pull-up resistor

	Value
Internal power supply	24 V _{DC} ±20 %
Internal pull-up resistor	2.2 kΩ
Maximum pulse rate	10000 pulses/s
Frequency range	0 – 12.5 kHz

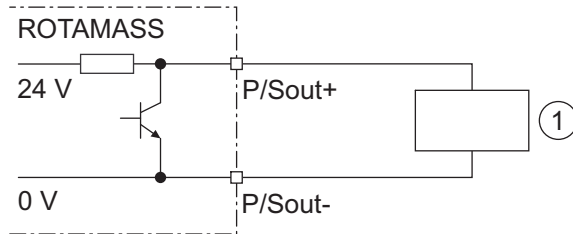

Fig. 33: Active pulse output P/Sout with internal pull-up resistor

- ① Electronic counter

Passive pulse output P/Sout

Maximum voltage and correct polarity must be observed for wiring.

	Value
Maximum load current	≤ 200 mA
Power supply	≤ 30 V _{DC}
Maximum pulse rate	10000 pulses/s
Frequency range	0 – 12.5 kHz

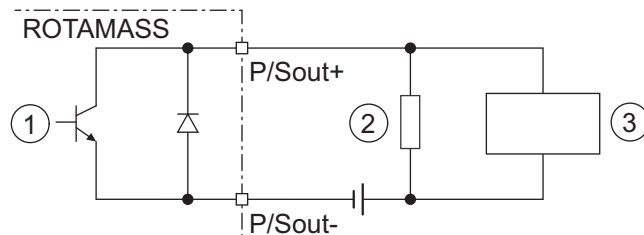

Fig. 34: Passive pulse output connection P/Sout with electronic counter

- ① Passive pulse or status output
- ② Load resistance
- ③ Electronic counter

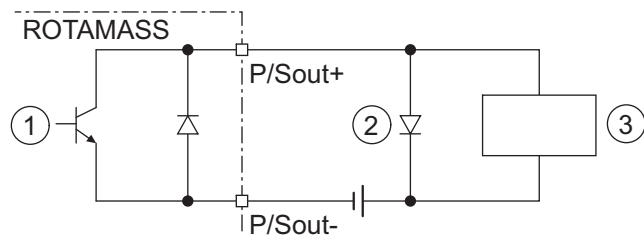

Fig. 35: Passive pulse output P/Sout connection with electromechanical counter

- ① Passive pulse or status output
- ② Protective diode
- ③ Electromechanical counter

Active status output P/Sout

Since this is a transistor contact, maximum allowed current as well as polarity and level of output voltage must be observed during wiring.

	Value
Load resistance	> 1 kΩ
Internal power supply	24 V _{DC} ±20 %

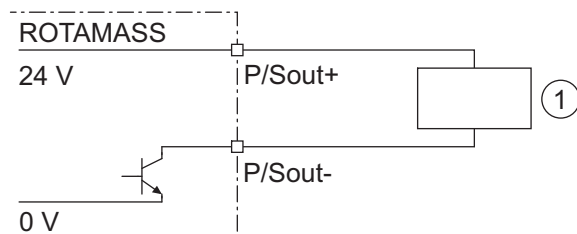

Fig. 36: Active status output connection P/Sout

- ① External device with load resistance

Active status output P/Sout with internal pull-up resistor

	Value
Internal pull-up resistor	2.2 kΩ
Internal power supply	24 V _{DC} ±20 %

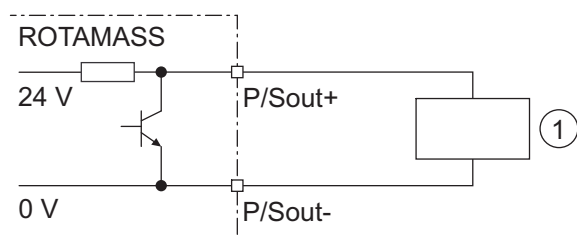

Fig. 37: Active status output P/Sout with internal pull-up resistor

- ① External device

Passive status output P/Sout

	Value
Output current	≤ 200 mA
Power supply	≤ 30 V _{DC}

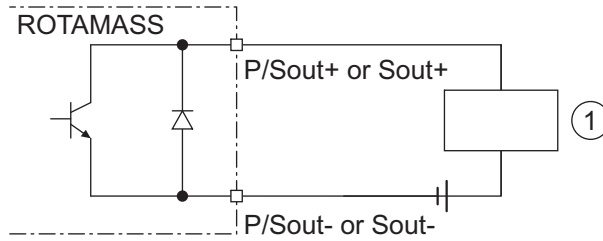

Fig. 38: Passive status output connection P/Sout

- ① External device

A relay must be connected in series to switch alternating voltage.

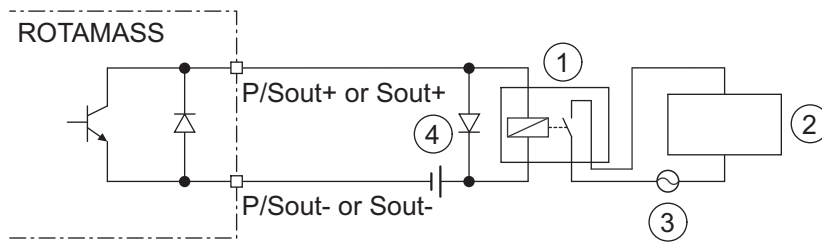

Fig. 39: Passive status output connection P/Sout for solenoid valve circuit

- ① Relay
- ② Solenoid valve
- ③ Magnetic valve power supply
- ④ Protective diode

Passive pulse or status output P/Sout (NAMUR)

According to EN 60947-5-6 (previously NAMUR, worksheet NA001)

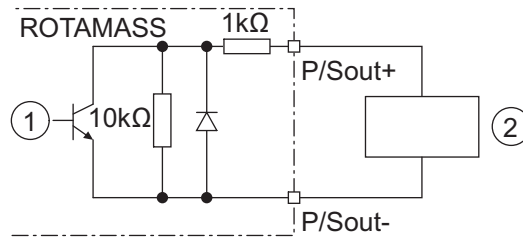

Fig. 40: Passive pulse or status output with switching amplifier connected in series

- ① Passive pulse or status output
- ② Switching amplifier

7.1.2 Input signals

Active current input *lin*

An individual analog power input is available for external analog devices.

The active current input *lin* is provided for connecting a two-wire transmitter with an output signal of 4 – 20 mA.

	Value
Nominal input current	4 – 20 mA
Maximum input current range	2.4 – 21.6 mA
Internal power supply	24 V _{DC} ±20 %
Internal load resistance Rotamass	≤ 160 Ω

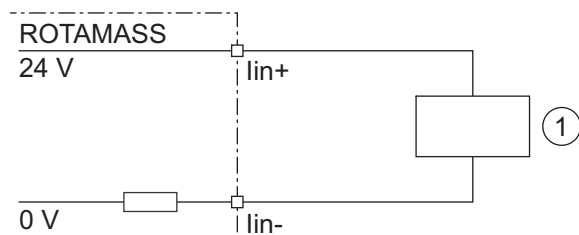

Fig. 41: Connection of external device with passive current output

- ① External passive current output device

Passive current input *lin*

The passive current input *lin* is provided for connecting a four-wire transmitter with an output signal of 4 – 20 mA.

	Value
Nominal input current	4 – 20 mA
Maximum input current range	2.4 – 21.6 mA
Maximum input voltage	≤ 32 V _{DC}
Internal load resistance Rotamass	≤ 160 Ω

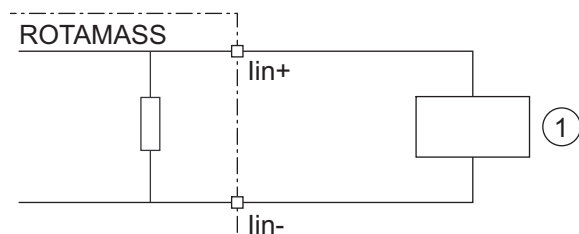

Fig. 42: Connection of external device with active current output

- ① External active current output device

Status input *Sin*



Do not connect a signal source with electric voltage.

The status input is provided for use of voltage-free contacts with the following specification:

Switching status	Resistance
Closed	< 200 Ω
Open	> 100 kΩ

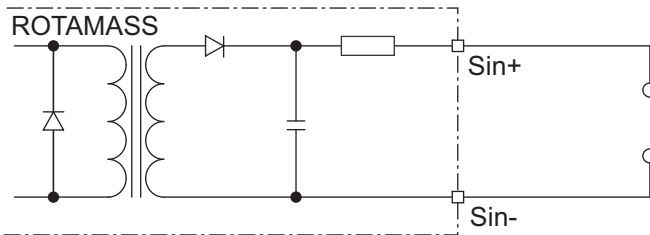

Fig. 43: Status input connection

7.2 Power supply

Power supply

- Alternating voltage (rms):
 - Power supply¹: 24 V_{AC} or 100 – 240 V_{AC}
 - Power frequency: 47 – 63 Hz
 - Power supply voltage tolerance: - 15 %, + 10 %
- Direct-current voltage:
 - Power supply¹: 24 V_{DC} or 100 – 120 V_{DC}
 - Power supply voltage tolerance: ± 20 %

¹for option MC_ (DNV GL approval) supply voltage is limited to 24V

Power consumption

- P = 10 W (including sensor)

Power supply failure

In the event of a power failure, the flow meter data are backed up on a non-volatile internal memory. In case of devices with display, the characteristic sensor values, such as nominal diameter, serial number, calibration constants, Zero point, etc. and the error history are also stored on a microSD card.

7.3 Cable specification

With the remote type, the original connecting cable from Rota Yokogawa must be used to connect the sensor with the transmitter. The connecting cable included in the delivery may be shortened. An assembly set along with the appropriate instructions are enclosed for this purpose.

The connecting cable can be ordered in various lengths as a standard type (device options L_...) or as marine approved fire retardant cable (device options Y_...), see chapters *Connecting cable type and length* [▶ 97] and *Marine Approval* [▶ 105] for details.



The maximum cable length to keep the specification is 30 m (98.4 ft). Longer cables must be ordered as a separate item.

8 Approvals and declarations of conformity

CE marking	The Rotamass Coriolis flow meter meets the statutory requirements of the applicable EU Directives. By attaching the CE mark, Rota Yokogawa confirms conformity of the field instrument with the requirements of the applicable EU Directives. The EU Declaration of Conformity is enclosed with the product on a data carrier.
RCM	Rotamass Coriolis flow meter meets the EMC requirements of the Australian Communications and Media Authority (ACMA).
Ex approvals	All data relevant for explosion protection are included in separate Ex instruction manuals.
Pressure equipment approvals	The Rotamass Coriolis flow meter is in compliance with the statutory requirements of the applicable EU Pressure Equipment Directive (PED).

Tab. 25: Approvals and certifications

Type	Approval or certification
ATEX	EU Directive 2014/34/EU ATEX approval: DEKRA 15ATEX0023 X CE ₀₃₄₄ II2G or II2(1)G or II2D or II2(1)D Applied standards: <ul style="list-style-type: none"> ▪ EN 60079-0 +A11 ▪ EN 60079-1 ▪ EN 60079-7 ▪ EN 60079-11 ▪ EN 60079-31
	Remote transmitter (depending on the MS code): Ex db [ia Ga] IIC T6 Gb or Ex db e [ia Ga] IIC T6 Gb or Ex db [ia Ga] IIB T6 Gb or Ex db e [ia Ga] IIB T6 Gb Ex db [ia Ga] [ia IIC Ga] IIB T6 Gb or Ex db e [ia Ga] [ia IIC Ga] IIB T6 Gb or Ex tb [ia Da] IIIC T75 °C Db
	Remote sensor (depending on the MS code): Ex ib IIC T6...T1 Gb or Ex ib IIB T6...T1 Gb Ex ib IIIC T150 °C Db or Ex ib IIIC T220 °C Db or Ex ib IIIC T350 °C Db
	Integral type (depending on the MS code): Ex db ib IIC T6...T1 Gb or Ex db e ib IIC T6...T1 Gb or Ex db ib IIB T6...T1 Gb or Ex db e ib IIB T6...T1 Gb or Ex db ib [ia Ga] IIC T6...T1 Gb or Ex db e ib [ia Ga] IIC T6...T1 Gb or Ex db ib [ia IIC Ga] IIB T6...T1 Gb or Ex db e ib [ia IIC Ga] IIB T6...T1 Gb Ex ib tb IIIC T150 °C Db or Ex ib tb [ia Da] IIIC T150 °C Db

Type	Approval or certification
IECEX	IECEx approval: IECEx DEK 15.0016X Applied standards: <ul style="list-style-type: none"> ▪ IEC 60079-0 ▪ IEC 60079-1 ▪ IEC 60079-7 ▪ IEC 60079-11 ▪ IEC 60079-31
	Remote transmitter (depending on the MS code): Ex db [ia Ga] IIC T6 Gb or Ex db e [ia Ga] IIC T6 Gb or Ex db [ia Ga] IIB T6 Gb or Ex db e [ia Ga] IIB T6 Gb Ex db [ia Ga] [ia IIC Ga] IIB T6 Gb or Ex db e [ia Ga] [ia IIC Ga] IIB T6 Gb or Ex tb [ia Da] IIIC T75 °C Db
	Remote sensor (depending on the MS code): Ex ib IIC T6...T1 Gb or Ex ib IIB T6...T1 Gb Ex ib IIIC T150 °C Db or Ex ib IIIC T220 °C Db or Ex ib IIIC T350 °C Db
	Integral type (depending on the MS code): Ex db ib IIC T6...T1 Gb or Ex db e ib IIC T6...T1 Gb or Ex db ib IIB T6...T1 Gb or Ex db e ib IIB T6...T1 Gb or Ex db ib [ia Ga] IIC T6...T1 Gb or Ex db e ib [ia Ga] IIC T6...T1 Gb or Ex db ib [ia IIC Ga] IIB T6...T1 Gb or Ex db e ib [ia IIC Ga] IIB T6...T1 Gb Ex ib tb IIIC T150 °C Db or Ex ib tb [ia Da] IIIC T150 °C Db

Type	Approval or certification
FM (CA/US)	FM approvals: <ul style="list-style-type: none"> ▪ US Cert No. FM16US0095X ▪ CA Cert No. FM16CA0031X
	Applied standards: <ul style="list-style-type: none"> ▪ Class 3600 ▪ Class 3610 ▪ Class 3615 ▪ Class 3810 ▪ Class 3616 ▪ NEMA 250 ▪ ANSI/IEC 60529 ▪ CSA-C22.2 No. 0-10 ▪ CSA-C22.2 No. 0.4-04 ▪ CSA-C22.2 No. 0.5-1982 ▪ CSA-C22.2 No. 94.1-07 ▪ CSA-C22.2 No. 94.2-07 ▪ CAN/CSA-C22.2 No. 60079-0 ▪ CAN/CSA-C22.2 No. 60079-11 ▪ CAN/CSA-C22.2 No. 61010-1-04 ▪ CSA-C22.2 No. 25-1966 ▪ CSA-C22.2 No. 30-M1986 ▪ CSA-C22.2 No. 60529
	Remote transmitter (depending on the MS code): CL I, DIV 1, GP ABCD, CL II/III, DIV 1, GP EFG; CL I ZN 1 GP IIC; Associated Apparatus CL I/II/III DIV 1, GP ABCDEFG; CL I ZN 0 GP IIC Entity Temperature class T6 or CL I, DIV 1, GP ABCD, CL II/III, DIV 1, GP EFG; CL I ZN 1 GP IIC; Associated Apparatus CL I/II/III DIV 1, GP ABCDEFG; CL I ZN 0 GP IIC Temperature class T6; Associated Apparatus CL I/II/III DIV 1, GP ABCDEFG; CL I ZN 0 GP IIC Entity Temperature class T6 or CL I, DIV 1, GP CD, CL II/III, DIV 1, GP EFG; CL I ZN 1 GP IIB; Associated Apparatus CL I/II/III DIV 1, GP CDEFG; CL I ZN 0 GP IIB Entity Temperature class T6 or CL I, DIV 1, GP CD, CL II/III, DIV 1, GP EFG; CL I ZN 1 GP IIB; Associated Apparatus CL I/II/III DIV 1, GP CDEFG; CL I ZN 0 GP IIB Temperature class T6; Associated Apparatus CL I/II/III DIV 1, GP ABCDEFG; CL I ZN 0 GP IIB Entity Temperature class T6
	Remote sensor (depending on the MS code): IS CL I/II/III, DIV 1, GP ABCDEFG; CL I, ZN 0, GP IIC Temperature class T* or IS CL I/II/III, DIV 1, GP ABCDEFG; CL I, ZN 0, GP IIB Temperature class T*

Type	Approval or certification
FM (CA/US)	<p>Integral type (depending on the MS code): CL I, DIV 1, GP ABCD, CL II/III, DIV 1, GP EFG; CL I ZN 1 GP IIC Temperature class T*</p> <p>or</p> <p>CL I, DIV 1, GP ABCD, CL II/III, DIV 1, GP EFG; CL I ZN 1 GP IIC Associated Apparatus CL I/II/III DIV 1 GP ABCDEFG; CL I ZN 0 GP IIC Entity Temperature class T*</p> <p>or</p> <p>CL I, DIV 1, GP CD, CL II/III, DIV 1, GP EFG; CL I ZN 1 GP IIB Temperature class T*</p> <p>or</p> <p>CL I, DIV 1, GP CD, CL II/III, DIV 1, GP EFG; CL I ZN 1 GP IIB Associated Apparatus CL I/II/III DIV 1 GP ABCDEFG; CL I ZN 0 GP IIC Entity Temperature class T*</p>
INMETRO	<p>INMETRO approval: DEKRA 16.0012X</p> <p>Applied standards:</p> <ul style="list-style-type: none"> ▪ ABNT NBR IEC 60079-0 ▪ ABNT NBR IEC 60079-1 ▪ ABNT NBR IEC 60079-7 ▪ ABNT NBR IEC 60079-11 ▪ ABNT NBR IEC 60079-31 <p>Remote transmitter (depending on the MS code): Ex db [ia Ga] IIC T6 Gb or Ex db e [ia Ga] IIC T6 Gb or Ex db [ia Ga] IIB T6 Gb or Ex db e [ia Ga] IIB T6 Gb Ex db [ia Ga] [ia IIC Ga] IIB T6 Gb or Ex db e [ia Ga] [ia IIC Ga] IIB T6 Gb or Ex tb [ia Da] IIIC T75 °C Db</p> <p>Remote sensor (depending on the MS code): Ex ib IIC T6...T1 Gb or Ex ib IIB T6...T1 Gb Ex ib IIIC T150 °C Db or Ex ib IIIC T220 °C Db or Ex ib IIIC T350 °C Db</p> <p>Integral type (depending on the MS code): Ex db ib IIC T6...T1 Gb or Ex db e ib IIC T6...T1 Gb or Ex db ib IIB T6...T1 Gb or Ex db e ib IIB T6...T1 Gb or Ex db ib [ia Ga] IIC T6...T1 Gb or Ex db e ib [ia Ga] IIC T6...T1 Gb or Ex db ib [ia IIC Ga] IIB T6...T1 Gb or Ex db e ib [ia IIC Ga] IIB T6...T1 Gb Ex ib tb IIIC T150 °C Db or Ex ib tb [ia Da] IIIC T150 °C Db</p>

Type	Approval or certification
NEPSI	NEPSI approval GYJ17.1242X Applied standards: <ul style="list-style-type: none"> ▪ GB3836.1 ▪ GB3836.2 ▪ GB3836.3 ▪ GB3836.4 ▪ GB3836.19 ▪ GB3836.20
	Remote transmitter (depending on the MS code): Ex db [ia Ga] IIC T6 Gb or Ex db e [ia Ga] IIC T6 Gb or Ex db [ia Ga] IIB T6 Gb or Ex db e [ia Ga] IIB T6 Gb Ex db [ia Ga] [ia IIC Ga] IIB T6 Gb or Ex db e [ia Ga] [ia IIC Ga] IIB T6 Gb or Ex tb [ia Da] IIIC T75 °C Db
	Remote sensor (depending on the MS code): Ex ib IIC T6...T1 Gb or Ex ib IIB T6...T1 Gb Ex ib IIIC T150 °C Db or Ex ib IIIC T220 °C Db or Ex ib IIIC T350 °C Db
	Integral type (depending on the MS code): Ex db ib IIC T6...T1 Gb or Ex db e ib IIC T6...T1 Gb or Ex db ib IIB T6...T1 Gb or Ex db e ib IIB T6...T1 Gb or Ex db ib [ia Ga] IIC T6...T1 Gb or Ex db e ib [ia Ga] IIC T6...T1 Gb or Ex db ib [ia IIC Ga] IIB T6...T1 Gb or Ex db e ib [ia IIC Ga] IIB T6...T1 Gb Ex ib tb IIIC T150 °C Db or Ex ib tb [ia Da] IIIC T150 °C Db

Type	Approval or certification
PESO	Certificate Number: DEKRA 15ATEX0023 X PESO Equip. Ref. No. P4...: P400958/1 P400964/1 P400966/1 P400967/1 P400969/1 P400970/1 P400971/1 P400972/1 P400973/1
	Applied standards: <ul style="list-style-type: none"> ▪ EN 60079-0 +A11 ▪ IS/IEC 60079-1 ▪ EN 60079-11
	Remote transmitter (depending on the MS code): Ex db [ia Ga] IIC T6 Gb or Ex db [ia Ga] IIB T6 Gb or Ex db [ia Ga] [ia IIC Ga] IIB T6 Gb
	Remote sensor (depending on the MS code): Ex ib IIC T6...T1 Gb or Ex ib IIB T6...T1 Gb
	Integral type (depending on the MS code): Ex db ib IIC T6...T1 Gb or Ex db ib IIB T6...T1 Gb or Ex db ib [ia Ga] IIC T6...T1 Gb or Ex db ib [ia IIC Ga] IIB T6...T1 Gb
Ingress protection	IP66/67 and NEMA 4X
EMC	EU directive 2014/30/EU per EN 61326-1 Class A Table 2 and EN 61326-2-3, IEC/EN 61000-3-2, IEC/EN 61000-3-3
	NAMUR NE21
	RCM in Australia/New Zealand
LVD	EU directive 2014/35/EU per EN 61010-1 and EN 61010-2-030
PED	EU directive 2014/68/EU per AD 2000 Code
Marine	DNV GL Type approval according to DNVGL-CP-0338 for options MC2 and MC3
RoHS	EU directive 2011/65/EU per EN 50581
SIL	Exida Certificate per IEC61508:2010 Parts 1-7 SIL 2 @ HFT=0; SIL 3 @ HFT =1

9 Ordering information

9.1 Overview MS code Supreme 34

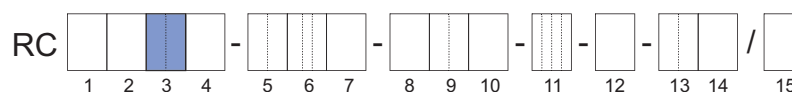

Model code Position	1.	2.	3.	4.	5.	6.	7.	8.	9.	10.	11.	12.	13.	14.	Description	Restriction
Transmitter	E														Essential (base function)	not with accuracy C6, C3, C2, 50 not with communication type and I/O JH, JJ, JK, JL, JM, JN, M2, M7
	U														Ultimate (high function)	not with accuracy E7, 70 not with display 0
Sensor	S														Supreme	–
Meter size	34														Nominal mass flow : 3 t/h (110 lb/min) Maximum mass flow: 5 t/h (180 lb/min)	not with option FE
Material wetted parts	S														Stainless steel 1.4404/316L	–
	H														Ni alloy C-22/2.4602	not with option RT, RTA, MC_
Process connection size	08														¾"	–
	15														DN15, ½"	
	20														DN20, ¾"	
	25														DN25, 1"	
	40														DN40, 1½"	
	50														DN50, 2"	
Process connection type	BA1														ASME flange class 150, suitable for ASME B16.5	see table on page [42] and the following pages
	BA2														ASME flange class 300, suitable for ASME B16.5	
	BA4														ASME flange class 600, suitable for ASME B16.5	
	CA4														ASME flange class 600, suitable for ASME B16.5, ring joint	
	BD4														EN flange PN 40, suitable for EN 1092-1 form B1	not with option WPA, RTA, PTA, P20 see table on page [45] and the following pages
	ED4														EN flange PN 40, suitable for EN 1092-1 form E, spigot	
	FD4														EN flange PN 40, suitable for EN 1092-1 form F, recess	
	GD4														EN flange PN 40, suitable for EN 1092-1 form D, safety grooves	
	BD6														EN flange PN 100, suitable for EN 1092-1 form B1	
	ED6														EN flange PN 100, suitable for EN 1092-1 form E, spigot	
	FD6														EN flange PN 100, suitable for EN 1092-1 form F, recess	
	GD6														EN flange PN 100, suitable for EN 1092-1 form D, safety grooves	
	BJ1														JIS flange 10K, suitable for JIS B 2220	not with option WPA, RTA, PTA, P20
	BJ2														JIS flange 20K, suitable for JIS B 2220	see table on page [49] and the following pages
BP1														JPI flange class 150	not with option WPA, RTA, PTA, P20	
BP2														JPI flange class 300	see table on page [51] and the following pages	
BP4														JPI flange class 600	see table on page [51] and the following pages	
TG9														Process connection with internal thread G	not with option WPA, RTA, PTA, P20 see table on page [52]	
TT9														Process connection with internal thread NPT	not with option WPA, RTA, PTA, P20 see table on page [52]	
Sensor housing material	0														Stainless steel 1.4301/304, 1.4404/316L	–
	1														Stainless steel 1.4404/316L	–
Medium temperature range	0														Standard, integral type: -50 – 150 °C (-58 – 302 °F), remote type: -70 – 150 °C (-94 – 302 °F)	–
	2														Mid-range: -70 – 230 °C (-94 – 446 °F)	not with accuracy C2 not with design and housing 0, 2, A, E, J not with option RB
	3														High: 0 – 350 °C (32 – 662 °F)	not with design and housing 0, 2, A, E, J not with option RB, MC_

Model code Position	1.	2.	3.	4.	5.	6.	7.	8.	9.	10.	11.	12.	13.	14.	Description	Restriction
Mass flow and density accuracy									E7						Liquid: 0.2 % maximum mass flow deviation D_{flat} , 4 g/l density deviation	not with transmitter U
									D7						Liquid: 0.15 % maximum mass flow deviation D_{flat} , 4 g/l density deviation	–
									C6						Liquid: 0.1 % maximum mass flow deviation D_{flat} , 3 g/l density deviation	not with transmitter E
									C3						Liquid: 0.1 % maximum mass flow deviation D_{flat} , 1 g/l density deviation	not with transmitter E not with option RT, RTA
									C2						Liquid: 0.1 % maximum mass flow deviation D_{flat} , 0.5 g/l density deviation	not with transmitter E, medium temperature range 2 not with option RT, RTA
									70						Gas: 0.75% maximum mass flow deviation D_{flat} .	not with transmitter U not with option CST, AC_, C52
									50						Gas: 0.5% maximum mass flow deviation D_{flat} .	not with transmitter E not with option CST, AC_, C52
Design and housing									0						Integral type with "urethane-cured polyester powder coating" coated aluminum transmitter housing	not with medium temperature range 2, 3
									2						Integral type with "corrosion protection coating" coated aluminum transmitter housing	not with option T_., L_., MC_, Y_.
									A						Remote type with "urethane-cured polyester powder coating" coated aluminum transmitter housing and standard neck sensor	not with medium temperature range 2, 3 not with option RB, T_.
									B						Remote type with "urethane-cured polyester powder coating" coated aluminum transmitter housing and long neck sensor	not with option RB
									E						Remote type with "corrosion protection coating" coated aluminum transmitter housing and standard neck sensor	not with medium temperature range 2, 3 not with option RB, T_.
									F						Remote type with "corrosion protection coating" coated aluminum transmitter housing and long neck sensor	not with option RB
									J						Remote type stainless steel transmitter and standard neck sensor	not with medium temperature range 2, 3 not with Ex approval KF21, SF21, UF21, NF21, QF21 not with option RB, T_.
Ex approval									NN00						None	not with communication type and I/O JP, JQ, JR, JS
									KF21						ATEX, explosion group IIC and IIIC	not with design and housing J, K
									KF22						ATEX, explosion group IIB and IIIC	–
									SF21						IECEX, explosion group IIC and IIIC	not with design and housing J, K
									SF22						IECEX, explosion group IIB and IIIC	–
									FF11						FM, groups A, B, C, D, E, F, G	not with cable entries 4
									FF12						FM, groups C, D, E, F, G	not with option Y_.
									UF21						INMETRO, explosion group IIC and IIIC	not with design and housing J, K
									UF22						INMETRO, explosion group IIB and IIIC	–
									NF21						NEPSI, explosion group IIC and IIIC	not with design and housing J, K only with option CN
									NF22						NEPSI, explosion group IIB and IIIC	only with option CN
									QF21						PESO, explosion group IIC	not with design and housing J, K
Cable entries									2						ANSI 1/2" NPT	–
									4						ISO M20x1.5	not with Ex approval FF11 or FF12

Model code	1.	2.	3.	4.	5.	6.	7.	8.	9.	10.	11.	12.	13.	14.	Description	Restriction
Position																
Communication type and I/O														JA	1 active current output HART, 1 passive pulse or status output	not with option CGC, C52
														JB	2 active current outputs one with HART, 2 passive pulse or status outputs	
														JC	2 active current outputs one with HART, 1 passive pulse or status output, 1 voltage-free status input	
														JD	1 active current output HART, 2 passive pulse or status outputs, 1 passive status output	
														JE	1 active current output HART, 2 passive pulse or status outputs, 1 voltage-free status input	
														JF	1 active current output HART, 1 passive pulse or status output, 1 active pulse or status output with pull-up resistor, 1 voltage-free status input	
														JG	1 active current output HART, 1 passive pulse or status output, 1 active pulse or status output, 1 voltage-free status input	
														JH	1 active current output HART, 1 passive pulse or status output, 1 passive current output, 1 active current input	not with transmitter E, not with option C52
														JJ	1 active current output HART, 2 passive pulse or status outputs, 1 active current input	
														JK	1 active current output HART, 1 passive pulse or status output, 1 voltage-free status input, 1 active current input	
														JL	1 active current output HART, 1 passive pulse or status output, 1 passive current output, 1 passive current input	
														JM	1 active current output HART, 2 passive pulse or status outputs, 1 passive current input	
														JN	1 active current output HART, 1 passive pulse or status output, 1 voltage-free status input, 1 passive current input	
														JP	2 passive current outputs one with HART, 1 passive pulse or status output	
														JQ	2 passive current outputs one with HART, 2 passive pulse or status outputs	not with Ex approval NN00 not with option CGC, C52, MC2, MC3
														JR	2 passive current outputs one with HART, 1 passive NAMUR pulse or status output	
														JS	2 passive current outputs one with HART, 2 passive NAMUR pulse or status outputs	
														M0	Modbus output, 1 passive pulse or status output	not with option CGC, PS
														M2	Modbus output, 1 passive pulse or status output, 1 active current input	not with transmitter E, not with option PS
														M3	Modbus output, 2 passive pulse or status outputs	not with option CGC , PS
													M4	Modbus output, 1 passive pulse or status output, 1 active pulse or status output		
													M5	Modbus output, 1 passive pulse or status output, 1 active pulse or status output with pull-up resistor		
													M6	Modbus output, 1 passive pulse or status output, 1 active current output		
													M7	Modbus output, 1 passive pulse or status output, 1 passive current input	not with transmitter E, not with option PS	
Display														0	No display	not with transmitter U
														1	With display	-

9.2 Overview MS code Supreme 36

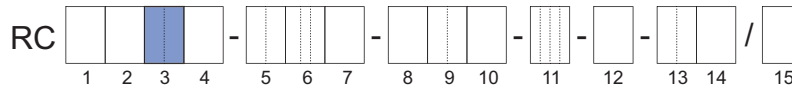

Model code Position	1.	2.	3.	4.	5.	6.	7.	8.	9.	10.	11.	12.	13.	14.	Description	Restriction
Transmitter	E														Essential (base function)	not with accuracy C5, C3, C2, 50 not with communication type and I/O JH, JJ, JK, JL, JM, JN, M2, M7 not with option CST, AC_, CGC, C52
	U														Ultimate (high function)	not with accuracy E7, 70 not with display 0
Sensor	S														Supreme	–
Meter size	36														Nominal mass flow : 10 t/h (370 lb/min) Maximum mass flow: 17 t/h (620 lb/min)	–
Material wetted parts	S														Stainless steel 1.4404/316L	–
	H														Ni alloy C-22/2.4602	not with option RT, RTA, MC_, FE
Process connection size	25														DN25, 1"	–
	40														DN40, 1½"	
	50														DN50, 2"	
Process connection type	BA1														ASME flange class 150, suitable for ASME B16.5	see table on page [42] and the following pages
	BA2														ASME flange class 300, suitable for ASME B16.5	
	BA4														ASME flange class 600, suitable for ASME B16.5	
	CA4														ASME flange class 600, suitable for ASME B16.5, ring joint	not with option WPA, RTA, PTA, P20 see table on page [45] and the following pages
	BD4														EN flange PN 40, suitable for EN 1092-1 form B1	
	ED4														EN flange PN 40, suitable for EN 1092-1 form E, spigot	
	FD4														EN flange PN 40, suitable for EN 1092-1 form F, recess	
	GD4														EN flange PN 40, suitable for EN 1092-1 form D, safety grooves	
	BD5														EN flange PN 63, suitable for EN 1092-1 form B1	
	ED5														EN flange PN 63, suitable for EN 1092-1 form E, spigot	
	FD5														EN flange PN 63, suitable for EN 1092-1 form F, recess	
	GD5														EN flange PN 63, suitable for EN 1092-1 form D, safety grooves	
	BD6														EN flange PN 100, suitable for EN 1092-1 form B1	
	ED6														EN flange PN 100, suitable for EN 1092-1 form E, spigot	
	FD6														EN flange PN 100, suitable for EN 1092-1 form F, recess	
	GD6														EN flange PN 100, suitable for EN 1092-1 form D, safety grooves	
BJ1														JIS flange 10K, suitable for JIS B 2220	not with option WPA, RTA, PTA, P20	
BJ2														JIS flange 20K, suitable for JIS B 2220	see table on page [49] and the following pages	
BP1														JPI flange class 150	not with option WPA, RTA, PTA, P20	
BP2														JPI flange class 300	–	
BP4														JPI flange class 600	see table on page [51] and the following pages	
Sensor housing material	0														Stainless steel 1.4301/304, 1.4404/316L	–
	1														Stainless steel 1.4404/316L	–
Medium temperature range	0														Standard, integral type: -50 – 150 °C (-58 – 302 °F), remote type: -70 – 150 °C (-94 – 302 °F)	–
	2														Mid-range: -70 – 230 °C (-94 – 446 °F)	not with accuracy C2 not with design and housing 0, 2, A, E, J not with option RB
	3														High: 0 – 350 °C (32 – 662 °F)	not with design and housing 0, 2, A, E, J not with option RB, MC_

Model code Position	1.	2.	3.	4.	5.	6.	7.	8.	9.	10.	11.	12.	13.	14.	Description	Restriction	
Mass flow and density accuracy										E7					Liquid: 0.2 % maximum mass flow deviation D_{flat} , 4 g/l density deviation	not with transmitter U	
										D7					Liquid: 0.15 % maximum mass flow deviation D_{flat} , 4 g/l density deviation	–	
										C5					Liquid: 0.1 % maximum mass flow deviation D_{flat} , 2 g/l density deviation	not with transmitter E	
										C3					Liquid: 0.1 % maximum mass flow deviation D_{flat} , 1 g/l density deviation		
										C2					Liquid: 0.1 % maximum mass flow deviation D_{flat} , 0.5 g/l density deviation	not with transmitter E, medium temperature range 2	
										70					Gas: 0.75 % maximum mass flow deviation D_{flat}	not with transmitter U not with option CST, AC_, C52	
										50					Gas: 0.5 % maximum mass flow deviation D_{flat}	not with transmitter E not with option CST, AC_, C52	
Design and housing										0					Integral type with "urethane-cured polyester powder coating" coated aluminum transmitter housing	not with medium temperature range 2, 3	
										2					Integral type with "corrosion protection coating" coated aluminum transmitter housing	not with option T_..., L_..., MC_, Y_...	
										A					Remote type with "urethane-cured polyester powder coating" coated aluminum transmitter housing and standard neck sensor	not with medium temperature range 2, 3 not with option RB, T_...	
										B					Remote type with "urethane-cured polyester powder coating" coated aluminum transmitter housing and long neck sensor	not with option RB	
										E					Remote type with "corrosion protection coating" coated aluminum transmitter housing and standard neck sensor	not with medium temperature range 2, 3 not with option RB, T_...	
										F					Remote type with "corrosion protection coating" coated aluminum transmitter housing and long neck sensor	not with option RB	
										J					Remote type stainless steel transmitter and standard neck sensor	not with medium temperature range 2, 3 not with Ex approval KF21, SF21, UF21, NF21, QF21 not with option RB, T_...	
										K					Remote type stainless steel transmitter and long neck sensor	not with Ex approval KF21, SF21, UF21, NF21, QF21 not with option RB	
Ex approval										NN00					None	not with communication type and I/O JP, JQ, JR, JS	
										KF21					ATEX, explosion group IIC and IIIC	not with design and housing J, K	
										KF22					ATEX, explosion group IIB and IIIC	–	
										SF21					IECEX, explosion group IIC and IIIC	not with design and housing J, K	
										SF22					IECEX, explosion group IIB and IIIC	–	
										FF11					FM, groups A, B, C, D, E, F, G	not with cable entries 4	
										FF12					FM, groups C, D, E, F, G	not with option Y_...	
										UF21					INMETRO, explosion group IIC and IIIC	not with design and housing J, K	
										UF22					INMETRO, explosion group IIB and IIIC	–	
										NF21					NEPSI, explosion group IIC and IIIC	not with design and housing J, K only with option CN	
										NF22					NEPSI, explosion group IIB and IIIC	only with option CN	
										QF21					PESO, explosion group IIC	not with design and housing J, K	
										QF22					PESO, explosion group IIB	–	
	Cable entries												2				ANSI ½" NPT
											4				ISO M20x1.5	not with Ex approval FF11 or FF12	

Model code	1.	2.	3.	4.	5.	6.	7.	8.	9.	10.	11.	12.	13.	14.	Description	Restriction	
Position																	
Communication type and I/O														JA	1 active current output HART, 1 passive pulse or status output	not with option CGC, C52	
														JB	2 active current outputs one with HART, 2 passive pulse or status outputs		
														JC	2 active current outputs one with HART, 1 passive pulse or status output, 1 voltage-free status input		
														JD	1 active current output HART, 2 passive pulse or status outputs, 1 passive status output		
														JE	1 active current output HART, 2 passive pulse or status outputs, 1 voltage-free status input		
														JF	1 active current output HART, 1 passive pulse or status output, 1 active pulse or status output with pull-up resistor, 1 voltage-free status input		
														JG	1 active current output HART, 1 passive pulse or status output, 1 active pulse or status output, 1 voltage-free status input		
														JH	1 active current output HART, 1 passive pulse or status output, 1 passive current output, 1 active current input	not with transmitter E, not with option C52	
														JJ	1 active current output HART, 2 passive pulse or status outputs, 1 active current input		
														JK	1 active current output HART, 1 passive pulse or status output, 1 voltage-free status input, 1 active current input		
														JL	1 active current output HART, 1 passive pulse or status output, 1 passive current output, 1 passive current input		
														JM	1 active current output HART, 2 passive pulse or status outputs, 1 passive current input		
														JN	1 active current output HART, 1 passive pulse or status output, 1 voltage-free status input, 1 passive current input		
														JP	2 passive current outputs one with HART, 1 passive pulse or status output		
														JQ	2 passive current outputs one with HART, 2 passive pulse or status outputs	not with Ex approval NN00 not with option CGC, C52, MC2, MC3	
														JR	2 passive current outputs one with HART, 1 passive NAMUR pulse or status output		
														JS	2 passive current outputs one with HART, 2 passive NAMUR pulse or status outputs		
														M0	Modbus output, 1 passive pulse or status output	not with option CGC, PS	
														M2	Modbus output, 1 passive pulse or status output, 1 active current input	not with transmitter E, not with option PS	
														M3	Modbus output, 2 passive pulse or status outputs	not with option CGC , PS	
														M4	Modbus output, 1 passive pulse or status output, 1 active pulse or status output		
														M5	Modbus output, 1 passive pulse or status output, 1 active pulse or status output with pull-up resistor		
														M6	Modbus output, 1 passive pulse or status output, 1 active current output		
														M7	Modbus output, 1 passive pulse or status output, 1 passive current input		
	Display														0	No display	not with transmitter U
															1	With display	-

9.3 Overview MS code Supreme 38

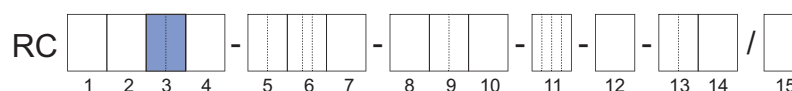

Model code Position	1.	2.	3.	4.	5.	6.	7.	8.	9.	10.	11.	12.	13.	14.	Description	Restriction
Transmitter	E														Essential (base function)	not with accuracy C5, C3, C2, 50 not with communication type and I/O JH, JJ, JK, JL, JM, JN, M2, M7 not with option CST, AC_, CGC, C52
	U														Ultimate (high function)	not with accuracy E7, 70 not with display 0
Sensor	S														Supreme	–
Meter size	38														Nominal mass flow : 32 t/h (1200 lb/min) Maximum mass flow: 50 t/h (1800 lb/min)	–
Material wetted parts	S														Stainless steel 1.4404/316L	–
	H														Ni alloy C-22/2.4602	not with option RT, RTA, MC_, FE
Process connection size	40														DN40, 1½"	–
	50														DN50, 2"	
	65														2½"	
	80														DN80, 3"	
Process connection type	BA1														ASME flange class 150, suitable for ASME B16.5	see table on page [42] and the following pages
	BA2														ASME flange class 300, suitable for ASME B16.5	
	BA4														ASME flange class 600, suitable for ASME B16.5	
	CA4														ASME flange class 600, suitable for ASME B16.5, ring joint	
	BD4														EN flange PN 40, suitable for EN 1092-1 form B1	not with option WPA, RTA, PTA, P20 see table on page [45] and the following pages
	ED4														EN flange PN 40, suitable for EN 1092-1 form E, spigot	
	FD4														EN flange PN 40, suitable for EN 1092-1 form F, recess	
	GD4														EN flange PN 40, suitable for EN 1092-1 form D, safety grooves	
	BD5														EN flange PN 63, suitable for EN 1092-1 form B1	
	ED5														EN flange PN 63, suitable for EN 1092-1 form E, spigot	
	FD5														EN flange PN 63, suitable for EN 1092-1 form F, recess	
	GD5														EN flange PN 63, suitable for EN 1092-1 form D, safety grooves	
	BD6														EN flange PN 100, suitable for EN 1092-1 form B1	
	ED6														EN flange PN 100, suitable for EN 1092-1 form E, spigot	
	FD6														EN flange PN 100, suitable for EN 1092-1 form F, recess	
	GD6														EN flange PN 100, suitable for EN 1092-1 form D, safety grooves	
BJ1														JIS flange 10K, suitable for JIS B 2220	not with option WPA, RTA, PTA, P20	
BJ2														JIS flange 20K, suitable for JIS B 2220	see table on page [49] and the following pages	
BP1														JPI flange class 150	not with option WPA, RTA, PTA, P20	
BP2														JPI flange class 300	see table on page [51] and the following pages	
BP4														JPI flange class 600		
Sensor housing material	0														Stainless steel 1.4301/304, 1.4404/316L	–
	1														Stainless steel 1.4404/316L	–
Medium temperature range	0														Standard, integral type: -50 – 150 °C (-58 – 302 °F), remote type: -70 – 150 °C (-94 – 302 °F)	–
	2														Mid-range: -70 – 230 °C (-94 – 446 °F)	not with accuracy C2 not with design and housing 0, 2, A, E, J not with option RB
	3														High: 0 – 350 °C (32 – 662 °F)	not with design and housing 0, 2, A, E, J not with option RB, MC_

Model code Position	1.	2.	3.	4.	5.	6.	7.	8.	9.	10.	11.	12.	13.	14.	Description	Restriction
Mass flow and density accuracy										E7					Liquid: 0.2 % maximum mass flow deviation D_{flat} , 4 g/l density deviation	not with transmitter U
										D7					Liquid: 0.15 % maximum mass flow deviation D_{flat} , 4 g/l density deviation	–
										C5					Liquid: 0.1 % maximum mass flow deviation D_{flat} , 2 g/l density deviation	not with transmitter E
										C3					Liquid: 0.1 % maximum mass flow deviation D_{flat} , 1 g/l density deviation	
										C2					Liquid: 0.1 % maximum mass flow deviation D_{flat} , 0.5 g/l density deviation	not with transmitter E, medium temperature range 2
										70					Gas: 0.75 % maximum mass flow deviation D_{flat}	not with transmitter U not with option CST, AC_, C52
										50					Gas: 0.5 % maximum mass flow deviation D_{flat}	not with transmitter E not with option CST, AC_, C52
Design and housing										0					Integral type with "urethane-cured polyester powder coating" coated aluminum transmitter housing	not with medium temperature range 2, 3
										2					Integral type with "corrosion protection coating" coated aluminum transmitter housing	not with option T_, L_, MC_, Y_
										A					Remote type with "urethane-cured polyester powder coating" coated aluminum transmitter housing and standard neck sensor	not with medium temperature range 2, 3 not with option RB, T_
										B					Remote type with "urethane-cured polyester powder coating" coated aluminum transmitter housing and long neck sensor	not with option RB
										E					Remote type with "corrosion protection coating" coated aluminum transmitter housing and standard neck sensor	not with medium temperature range 2, 3 not with option RB, T_
										F					Remote type with "corrosion protection coating" coated aluminum transmitter housing and long neck sensor	not with option RB
										J					Remote type stainless steel transmitter and standard neck sensor	not with medium temperature range 2, 3 not with Ex approval KF21, SF21, UF21, NF21, QF21 not with option RB, T_
									K					Remote type stainless steel transmitter and long neck sensor	not with Ex approval KF21, SF21, UF21, NF21, QF21 not with option RB	
Ex approval										NN00					None	not with communication type and I/O JP, JQ, JR, JS
										KF21					ATEX, explosion group IIC and IIIC	not with design and housing J, K
										KF22					ATEX, explosion group IIB and IIIC	–
										SF21					IECEx, explosion group IIC and IIIC	not with design and housing J, K
										SF22					IECEx, explosion group IIB and IIIC	–
										FF11					FM, groups A, B, C, D, E, F, G	not with cable entries 4
										FF12					FM, groups C, D, E, F, G	not with option Y_
										UF21					INMETRO, explosion group IIC and IIIC	not with design and housing J, K
										UF22					INMETRO, explosion group IIB and IIIC	–
										NF21					NEPSI, explosion group IIC and IIIC	not with design and housing J, K only with option CN
										NF22					NEPSI, explosion group IIB and IIIC	only with option CN
										QF21					PESO, explosion group IIC	not with design and housing J, K
									QF22					PESO, explosion group IIB	–	
Cable entries										2					ANSI ½" NPT	–
										4					ISO M20x1.5	not with Ex approval FF11 or FF12

Model code	1.	2.	3.	4.	5.	6.	7.	8.	9.	10.	11.	12.	13.	14.	Description	Restriction
Position																
Communication type and I/O														JA	1 active current output HART, 1 passive pulse or status output	not with option CGC, C52
														JB	2 active current outputs one with HART, 2 passive pulse or status outputs	
														JC	2 active current outputs one with HART, 1 passive pulse or status output, 1 voltage-free status input	
														JD	1 active current output HART, 2 passive pulse or status outputs, 1 passive status output	
														JE	1 active current output HART, 2 passive pulse or status outputs, 1 voltage-free status input	
														JF	1 active current output HART, 1 passive pulse or status output, 1 active pulse or status output with pull-up resistor, 1 voltage-free status input	
														JG	1 active current output HART, 1 passive pulse or status output, 1 active pulse or status output, 1 voltage-free status input	
														JH	1 active current output HART, 1 passive pulse or status output, 1 passive current output, 1 active current input	not with transmitter E, not with option C52
														JJ	1 active current output HART, 2 passive pulse or status outputs, 1 active current input	
														JK	1 active current output HART, 1 passive pulse or status output, 1 voltage-free status input, 1 active current input	
														JL	1 active current output HART, 1 passive pulse or status output, 1 passive current output, 1 passive current input	
														JM	1 active current output HART, 2 passive pulse or status outputs, 1 passive current input	
														JN	1 active current output HART, 1 passive pulse or status output, 1 voltage-free status input, 1 passive current input	
														JP	2 passive current outputs one with HART, 1 passive pulse or status output	
														JQ	2 passive current outputs one with HART, 2 passive pulse or status outputs	not with Ex approval NN00 not with option CGC, C52, MC2, MC3
														JR	2 passive current outputs one with HART, 1 passive NAMUR pulse or status output	
														JS	2 passive current outputs one with HART, 2 passive NAMUR pulse or status outputs	
														M0	Modbus output, 1 passive pulse or status output	not with option CGC, PS
														M2	Modbus output, 1 passive pulse or status output, 1 active current input	not with transmitter E, not with option PS
														M3	Modbus output, 2 passive pulse or status outputs	not with option CGC , PS
													M4	Modbus output, 1 passive pulse or status output, 1 active pulse or status output		
													M5	Modbus output, 1 passive pulse or status output, 1 active pulse or status output with pull-up resistor		
													M6	Modbus output, 1 passive pulse or status output, 1 active current output		
													M7	Modbus output, 1 passive pulse or status output, 1 passive current input	not with transmitter E, not with option PS	
Display														0	No display	not with transmitter U
														1	With display	-

9.4 Overview MS code Supreme 39

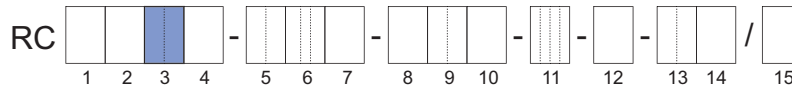

Model code Position	1.	2.	3.	4.	5.	6.	7.	8.	9.	10.	11.	12.	13.	14.	Description	Restriction
Transmitter	E														Essential (base function)	not with accuracy C5, C3, C2, 50 not with communication type and I/O JH, JJ, JK, JL, JM, JN, M2, M7 not with option CST, AC_, CGC, C52
	U														Ultimate (high function)	not with accuracy E7, 70 not with display 0
Sensor	S														Supreme	–
Meter size	39														Nominal mass flow : 100 t/h (3700 lb/min) Maximum mass flow: 170 t/h (6200 lb/min)	–
Material wetted parts	S														Stainless steel 1.4404/316L	–
	H														Ni alloy C-22/2.4602	not with option RT, RTA, MC_, FE
Process connection size	80														DN80, 3"	–
	1H														DN100, 4"	
	1Q														DN125, 5"	
Process connection type	BA1														ASME flange class 150, suitable for ASME B16.5	see table on page [42] and the following pages
	BA2														ASME flange class 300, suitable for ASME B16.5	
	BA4														ASME flange class 600, suitable for ASME B16.5	
	CA4														ASME flange class 600, suitable for ASME B16.5, ring joint	not with option WPA, RTA, PTA, P20 see table on page [45] and the following pages
	BD4														EN flange PN 40, suitable for EN 1092-1 form B1	
	ED4														EN flange PN 40, suitable for EN 1092-1 form E, spigot	
	FD4														EN flange PN 40, suitable for EN 1092-1 form F, recess	
	GD4														EN flange PN 40, suitable for EN 1092-1 form D, safety grooves	
	BD5														EN flange PN 63, suitable for EN 1092-1 form B1	
	ED5														EN flange PN 63, suitable for EN 1092-1 form E, spigot	
	FD5														EN flange PN 63, suitable for EN 1092-1 form F, recess	
	GD5														EN flange PN 63, suitable for EN 1092-1 form D, safety grooves	
	BD6														EN flange PN 100, suitable for EN 1092-1 form B1	
	ED6														EN flange PN 100, suitable for EN 1092-1 form E, spigot	
	FD6														EN flange PN 100, suitable for EN 1092-1 form F, recess	
	GD6														EN flange PN 100, suitable for EN 1092-1 form D, safety grooves	
BJ1														JIS flange 10K, suitable for JIS B 2220	not with option WPA, RTA, PTA, P20	
BJ2														JIS flange 20K, suitable for JIS B 2220	see table on page [49] and the following pages	
BP1														JPI flange class 150	not with option WPA, RTA, PTA, P20	
BP2														JPI flange class 300	see table on page [51] and the following pages	
BP4														JPI flange class 600	see table on page [51] and the following pages	
Sensor housing material	0														Stainless steel 1.4301/304, 1.4404/316L	–
	1														Stainless steel 1.4404/316L	–
Medium temperature range	0														Standard, integral type: -50 – 150 °C (-58 – 302 °F), remote type: -70 – 150 °C (-94 – 302 °F)	–
	2														Mid-range: -70 – 230 °C (-94 – 446 °F)	not with accuracy C2 not with design and housing 0, 2, A, E, J not with option RB
	3														High: 0 – 350 °C (32 – 662 °F)	not with design and housing 0, 2, A, E, J not with option RB, MC_

Model code Position	1.	2.	3.	4.	5.	6.	7.	8.	9.	10.	11.	12.	13.	14.	Description	Restriction	
Mass flow and density accuracy										E7					Liquid: 0.2 % maximum mass flow deviation D_{flat} , 4 g/l density deviation	not with transmitter U	
										D7					Liquid: 0.15 % maximum mass flow deviation D_{flat} , 4 g/l density deviation	–	
										C5					Liquid: 0.1 % maximum mass flow deviation D_{flat} , 2 g/l density deviation	not with transmitter E	
										C3					Liquid: 0.1 % maximum mass flow deviation D_{flat} , 1 g/l density deviation		
										C2					Liquid: 0.1 % maximum mass flow deviation D_{flat} , 0.5 g/l density deviation	not with transmitter E, medium temperature range 2	
										70					Gas: 0.75 % maximum mass flow deviation D_{flat}	not with transmitter U not with option CST, AC_, C52	
										50					Gas: 0.5 % maximum mass flow deviation D_{flat}	not with transmitter E not with option CST, AC_, C52	
Design and housing										0					Integral type with "urethane-cured polyester powder coating" coated aluminum transmitter housing	not with medium temperature range 2, 3	
										2					Integral type with "corrosion protection coating" coated aluminum transmitter housing	not with option T_..., L_..., MC_, Y_...	
										A					Remote type with "urethane-cured polyester powder coating" coated aluminum transmitter housing and standard neck sensor	not with medium temperature range 2, 3 not with option RB, T_...	
										B					Remote type with "urethane-cured polyester powder coating" coated aluminum transmitter housing and long neck sensor	not with option RB	
										E					Remote type with "corrosion protection coating" coated aluminum transmitter housing and standard neck sensor	not with medium temperature range 2, 3 not with option RB, T_...	
										F					Remote type with "corrosion protection coating" coated aluminum transmitter housing and long neck sensor	not with option RB	
										J					Remote type stainless steel transmitter and standard neck sensor	not with medium temperature range 2, 3 not with Ex approval KF21, SF21, UF21, NF21, QF21 not with option RB, T_...	
										K					Remote type stainless steel transmitter and long neck sensor	not with Ex approval KF21, SF21, UF21, NF21, QF21 not with option RB	
Ex approval										NN00					None	not with communication type and I/O JP, JQ, JR, JS	
										KF21					ATEX, explosion group IIC and IIIC	not with design and housing J, K	
										KF22					ATEX, explosion group IIB and IIIC	–	
										SF21					IECEX, explosion group IIC and IIIC	not with design and housing J, K	
										SF22					IECEX, explosion group IIB and IIIC	–	
										FF11					FM, groups A, B, C, D, E, F, G	not with cable entries 4	
										FF12					FM, groups C, D, E, F, G	not with option Y_...	
										UF21					INMETRO, explosion group IIC and IIIC	not with design and housing J, K	
										UF22					INMETRO, explosion group IIB and IIIC	–	
										NF21					NEPSI, explosion group IIC and IIIC	not with design and housing J, K only with option CN	
										NF22					NEPSI, explosion group IIB and IIIC	only with option CN	
										QF21					PESO, explosion group IIC	not with design and housing J, K	
										QF22					PESO, explosion group IIB	–	
	Cable entries												2				ANSI ½" NPT
											4				ISO M20x1.5	not with Ex approval FF11 or FF12	

Model code	1.	2.	3.	4.	5.	6.	7.	8.	9.	10.	11.	12.	13.	14.	Description	Restriction	
Position																	
Communication type and I/O														JA	1 active current output HART, 1 passive pulse or status output	not with option CGC, C52	
														JB	2 active current outputs one with HART, 2 passive pulse or status outputs		
														JC	2 active current outputs one with HART, 1 passive pulse or status output, 1 voltage-free status input		
														JD	1 active current output HART, 2 passive pulse or status outputs, 1 passive status output		
														JE	1 active current output HART, 2 passive pulse or status outputs, 1 voltage-free status input		
														JF	1 active current output HART, 1 passive pulse or status output, 1 active pulse or status output with pull-up resistor, 1 voltage-free status input		
														JG	1 active current output HART, 1 passive pulse or status output, 1 active pulse or status output, 1 voltage-free status input		
														JH	1 active current output HART, 1 passive pulse or status output, 1 passive current output, 1 active current input	not with transmitter E, not with option C52	
														JJ	1 active current output HART, 2 passive pulse or status outputs, 1 active current input		
														JK	1 active current output HART, 1 passive pulse or status output, 1 voltage-free status input, 1 active current input		
														JL	1 active current output HART, 1 passive pulse or status output, 1 passive current output, 1 passive current input		
														JM	1 active current output HART, 2 passive pulse or status outputs, 1 passive current input		
														JN	1 active current output HART, 1 passive pulse or status output, 1 voltage-free status input, 1 passive current input		
														JP	2 passive current outputs one with HART, 1 passive pulse or status output		
														JQ	2 passive current outputs one with HART, 2 passive pulse or status outputs	not with Ex approval NN00 not with option CGC, C52, MC2, MC3	
														JR	2 passive current outputs one with HART, 1 passive NAMUR pulse or status output		
														JS	2 passive current outputs one with HART, 2 passive NAMUR pulse or status outputs		
														M0	Modbus output, 1 passive pulse or status output	not with option CGC, PS	
														M2	Modbus output, 1 passive pulse or status output, 1 active current input	not with transmitter E, not with option PS	
														M3	Modbus output, 2 passive pulse or status outputs	not with option CGC , PS	
														M4	Modbus output, 1 passive pulse or status output, 1 active pulse or status output		
														M5	Modbus output, 1 passive pulse or status output, 1 active pulse or status output with pull-up resistor		
														M6	Modbus output, 1 passive pulse or status output, 1 active current output		
														M7	Modbus output, 1 passive pulse or status output, 1 passive current input		
	Display														0	No display	not with transmitter U
															1	With display	-

9.5 Overview options

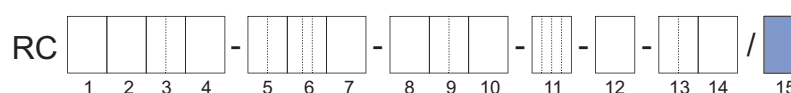

Option	Option code	Description	Restriction
Additional nameplate information	BG	Nameplate with customer-specific identification	–
Presetting of customer parameters	PS	Presetting according to customer parameters	not with communication type and I/O M_
Country-specific delivery	PJ	Delivery to Japan	–
	CN	Delivery to China	–
Concentration and petroleum measurement	AC0	Advanced concentration measurement, customer settings	not with transmitter type E not with mass flow and density accuracy 70, 50
	AC1	Advanced concentration measurement, one default data set	
	AC2	Advanced concentration measurement, two default data sets	
	AC3	Advanced concentration measurement, three default data sets	
	AC4	Advanced concentration measurement, four default data sets	
	CST	Standard concentration measurement	
	C52	Total Net Oil computing TNO	not with transmitter type E not with mass flow and density accuracy 70, 50 not with communication type and I/O J_
Rupture disc	RD	Rupture disc	not with option T_
Mass flow calibration	K2	Customer-specific 5-point mass flow calibration with factory calibration certificate (mass flow or volume flow of water). A table listing the desired calibration points must be supplied with the order.	–
	K5	Customer-specific 10-point mass flow calibration with DAkkS calibration certificate (mass flow or volume flow of water). A table listing the desired calibration points must be supplied with the order.	
Accordance with terms of order	P2	Declaration of compliance with the order 2.1 according to EN 10204	not with option P10, P11, P12, P13
	P3	Quality Inspection Certificate (Inspection Certificate 3.1 according to EN 10204)	
Material certificates	P6	Certificate of Marking Transfer and Raw Material Certificates (Inspection Certificate 3.1 according to EN 10204)	not with option P10, P11, P12, P13
Pressure testing	P8	Hydrostatic Pressure Test Certificate (Inspection Certificate 3.1 according to EN 10204)	not with option P10, P12, P13, P14
Surfaces free of oil and grease	H1	Degreasing of wetted surfaces according to ASTM G93-03 (Level C), including test report	–

Option	Option code	Description	Restriction
Welding certificates	WP	WPS according to DIN EN ISO 15609-1	not with option P13, P14, P15, P20
		WPQR according to DIN EN ISO 15614-1	
		WQC according to DIN EN 287-1 or DIN EN ISO 6906-4	
	WPA	Welding procedures and Certificate according to ASME IX	not with option P12, P13, P14, P20 only with process connection type BA_ or CA_
Calibration certificate	L2	The certificate confirms that the delivered instrument has undergone a calibration traceable to national standards, including a list of working standards used for calibration. Language: English/Japanese	-
	L3	The certificate confirms that the delivered instrument has undergone a calibration traceable to national standards, including a list of primary standards to which the delivered product is traceable. Language: English/Japanese	
	L4	The certificate confirms that the delivered instrument has undergone a calibration traceable to national standards and that the calibration system of Rota Yokogawa is traceable to national standards. Language: English/Japanese	
X-ray inspection of flange weld seam	RT	X-ray inspection of flange weld seam according to DIN EN ISO 17636-1/B Evaluation according to AD 2000 HP 5/3 and DIN EN ISO 5817/C, including certificate	not with material wetted parts H not with option P15, P20 not with Supreme 34 for mass flow and density accuracy C2, C3
	RTA	X-ray test according to ASME V	not with material wetted parts H not with option P12, P13, P14, P20 not with Supreme 34 for mass flow and density accuracy C2, C3 only with process connection type BA_ or CA4
Dye penetration test of weld seams	PT	Dye penetration test of process connection weld seams according to DIN EN ISO 3452-1, including certificate	not with option P12, P13, P15, P20
	PTA	Dye Penetrant test of flange welding according to ASME V	not with option P12, P13, P14, P20 only with process connection type BA_ or CA_
Ferrite testing	FE	Ferrite test for flange welding acc. DIN EN ISO 8249	not with meter size 34 not with material wetted parts H

Option	Option code	Description	Restriction	
Transmitter housing rotated 180°	RB	Alignment of transmitter housing rotated 180°	not with design and housing A, B, E, F, J, K not with medium temperature range 2, 3 not with option T_ _	
Insulation and heat tracing	T10	Insulation	not with design and housing 0, 2, A, E, J not with option RD, RB, P15, MC_	
	T21	Insulation and heat tracing, ½" ASME class 150		
	T22	Insulation and heat tracing, ½" ASME class 300		
	T26	Insulation and heat tracing, DN15, PN40		
	T31	Insulation, heat tracing with ventilation, ½" ASME class 150		
	T32	Insulation, heat tracing with ventilation, ½" ASME class 300		
Insulation and heat tracing	T36	Insulation, heat tracing with ventilation, DN15, PN40		
Measurement of heat quantity	CGC	Measurement of the total transported energy content of a fuel in connection with a sensor for determining the fuel's calorific value (e.g., a gas chromatograph, not included in scope of delivery)	not with transmitter type E only with communication type and I/O JH, JJ, JK, JL, JM, JN, M2, M7	
Sensor cable type and length	L000	Separate order for standard sensor cable	not with design and housing 0, 2 not with option MC_	
	L005	5 meter (16.4 ft) remote sensor cable terminated std. gray / Ex blue		
	L010	10 meter (32.8 ft) remote sensor cable terminated std. gray / Ex blue		
	L015	15 meter (49.2 ft) remote sensor cable terminated std. gray / Ex blue		
	L020	20 meter (65.6 ft) remote sensor cable terminated std. gray / Ex blue		
	L030	30 meter (98.4 ft) remote sensor cable terminated std. gray / Ex blue		
	Y000	Separate ordered remote fire retardant sensor cable	not with design and housing 0, 2; Ex approval FF11, FF12	
	Y005	5 meter (16.4 ft) remote fire retardant sensor cable not terminated		
	Y010	10 meter (32.8 ft) remote fire retardant sensor cable not terminated		
	Y015	15 meter (49.2 ft) remote fire retardant sensor cable not terminated		
	Y020	20 meter (65.6 ft) remote fire retardant sensor cable not terminated		
	Y030	30 meter (98.4 ft) remote fire retardant sensor cable not terminated		

Option	Option code	Description	Restriction
Marine Approval	MC2	Marine approval according to DNV GL piping class 2	not with medium temperature range 3, material wetted parts H, design and housing 0, 2, communication type and I/O JP, JQ, JR, JS
	MC3	Marine approval according to DNV GL piping class 3	not with option T... only with option Y... in case of thermal oil applications option RT or RTA is mandatory
Combined certificate	P10	Combination of: <ul style="list-style-type: none"> ▪ P3: Quality Inspection Certificate ▪ P6: Certificate of Marking Transfer and Raw Material Certificates ▪ P8: Hydrostatic Pressure Test Certificate 	not with option P3, P6, P8
	P11	Combination of: <ul style="list-style-type: none"> ▪ P3: Quality Inspection Certificate ▪ P6: Certificate of Marking Transfer and Raw Material Certificates ▪ PM: Positive Material Identification of wetted parts 	not with option P3, P6, PM
	P12	Combination of: <ul style="list-style-type: none"> ▪ P3: Quality Inspection Certificate ▪ P6: Certificate of Marking Transfer and Raw Material Certificates ▪ PT: Dye penetration test according to DIN EN ISO 3452-1 ▪ P8: Hydrostatic Pressure Test Certificate 	not with option P3, P6, P8, P15, WPA, RTA, PT, PTA
	P13	Combination of: <ul style="list-style-type: none"> ▪ P3: Quality Inspection Certificate ▪ P6: Certificate of Marking Transfer and Raw Material Certificates ▪ PT: Dye penetration test according to DIN EN ISO 3452-1 ▪ PM: Positive Material Identification of wetted parts ▪ P8: Hydrostatic Pressure Test Certificate ▪ WP: Welding certificates 	not with option P3, P6, P8, P15, WP, WPA, RTA, PT, PTA, PM

Option	Option code	Description	Restriction
Combined certificate	P14	Combination of: <ul style="list-style-type: none"> PM: Positive Material Identification of wetted parts P8: Hydrostatic Pressure Test Certificate WP: Welding certificates 	not with option P8, P15, PM, WP, WPA, RTA, PTA
	P20	Combination of: <ul style="list-style-type: none"> PTA: Dye Penetrant test of flange welding according to ASME V WPA: Welding procedures and Certificates according to ASME IX RTA: X-ray test according to ASME V 	not with option WP, WPA, RT, RTA, PT, PTA only with process connection type BA_ or CA4 not with meter size 34 for mass flow and density accuracy C3, C2
Positive Material Identification of wetted parts	PM	Positive Material Identification of wetted parts, including certificate (Inspection Certificate 3.1 according to EN 10204)	not with option P11, P13, P14
Tube health check	TC	Tube health check	–
ASME B31.3 compliance	P15	ASME B31.3 compliance NORMAL FLUID SERVICE	not with option WP, RT, PT, P12, P13, P14, T_ _ only with process connection type BA_ or CA_

9.6 MS code

The MS code of the Rotamass TI is explained below.

Items 1 through 14 are mandatory entries and must be specified at the time of ordering.

Device options (item 15) can be selected and specified individually by separating them with slashes.

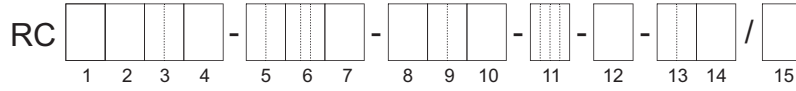

- 1. Transmitter
- 2. Sensor
- 3. Meter size
- 4. Material wetted parts
- 5. Process connection size
- 6. Process connection type
- 7. Sensor housing material
- 8. Medium temperature range
- 9. Mass flow and density accuracy
- 10. Design and housing
- 11. Ex approval
- 12. Cable entries
- 13. Communication type and I/O
- 14. Display
- 15. Options

9.6.1 Transmitter

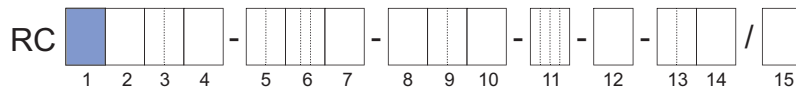

MS code	Transmitter
Position 1	
E	Essential
U	Ultimate

9.6.2 Sensor

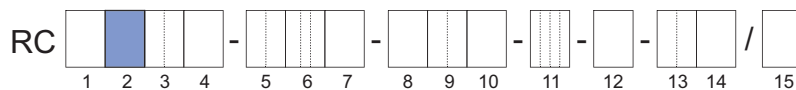

MS code	Sensor
Position 2	
S	Supreme

9.6.3 Meter size

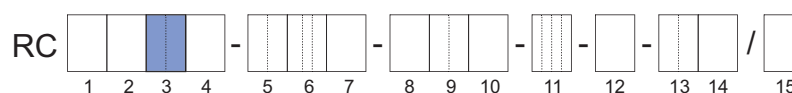

MS code Position 3	Meter size	Nominal mass flow in t/h (lb/min)	Maximum mass flow in t/h (lb/min)
34	34	3 (110)	5 (180)
36	36	10 (370)	17 (620)
38	38	32 (1200)	50 (1800)
39	39	100 (3700)	170 (6200)

9.6.4 Material wetted parts

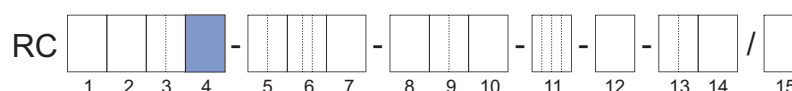

MS code Position 4	Material wetted parts
S	Stainless steel 1.4404/316L
H	Ni alloy C-22/2.4602

Non-wetted parts of the process connection are generally made of stainless steel 1.4404/316L.

9.6.5 Process connection size

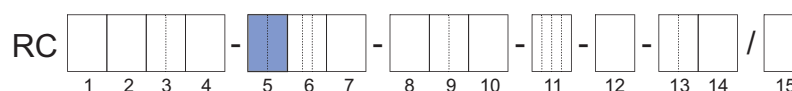

MS code Position 5	Process connection size
08	3/8"
15	DN15, 1/2"
20	DN20, 3/4"
25	DN25, 1"
40	DN40, 1 1/2"
50	DN50, 2"
65	2 1/2"
80	DN80, 3"
1H	DN100, 4"
1Q	DN125, 5"



Available sizes depend on the actual process connection, see also chapter *Process connections, dimensions and weights of sensor* [▶ 41].

9.6.6 Process connection type

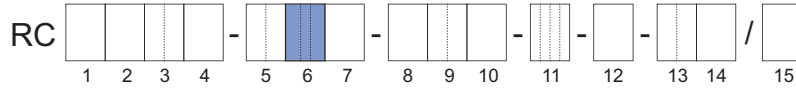

MS code Position 6	Type	Process connections
BA1	Flanges suitable for ASME B16.5	ASME flange class 150
BA2		ASME flange class 300
BA4		ASME flange class 600
CA4		ASME flange class 600, ring joint
BD4	Flange suitable for EN 1092-1	EN flange PN40, profile B1
ED4		EN flange PN40, profile E, with spigot
FD4		EN flange PN40, profile F, with recess
GD4		EN flange PN40, profile D, with safety groove
BD5		EN flange PN63, profile B1
ED5		EN flange PN63, profile E, with spigot
FD5		EN flange PN63, profile F, with recess
GD5		EN flange PN63, profile D, with safety groove
BD6		EN flange PN100, profile B1
ED6		EN flange PN100, profile E, with spigot
FD6		EN flange PN100, profile F, with recess
GD6		EN flange PN100, profile D, with safety groove
BJ1	Flange suitable for JIS B 2220	JIS flange 10K
BJ2		JIS flange 20K
BP1	Flange suitable for JPI	JPI flange class 150
BP2		JPI flange class 300
BP4		JPI flange class 600
TG9	Process connections with internal thread	Process connection with internal thread G
TT9		Process connection with internal thread NPT

9.6.7 Sensor housing material

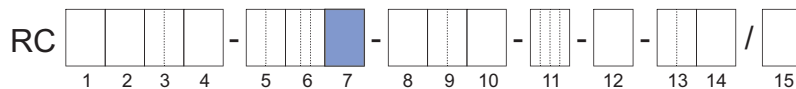

MS code Position 7	Housing material
0	Stainless steel 1.4301/304, 1.4404/316L
1	Stainless steel 1.4404/316L

9.6.8 Medium temperature range

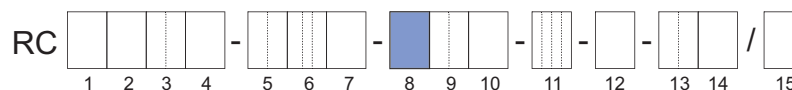

MS code Position 8	Temperature range	Medium temperature range
0	Standard	Integral type: -50 – 150 °C (-58 – 302 °F) Remote type: -70 – 150 °C (-94 – 302 °F)
2	Mid-range	-70 – 230 °C (-94 – 446 °F)
3	High	0 – 350 °C (32 – 662 °F)

For temperature range limits, see chapter *Medium temperature range* [► 28].

9.6.9 Mass flow and density accuracy

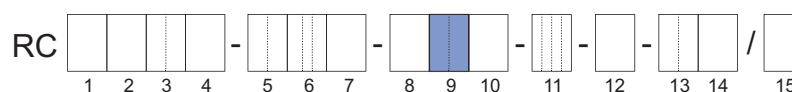

Medium	MS code Position 9	Maximum deviation		MS code Position 1
		Mass flow D_{flat} in %	Density in g/l	
Liquid	E7	0.2	4	E
	D7	0.15	4	E, U
	C6	0.1	3	U
	C5		2	U
	C3		1	U
	C2		0.5	U
Gas	70	0.75	–	E
	50	0.5	–	U

Devices with value _2 in MS code position 9 receive an additional density calibration with a corresponding certificate.

9.6.10 Design and housing

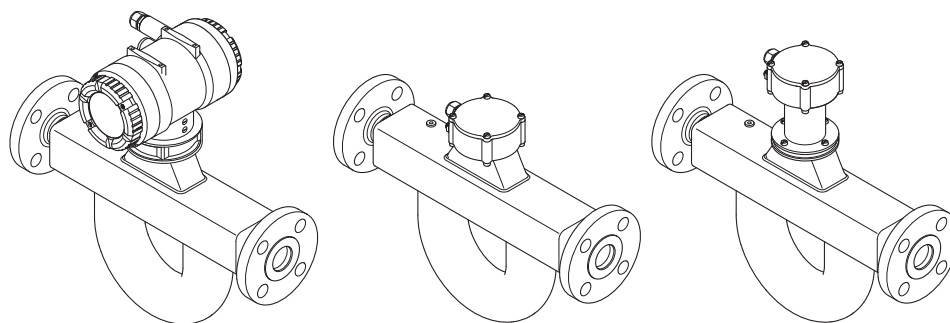
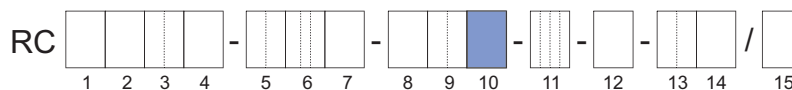

MS code Position 10	Design	Transmitter housing material	Transmitter housing coating	Sensor terminal box material	Long neck
0	Integral type	Aluminum	Standard coating	-	-
2			Corrosion protection coating		
A	Remote type	Aluminum	Standard coating	Stainless steel	No
B			Corrosion protection coating		Yes
E					
F					Yes
J	Remote type	Stainless Steel	-	Stainless steel	No
K			-		Yes

The remote type requires a connecting cable to connect sensor and transmitter. It can be selected in various lengths as a device option, see *Connecting cable type and length* [97].

9.6.11 Ex approval

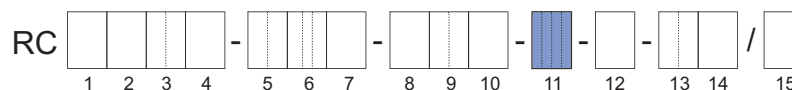

MS code Position 11	Ex approval
NN00	None
KF21	ATEX, explosion group IIC and IIIC
KF22	ATEX, explosion group IIB and IIIC
SF21	IECEx, explosion group IIC and IIIC
SF22	IECEx, explosion group IIB and IIIC
FF11	FM, group A, B, C, D, E, F, G
FF12	FM, group C, D, E, F, G
UF21	INMETRO, explosion group IIC and IIIC
UF22	INMETRO, explosion group IIB and IIIC
NF21	NEPSI, explosion group IIC and IIIC
NF22	NEPSI, explosion group IIB and IIIC
QF21	PESO, explosion group IIC
QF22	PESO, explosion group IIB

9.6.12 Cable entries

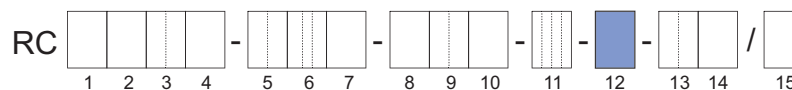

MS code Position 12	Cable entries
2	ANSI ½" NPT
4	ISO M20x1.5

9.6.13 Inputs and outputs

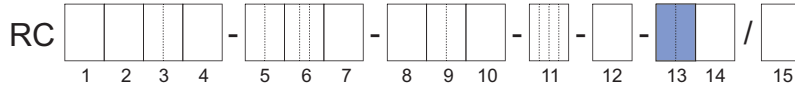

HART I/O

MS code Position 13	Connection terminal assignment				
	I/O1 +/-	I/O2 +/-	I/O3 +/-	I/O4 +/-	WP
JA	lout1 Active	P/Sout1 Passive	–	–	Write-protect
JB	lout1 Active	P/Sout1 Passive	P/Sout2 Passive	lout2 Active	Write-protect
JC	lout1 Active	P/Sout1 Passive	Sin	lout2 Active	Write-protect
JD	lout1 Active	P/Sout1 Passive	Sout Passive	P/Sout2 Passive	Write-protect
JE	lout1 Active	P/Sout1 Passive	Sin	P/Sout2 Passive	Write-protect
JF	lout1 Active	P/Sout1 Passive	Sin	P/Sout2 Active Internal pull-up resistor	Write-protect
JG	lout1 Active	P/Sout1 Passive	Sin	P/Sout2 Active	Write-protect
JH	lout1 Active	P/Sout1 Passive	lout2 Passive	lin Active	Write-protect
JJ	lout1 Active	P/Sout1 Passive	P/Sout2 Passive	lin Active	Write-protect
JK	lout1 Active	P/Sout1 Passive	Sin	lin Active	Write-protect
JL	lout1 Active	P/Sout1 Passive	lout2 Passive	lin Passive	Write-protect
JM	lout1 Active	P/Sout1 Passive	P/Sout2 Passive	lin Passive	Write-protect
JN	lout1 Active	P/Sout1 Passive	Sin	lin Passive	Write-protect

- lout1 Active or passive current output with HART communication
- lout2 Active or passive current output
- lin Active or passive current input
- P/Sout1 Passive pulse or status output
- P/Sout2 Active or passive pulse or status output
- Sin Status input
- Sout Status output

**HART I/O,
intrinsically safe**

MS code Position 13	Connection terminal assignment				
	I/O1 +/-	I/O2 +/-	I/O3 +/-	I/O4 +/-	WP
JP	lout1 Passive	P/Sout1 Passive	lout2 Passive	–	Write-protect
JQ	lout1 Passive	P/Sout1 Passive	lout2 Passive	P/Sout2 Passive	Write-protect
JR	lout1 Passive	P/Sout1 Passive NAMUR	lout2 Passive	–	Write-protect
JS	lout1 Passive	P/Sout1 Passive NAMUR	lout2 Passive	P/Sout2 Passive NAMUR	Write-protect

Intrinsically safe outputs are only available in combination with selecting Ex approval of the device, see chapter *Ex approval* [▶ 93].

Modbus I/O

MS code Position 13	Connection terminal assignment						WP
	I/O1 +/-	I/O2 +/-	I/O3 +	I/O3 -	I/O4 +	I/O4 -	
M0	–	P/Sout Passive	–	Modbus C	Modbus B	Modbus A	Write-protect
M2	lin Active	P/Sout Passive	–	Modbus C	Modbus B	Modbus A	Write-protect
M3	P/Sout Passive	P/Sout Passive	–	Modbus C	Modbus B	Modbus A	Write-protect
M4	P/Sout Active	P/Sout Passive	–	Modbus C	Modbus B	Modbus A	Write-protect
M5	P/Sout Active Internal pull-up resistor	P/Sout Passive	–	Modbus C	Modbus B	Modbus A	Write-protect
M6	lout Active	P/Sout Passive	–	Modbus C	Modbus B	Modbus A	Write-protect
M7	lin Passive	P/Sout Passive	–	Modbus C	Modbus B	Modbus A	Write-protect

lout Active current output, no HART

lin Active or passive current input

P/Sout Active or passive pulse or status output

9.6.14 Display

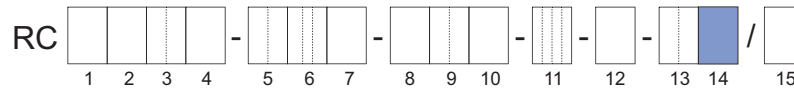

The display unit includes a slot for the microSD card.

MS code Position 14	Display
0	Without display
1	With display

Devices without a display are available for Essential transmitters only (value E in MS code position 1)

9.7 Options

Additional device options that can be combined may be selected; they are listed sequentially in MS code position 15. In this case, each device option is preceded by a slash.

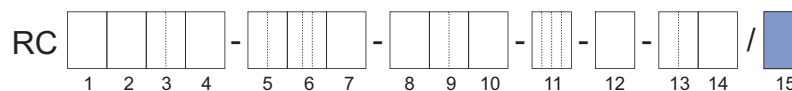

The following device options are possible:

- Connecting cable length, see chapter *Connecting cable type and length* [▶ 97]
- Customer-specific adaptation of the nameplate, see chapter *Additional nameplate information* [▶ 98]
- Flow meter presetting with customer parameters, see chapter *Presetting of customer parameters* [▶ 98]
- Concentration and petroleum measurement, see chapter *Concentration and petroleum measurement* [▶ 98]
- Insulation and heat tracing, see chapter *Insulation and heat tracing* [▶ 100]
- Certificates to be supplied, see chapter *Certificates* [▶ 101]
- Positive Material Identification of wetted parts, see chapter *Certificates* [▶ 101]
- Country -specific delivery *Country-specific delivery* [▶ 103]
- Rupture disc, see chapter *Rupture disc* [▶ 103]
- X-ray inspection of flange weld seam, see chapter *Certificates* [▶ 102]
- Tube health check, see chapter *Tube health check* [▶ 103]
- Ferrite testing, see chapter *Ferrite testing*
- Transmitter housing rotated 180°, see chapter *Transmitter housing rotated 180°* [▶ 104]
- Measurement of heat quantity, see chapter *Measurement of heat quantity* [▶ 104]
- Marine type approval, see chapter *Marine Approval* [▶ 105]

9.7.1 Connecting cable type and length

When ordering the remote type, it is mandatory to always provide the desired connecting cable length.

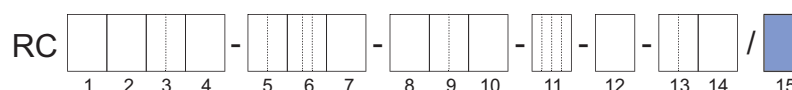

Options	Specification
L000	Separate order for standard sensor cable
L005	5 meter (16.4 ft) remote sensor cable terminated std. gray / Ex blue
L010	10 meter (32.8 ft) remote sensor cable terminated std. gray / Ex blue
L015	15 meter (49.2 ft) remote sensor cable terminated std. gray / Ex blue
L020	20 meter (65.6 ft) remote sensor cable terminated std. gray / Ex blue
L030	30 meter (98.4 ft) remote sensor cable terminated std. gray / Ex blue
Y000	Separate ordered remote fire retardant connecting cable
Y005	5 meter (16.4 ft) remote fire retardant connecting cable, not terminated
Y010	10 meter (32.8 ft) remote fire retardant connecting cable, not terminated
Y015	15 meter (49.2 ft) remote fire retardant connecting cable, not terminated
Y020	20 meter (65.6 ft) remote fire retardant connecting cable, not terminated
Y030	30 meter (98.4 ft) remote fire retardant connecting cable, not terminated

Fire retardant cable is mandatory for DNV GL type approval (Options MC2 and MC3). The minimum permissible ambient temperature for the two cable types differs (see chapter *Allowed ambient temperature for sensor* [▶ 34]). The cable type intended to be used needs to be indicated (with option L000 or Y000) even if connecting cable is ordered separately.

9.7.2 Additional nameplate information

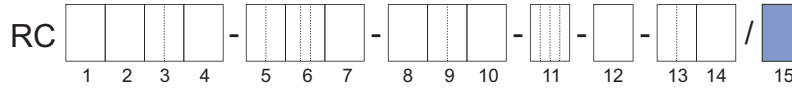

Options	Specification
BG	Nameplate with customer-specific identification

This marking (Tag No.) must be provided by the customer at the time the order is placed.

9.7.3 Presetting of customer parameters

Rotamass flow meters can be preconfigured with customer-specific data.

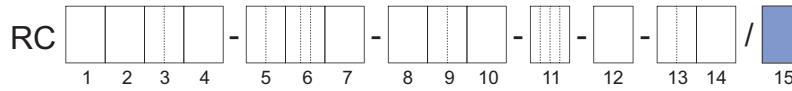

Options	Specification
PS	Presetting according to customer parameters.

9.7.4 Concentration and petroleum measurement

Concentration measurement

The standard concentration measurement (device option CST) can be used for concentration measurements of emulsions or suspensions when density of the media involved depends only on temperature.

The standard concentration measurement can also be used for many low-concentration solutions if there is only minor interaction between the liquids or if the miscibility is negligible. For questions regarding a specific application, contact the responsible Yokogawa sales organization. The appropriate density coefficients must be determined prior to using this option and input into the transmitter. To do so, the recommendation is to determine the necessary parameters from density data using DTM in the Yokogawa FieldMate program or the calculation tool included in the delivery.

The advanced concentration measurement is recommended for more complex applications, such as for liquids that interact.

Petroleum measurement function NOC (option C52)

“NOC” is an abbreviation of “Net Oil Computing” and it is an optional software function that is available only for Ultimate transmitter.

The NOC application can provide real-time measurements of water cut and includes “API” (American Petroleum Institute) correction according to API MPMS Chapter 11.1 .

Oil types	Water types
Crude	Standard Mean Ocean Water
Refined Products: Fuel, Jet Fuel, Transition, Gasoline	UNESCO 1980
Lubricating	Fresh water density by API MPMS 11.4
Alpha 60	Produced water density by API MPMS 20.1 Appendix A.1
Custom	Brine water density by El-Dessouky, Ettouy (2002)
	Custom

In addition of Water Cut, the function can calculate: Net Oil Mass flow, Net Water Mass flow, Net Oil Volume flow, Net Water Volume flow and Net corrected Oil volume flow.

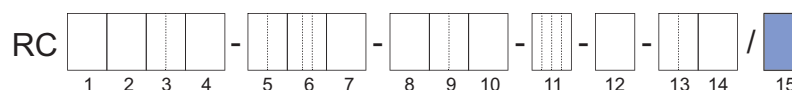

Options	Specification
CST	Standard concentration measurement
AC0	Advanced concentration measurement, customer settings
AC1	Advanced concentration measurement, one default data set
AC2	Advanced concentration measurement, two default data sets
AC3	Advanced concentration measurement, three default data sets
AC4	Advanced concentration measurement, four default data sets
C52	Total Net Oil computing TNO

These device options are not available in combination with gas measurement devices (model code position 9 with the values: 70 or 50).

Options with AC_ and C52 are available only for Ultimate transmitters (value U in MS code position 1).

Sets must be selected for AC1 – AC4 options. Not applicable to AC0 option.

Following is a table that lists possible pre-configured concentrations. The desired data sets must be requested by the customer to the Yokogawa sales organization at the time the order is placed. The customer is responsible to ensure chemical compatibility of the material of the wetted parts with the measured chemicals. For strong acids or oxidizers which attack steel pipes a variant with wetted parts made of Ni alloy C-22/2.4602 is necessary.

Set	Medium A / B	Concentration range	Unit	Temperature range in °C	Density range in kg/l	Data source for density data
C01	Sugar / Water	0 – 85	°Bx	0 – 80	0.97 – 1.45	PTB... Messages 100 5/90: "The density of watery sucrose solutions after the introduction of the international temperature scale of 1990 (ITS1990)" Table 5
C02 ¹⁾	NaOH / Water	0 – 54	WT%	0 – 100	0.95 – 1.58	D'Ans-Lax, Handbook for chemists and physicists Vol.1, 3rd edition, 1967
C03	KOH / Water	1 – 55	WT%	54 – 100	1.01 – 1.58	D'Ans-Lax, Handbook for chemists and physicists Vol.1, 3rd edition, 1967
C04	NH ₄ NO ₃ / Water	1 – 50	WT%	0 – 80	0.97 – 1.24	Table of density data on request
C05	NH ₄ NO ₃ / Water	20 – 70	WT%	20 – 100	1.04 – 1.33	Table of density data on request
C06 ¹⁾	HCl / Water	22 – 34	WT%	20 – 60	1.08 – 1.17	D'Ans-Lax, Handbook for chemists and physicists Vol.1, 3rd edition, 1967
C07	HNO ₃ / Water	50 – 67	WT%	10 – 60	1.26 – 1.40	Table of density data on request
C09 ¹⁾	H ₂ O ₂ / Water	30 – 75	WT%	4.5 – 43.5	1.00 – 1.20	Table of density data on request
C10 ¹⁾	Ethylene glycol / Water	10 – 50	WT%	-20 – 40	1.005 – 1.085	Table of density data on request
C11	Starch / Water	33 – 42.5	WT%	35 – 45	1.14 – 1.20	Table of density data on request
C12	Methanol / Water	35 – 60	WT%	0 – 40	0.89 – 0.96	Table of density data on request
C20	Alcohol / Water	55 – 100	VOL%	10 – 40	0.76 – 0.94	Table of density data on request
C21	Sugar / Water	40 – 80	°Bx	75 – 100	1.15 – 1.35	Table of density data on request
C30	Alcohol / Water	66 – 100	WT%	15 – 40	0.77 – 0.88	Standard Copersucar 1967
C37	Alcohol / Water	66 – 100	WT%	10 – 40	0.772 – 0.885	Brazilian Standard ABNT

¹⁾ We recommend using devices with wetted parts made of nickel alloy C22. Contact the Yokogawa sales organization about availability.

9.7.5 Insulation and heat tracing

These device options are available only for remote type with long neck.

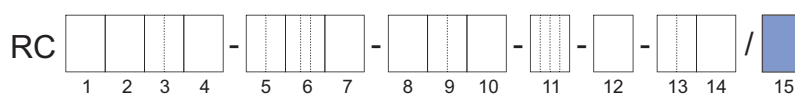

Options	Specification
T10	Insulation
T21	Insulation and heat tracing, ½" ASME class 150
T22	Insulation and heat tracing, ½" ASME class 300
T26	Insulation and heat tracing, DN15 PN40
T31	Insulation, heat tracing with ventilation, ½" ASME class 150
T32	Insulation, heat tracing with ventilation, ½" ASME class 300
T36	Insulation, heat tracing with ventilation, DN15, PN40

Insulation housings respectively heat tracings are generally made of material stainless steel 1.4301/304 or 1.4404/316L.

9.7.6 Certificates

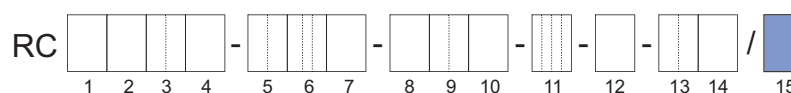

Accordance with terms of order	Options	Specification
	P2	Declaration of compliance with the order 2.1 according to EN 10204
	P3	Quality Inspection Certificate (Inspection Certificate 3.1 according to EN 10204)
Material certificates	Options	Specification
	P6	Certificate of Marking Transfer and Raw Material Certificates (Inspection Certificate 3.1 according to EN 10204)
Dye penetration test of weld seams	Options	Specification
	PT	Dye penetrant test of process connection weld seams according to DIN EN ISO 3452-1, including certificate
	PTA	Dye penetrant test of flange welding according to ASME V
Positive Material Identification of wetted parts	Options	Specification
	PM	Positive Material Identification of wetted parts, including certificate (Inspection Certificate 3.1 according to EN 10204)
Pressure testing	Options	Specification
	P8	Hydrostatic Pressure Test Certificate (Inspection Certificate 3.1 according to EN 10204)
Welding certificates	Options	Specification
	WP	Welding certificates: <ul style="list-style-type: none"> ▪ WPS according to DIN EN ISO 15609-1 ▪ WPQR according to DIN EN ISO 15614-1 ▪ WQC according to DIN EN 287-1 or DIN EN ISO 6906-4
	WPA	Welding procedures and Certificate according to ASME IX
Mass flow calibration	Only for the butt welding seam between the process connection and the flow divider.	
	Water is used as medium for calibrating the Rotamass.	
	Options	Specification
Calibration certificates	K2	Customer-specific 5-point mass flow calibration with factory calibration certificate (mass flow or volume flow of water). A table listing the desired calibration points must be supplied with the order.
	K5	Customer-specific 10-point mass flow calibration with DAkkS calibration certificate (mass flow or volume flow of water). A table listing the desired calibration points must be supplied with the order.
	Options	Specification
L2	The certificate confirms that the delivered instrument has undergone a calibration traceable to national standards, including a list of working standards used for calibration. Language: English/Japanese	
L3	The certificate confirms that the delivered instrument has undergone a calibration traceable to national standards, including a list of primary standards to which the delivered product is traceable. Language: English/Japanese	
L4	The certificate confirms that the delivered instrument has undergone a calibration traceable to national standards and that the calibration system of Rota Yokogawa is traceable to national standards. Language: English/Japanese	

Surfaces free of oil and grease

Options	Specification
H1	Degreasing of wetted surfaces according to ASTM G93-03 (Level C), including test report

X-ray inspection of flange weld seam

Options	Specification
RT	X-ray inspection of flange weld seam according to DIN EN ISO 17636-1/B Evaluation according to AD 2000 HP 5/3 and DIN EN ISO 5817/C, including certificate
RTA	X-ray test according to ASME V

This device option is not available for devices with wetted parts made of Ni alloy C-22/2.4602.

In case of the Supreme 34 model with stainless steel wetted parts, where MS code position 9 includes the value C2, D2, C3 or D3, an X-ray inspection can only be performed on one of the two process connections as a result of structural conditions.

Ferrite testing

Options	Specification
FE	Ferrite test for flange welding according to DIN EN ISO 8249

Determination of ferrite content is possible for flange weld seams according to DIN EN ISO 8249 and ANSI/AWS A4.2. The pass criterion is a ferrite number < 30. An inspection certificate is delivered with the device.

Combined certificates

Options	Specification
P10	Combination of: <ul style="list-style-type: none"> ▪ P3: Quality Inspection Certificate ▪ P6: Certificate of Marking Transfer and Raw Material Certificates ▪ P8: Hydrostatic Pressure Test Certificate
P11	Combination of: <ul style="list-style-type: none"> ▪ P3: Quality Inspection Certificate ▪ P6: Certificate of Marking Transfer and Raw Material Certificates ▪ PM: Positive Material Identification of wetted parts
P12	Combination of: <ul style="list-style-type: none"> ▪ P3: Quality Inspection Certificate ▪ P6: Certificate of Marking Transfer and Raw Material Certificates ▪ PT: Dye penetration test according to DIN EN ISO 3452-1 ▪ P8: Hydrostatic Pressure Test Certificate
P13	Combination of: <ul style="list-style-type: none"> ▪ P3: Quality Inspection Certificate ▪ P6: Certificate of Marking Transfer and Raw Material Certificates ▪ PT: Dye penetration test according to DIN EN ISO 3452-1 ▪ PM: Positive Material Identification of wetted parts ▪ P8: Hydrostatic Pressure Test Certificate ▪ WP: Welding certificates
P14	Combination of: <ul style="list-style-type: none"> ▪ PM: Positive Material Identification of wetted parts ▪ P8: Hydrostatic Pressure Test Certificate ▪ WP: Welding certificates
P20	Combination of: <ul style="list-style-type: none"> ▪ PTA: Dye Penetrant test of flange welding according to ASME V ▪ WPA: Welding procedures and Certificates according to ASME IX ▪ RTA: X-ray test according to ASME V

ASME B31.3 compliance

Options	Specification
P15	ASME B31.3 compliance NORMAL FLUID SERVICE

9.7.7 Country-specific delivery

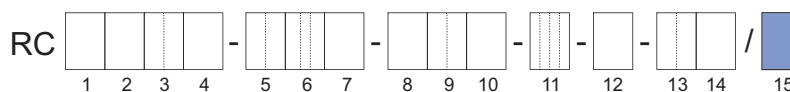

Options	Specification
PJ	Delivery to Japan
CN	Delivery to China

9.7.8 Rupture disc

In the event of a measuring tube break, complete release of process pressure via the rupture disc cannot be ensured in every case.

The rupture disc's bursting pressure is 20 bar (291 psi), the nominal diameter 8 mm (0.315 inch). If a larger nominal diameter is required, the Yokogawa sales organization may be contacted with regard to customized designs.

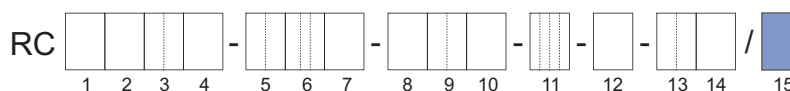

Options	Specification
RD	Rupture disc

9.7.9 Tube health check

By way of the tube health check, the transmitter can determine whether the tube properties were altered due to corrosion or deposits and, whether they could impact accuracy as a result.

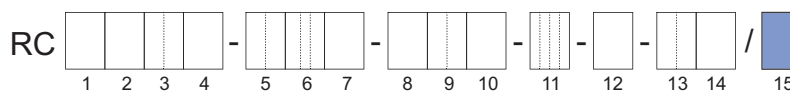

Options	Specification
TC	Tube health check

9.7.10 Transmitter housing rotated 180°

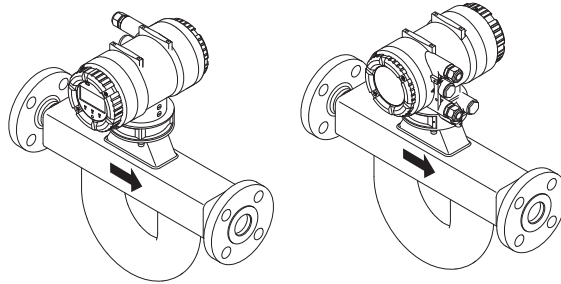
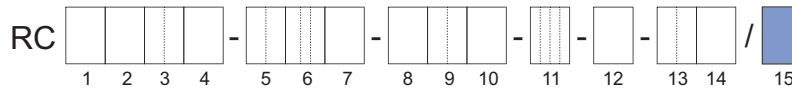

Standard

Option RB

Options	Specification
RB	Alignment of transmitter housing rotated 180°

9.7.11 Measurement of heat quantity

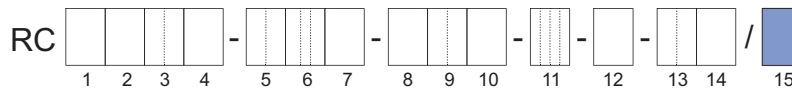

Options	Specification
CGC	<p>Measurement of the total transported energy content of a fuel in connection with a sensor for determining the fuel's calorific value (e.g., a gas chromatograph, not included in scope of delivery).</p> <p>This option is available only together with MS code position 13 JH to JN.</p>

The function allows to evaluate the total fuel calorific value of the measured fluid. The function can work with a constant value of the calorific value of the fluid, but to have a precise evaluation is suggested an additional device like a gas chromatograph not included in the supply. The external device that supplies the instantaneous calorific value is connected with the current input of the transmitter (MS code position 13: from JH to JN) Based on the mass flow, the Total Calorific Energy of the fluid is calculated as below:
 Total Calorific Energy = $\sum [(Mass\ Flow\ rate)_i \times H_i \times \Delta t]$
 where H_i is the variable Calorific Value and Δt is the time interval between two measurements. Other formula based on Volume and Corrected Volume are included in the function and can be set using the display or the configuration PC software FieldMate.

9.7.12 Marine Approval

By ordering Options MC2 and MC3 the device will carry a type approval mark by DNV GL. Ordering of fire retardant cable (Y_...) is mandatory with this option. In case of thermal oil applications option RT or RTA is mandatory. Please note that DNV GL has additional requirements regarding the process conditions as reproduced in the table below. The complete requirements can be found in the classification society's rules concerning the respective use case. Marine approval is not available for all device variants, for details see exclusions in *Overview options* [▶ 83].

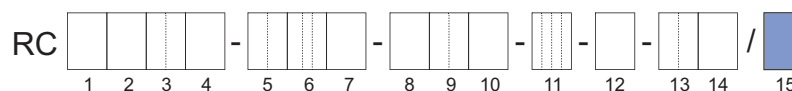

	Option			
	MC2		MC3	
Piping system for	Class II ¹⁾		Class III ¹⁾	
	p in bar	T _{pro} in °C	p in bar	T _{pro} in °C
Steam	≤ 16	≤ 300	≤ 7	≤ 170
Thermal oil	≤ 16	≤ 300	≤ 7	≤ 150
Fuel oil, lubricating oil, flammable oil	≤ 16	≤ 150	≤ 7	≤ 60
Other media ²⁾	≤ 40	≤ 300	≤ 16	≤ 200

p : Design pressure

T_{pro} : Design temperature

¹⁾ both specified conditions shall be met

²⁾ Cargo oil pipes on oil carriers and open ended pipes (drain overflows, vents, boiler escape pipes etc.) independently of the pressure and temperature, are pertaining to class III.

Options	Specification
MC2	Marine approval according to DNV GL piping class 2
MC3	Marine approval according to DNV GL piping class 3

9.7.13 Customer specific special product manufacture

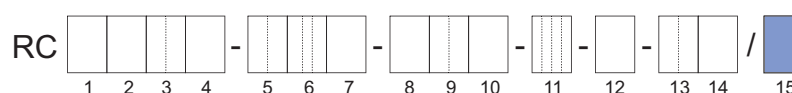

Options	Specification
Z	Deviations from the specifications in this document are possible.

9.8 Ordering Instructions

Specify the following information when ordering a product:

- Model code, suffix code, and option code
- Fluid name
- Language of the instruction manual:
 - English
 - French
 - German
 - Japanese
- Display language and language pack (Display only present for value 1 on position 14 of the MS code):
 - EN-Pack1 - English
 - DE-Pack1 - German
 - FR-Pack1 - French
 - PO-Pack1 - Portuguese
 - JA-Pack1 - Japanese
 - IT-Pack1 - Italian
 - EN-Pack2 - English
 - DE-Pack2 - German
 - RU-Pack2 - Russian
 - PL-Pack2 - Polish
 - KZ-Pack2 - Kazakh
 - EN-Pack3 - English
 - DE-Pack3 - German
 - FR-Pack3 - French
 - PO-Pack3 - Portuguese
 - IT-Pack3 - Italian
 - ES-Pack3 - Spanish
 - CN-Pack3 - Chinese
- Orientation of the display (Display only present for value 1 on position 14 of the MS code):

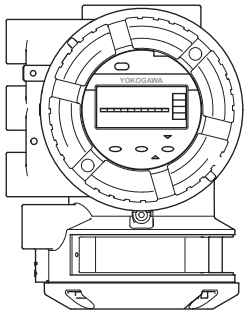
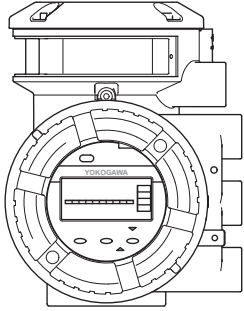
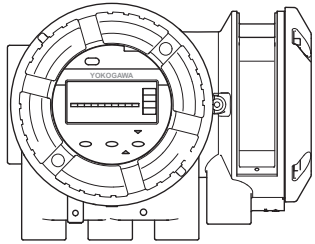
Orientation 1	Orientation 2	Orientation 3
Integral type (Horizontal installation - tubes down)	Integral type (Horizontal installation - tubes up) Remote type	Integral type (vertical installation)
		

- Tag No. to be engraved on the nameplate (option BG, up to 16 characters length)

- Software Tag No. (both short and long):
 - HART Tag No. (short): up to 8 characters length (Capital letters only)
 - HART Tag No. (long): up to 32 characters length
- Customer name for the certificates (option L2, L3, L4: up to 60 characters length)
- Advanced concentration type (option AC1 – AC4, see *Concentration and petroleum measurement* [▶ 98]):
 - C01 Sugar / Water 0 – 85 °Bx, 0 – 80 °C
 - C02 NaOH / Water 2 – 50 WT%, 0 – 100 °C
 - C03 KOH / Water 0 – 60 WT%, 54 – 100 °C
 - C04 NH₄NO₃ / Water 1 – 50 WT%, 0 – 80 °C
 - C05 NH₄NO₃ / Water 20 – 70 WT%, 20 – 100 °C
 - C06 HCl / Water 22 – 34 WT%, 20 – 40 °C
 - C07 HNO₃ / Water 50 – 67 WT%, 10 – 60 °C
 - C09 H₂O₂ / Water 30 – 75 WT%, 4 – 44 °C
 - C10 Ethylene Glycol / Water 10 – 50WT%, -20 – 40 °C
 - C11 Amylum = starch / Water 33 – 43WT%, 35 – 45 °C
 - C12 Methanol / Water 35 – 60 WT%, 0 – 40 °C
 - C20 Alcohol / Water 55 – 100 VOL%, 10 – 40 °C
 - C21 Sugar / Water 40 – 80 °Bx, 75 – 100 °C
 - C30 Alcohol / Water 66 – 100 WT%, 15 – 40 °C
 - C37 Alcohol / Water 66 – 100 WT%, 10 – 40 °C

All rights reserved. Copyright © 2017-07-14

YOKOGAWA ELECTRIC CORPORATION

Headquarters

2-9-32, Nakacho, Musashino-shi,
Tokyo, 180-8750 JAPAN

Phone : 81-422-52-5555

Branch Sales Offices

Osaka, Nagoya, Hiroshima,

Kurashiki, Fukuoka, Kitakyusyu

YOKOGAWA CORPORATION OF AMERICA

Head Office

12530 West Airport Blvd, Sugar Land,
Texas 77478, USA

Phone : 1-281-340-3800

Fax : 1-281-340-3838

Georgia Office

2 Dart Road, Newnan, Georgia 30265, USA

Phone : 1-800-888-6400/ 1-770-253-7000

Fax : 1-770-254-0928

YOKOGAWA AMERICA DO SUL LTDA.

Praca Acapulco, 31 - Santo Amaro, São Paulo/SP,
BRAZIL, CEP-04675-190

Phone : 55-11-5681-2400

Fax : 55-11-5681-4434

YOKOGAWA EUROPE B. V.

Euroweg 2, 3825 HD Amersfoort,

THE NETHERLANDS

Phone : 31-88-4641000

Fax : 31-88-4641111

YOKOGAWA ELECTRIC CIS LTD.

Grokholskiy per 13 Building 2, 4th Floor 129090,

Moscow, RUSSIA

Phone : 7-495-737-7868

Fax : 7-495-737-7869

YOKOGAWA CHINA CO., LTD.

3F Tower D Cartelo Crocodile Building,

No.568 West Tianshan Road,

Shanghai 200335, CHINA

Phone : 86-21-62396262

Fax : 86-21-62387866Z

YOKOGAWA ELECTRIC KOREA CO., LTD.

(Yokogawa B/D, Yangpyeong-dong 4-Ga),

21, Seonyu-ro 45-gil, Yeongdeungpo-gu,

Seoul, 150-866, KOREA

Phone : 82-2-2628-6000

Fax : 82-2-2628-6400

YOKOGAWA ENGINEERING ASIA PTE. LTD.

5 Bedok South Road, Singapore 469270,

SINGAPORE

Phone : 65-6241-9933

Fax : 65-6241-2606

YOKOGAWA INDIA LTD.

Plot No.96, Electronic City Complex,

Hosur Road, Bangalore - 560 100,

INDIA

Phone : 91-80-4158-6000

Fax : 91-80-2852-1442

YOKOGAWA AUSTRALIA PTY. LTD.

Tower A, 112-118 Talavera Road,

Macquarie Park NSW 2113,

AUSTRALIA

Phone : 61-2-8870-1100

Fax : 61-2-8870-1111

YOKOGAWA MIDDLE EAST & AFRICA B.S.C.(C)

P. O. Box 10070, Manama, Building 577,

Road 2516, Busaitteen 225, Muharraq,

Kingdom of SAUDI ARABIA

Phone : 973-17358100

Fax : 973-17336100



YOKOGAWA ◆